

**RETAINED PROTEIN DOMAINS**  
reading frame unclear



**SUPPORTING READ COUNT**

Split reads = 3501  
Discordant mates = 40

- translocation
- duplication
- deletion
- inversion

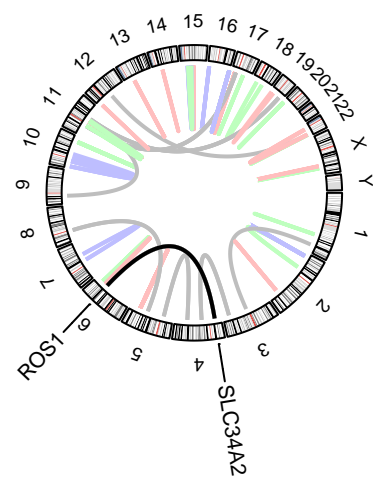
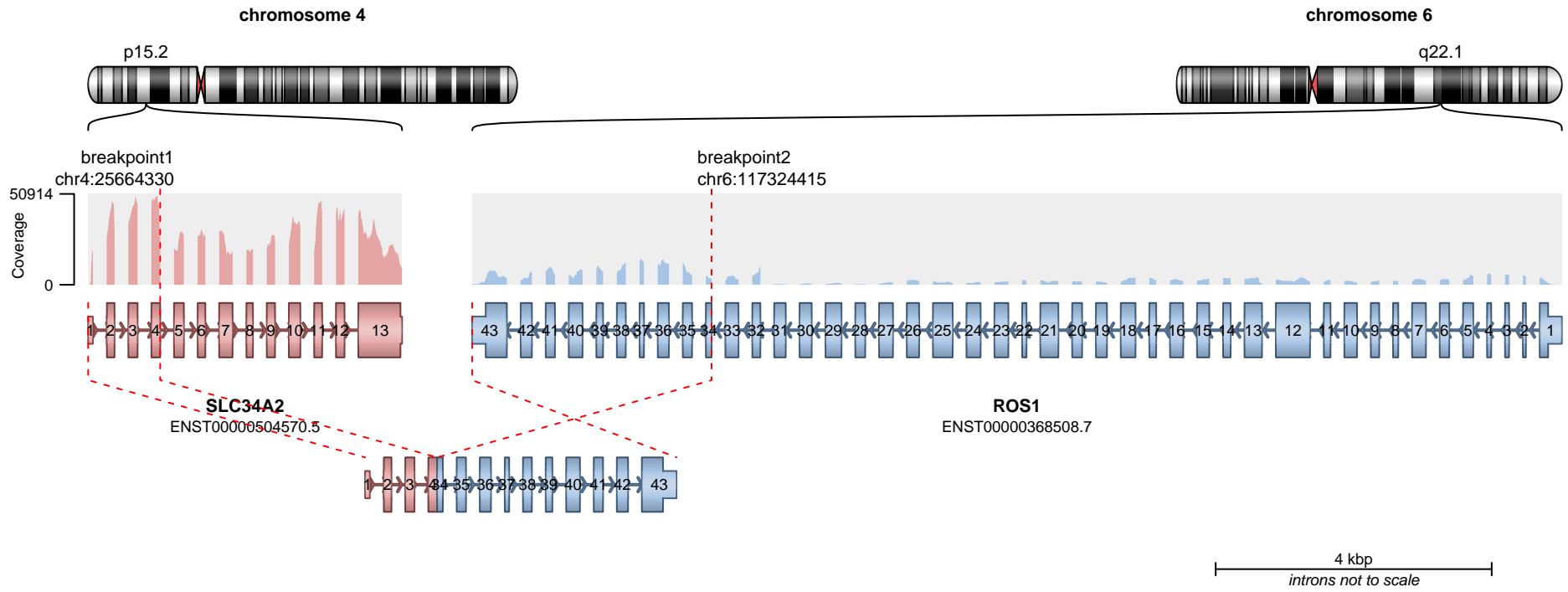

**RETAINED PROTEIN DOMAINS**  
reading frame unclear



**SUPPORTING READ COUNT**

Split reads = 226  
Discordant mates = 13

- translocation
- duplication
- deletion
- inversion

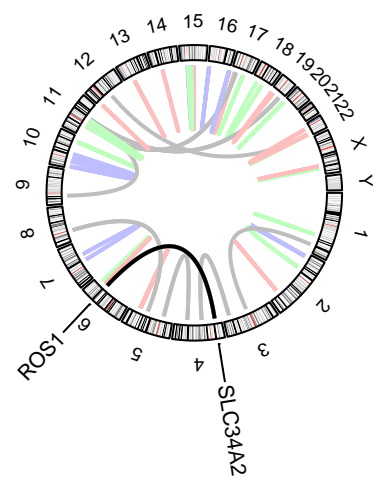
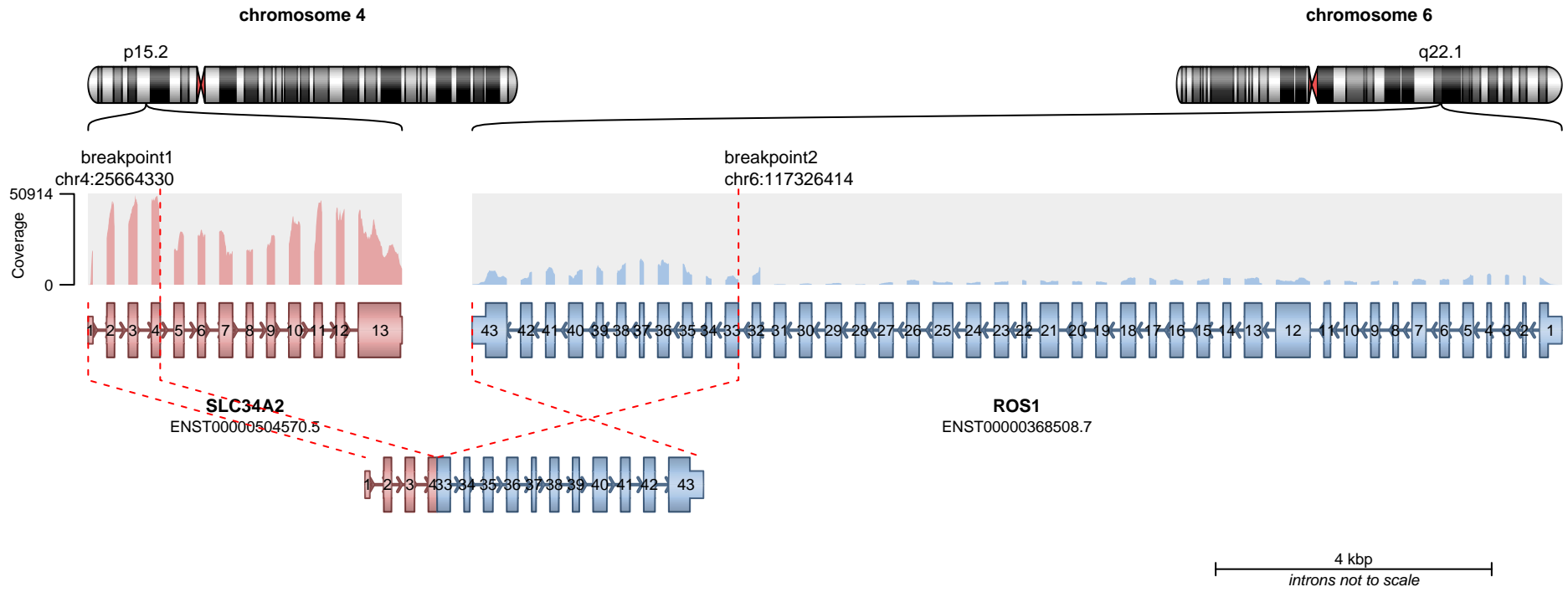

— translocation    — deletion  
— duplication    — inversion

**RETAINED PROTEIN DOMAINS**  
reading frame unclear

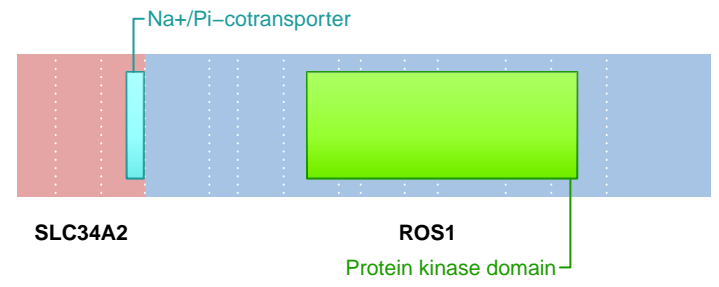

**SUPPORTING READ COUNT**

Split reads = 29  
Discordant mates = 14

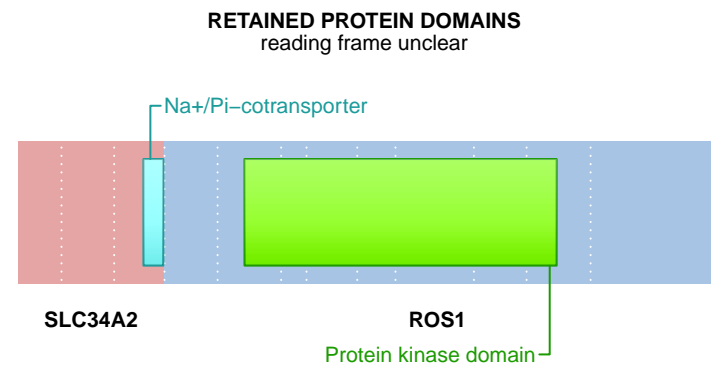
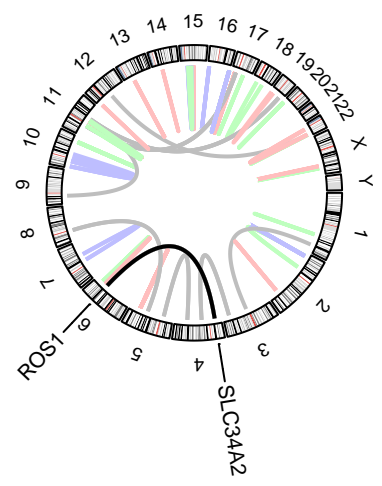
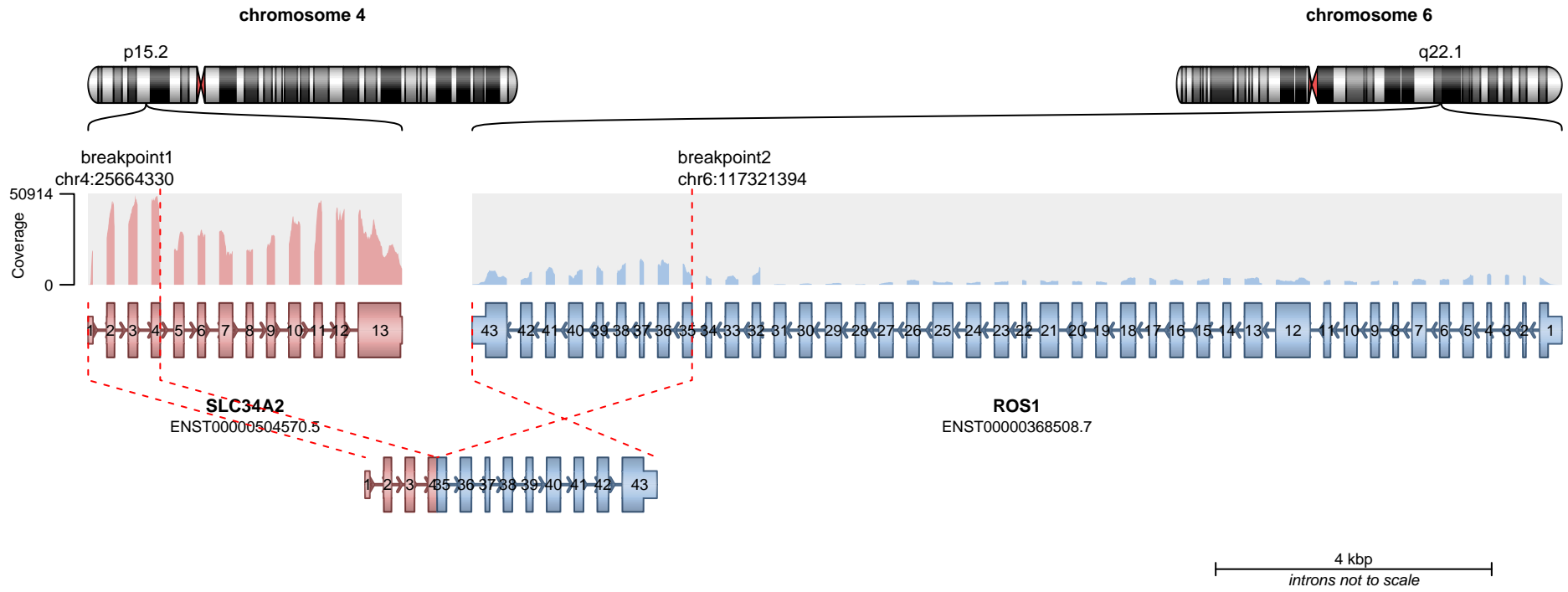

**SUPPORTING READ COUNT**

Split reads = 6  
Discordant mates = 0

- translocation
- duplication
- deletion
- inversion

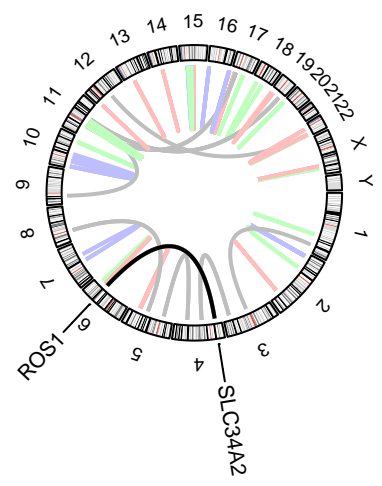
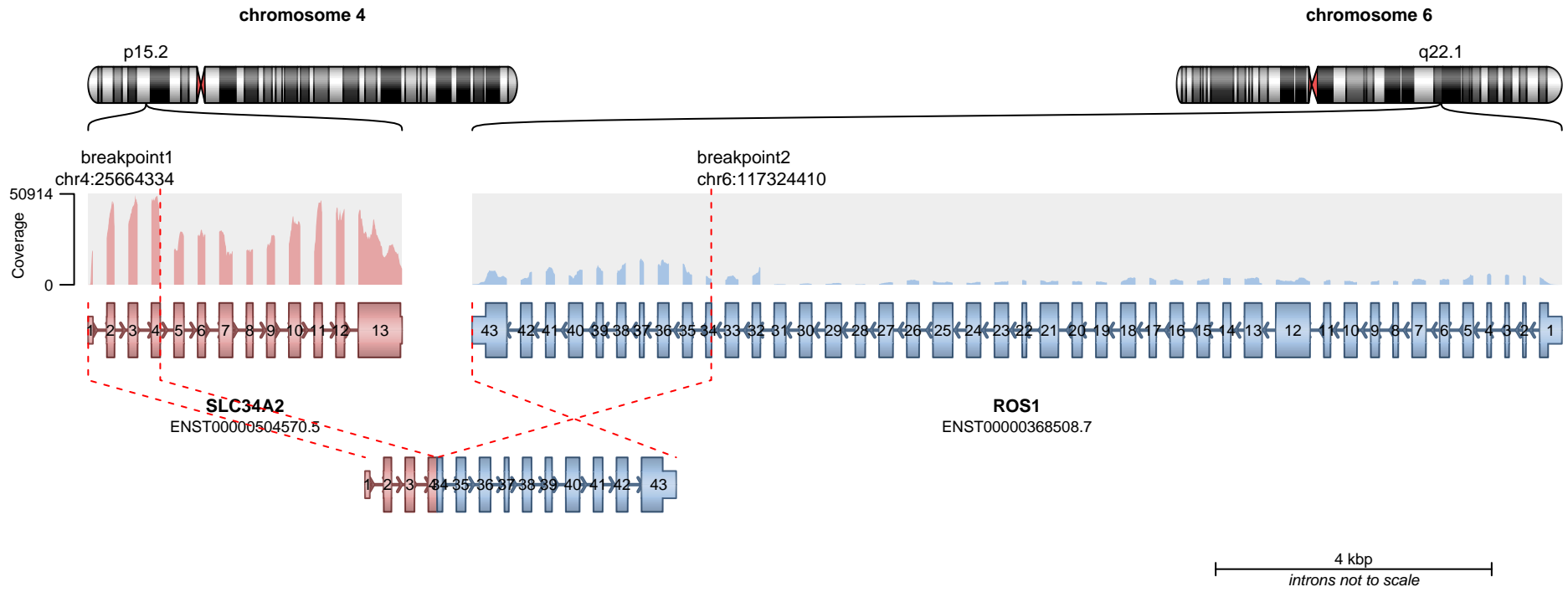

**RETAINED PROTEIN DOMAINS**  
reading frame unclear

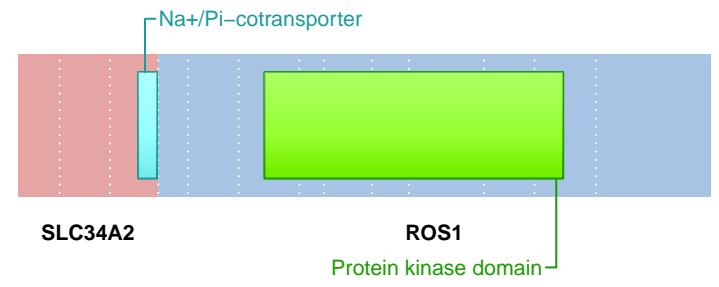

**SUPPORTING READ COUNT**

Split reads = 3  
Discordant mates = 4

- translocation
- duplication
- deletion
- inversion

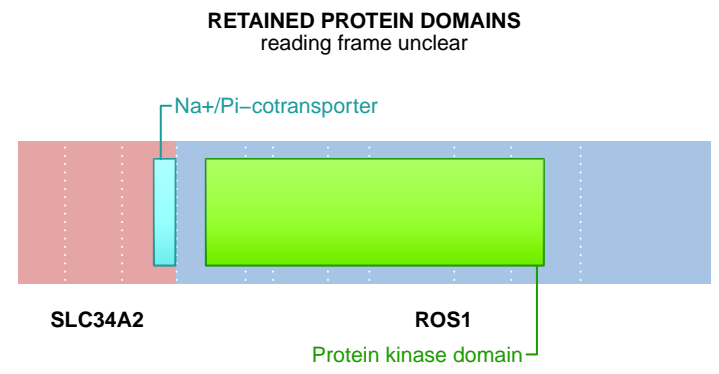
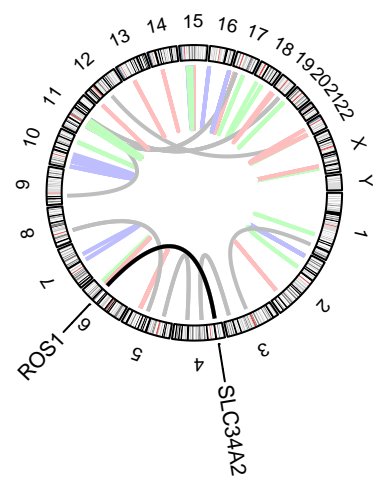
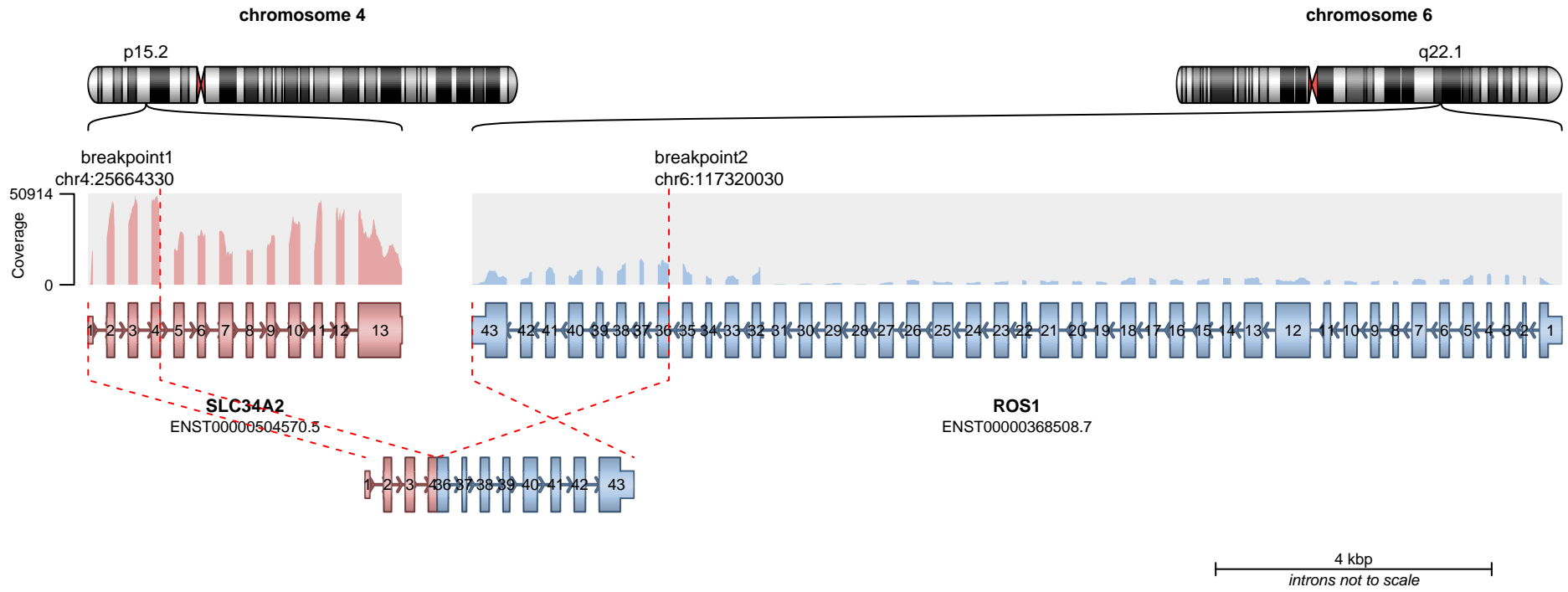

**SUPPORTING READ COUNT**

Split reads = 1

Discordant mates = 0

- translocation
- duplication
- deletion
- inversion

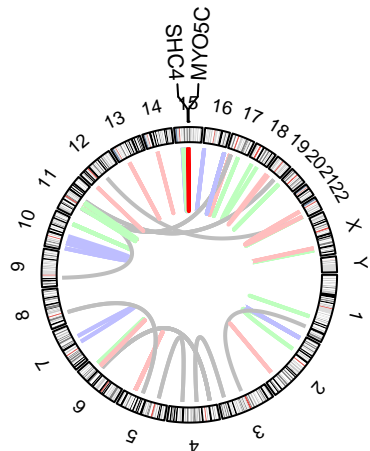
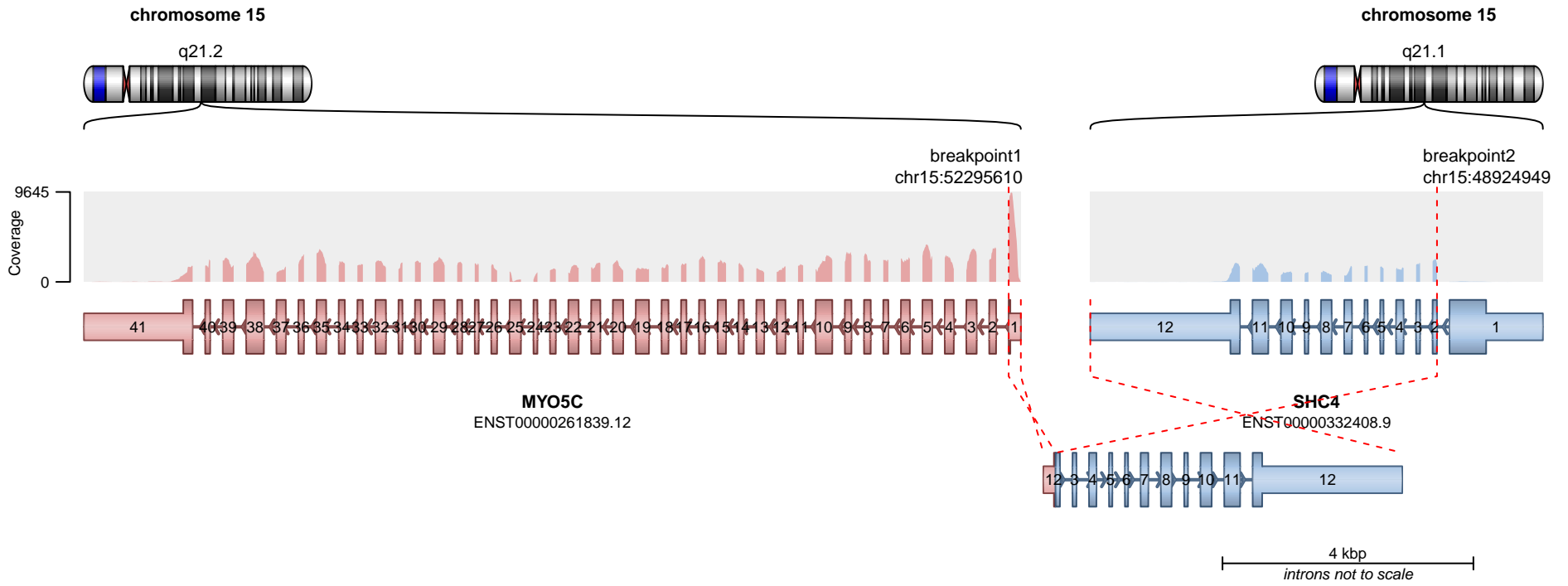

**RETAINED PROTEIN DOMAINS**  
reading frame unclear

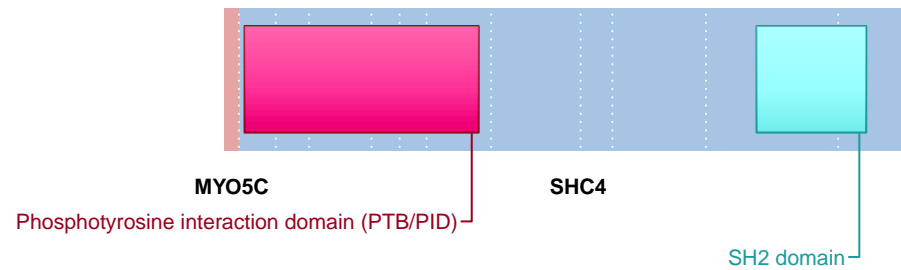

**SUPPORTING READ COUNT**

Split reads = 936  
Discordant mates = 27

- translocation
- duplication
- deletion
- inversion

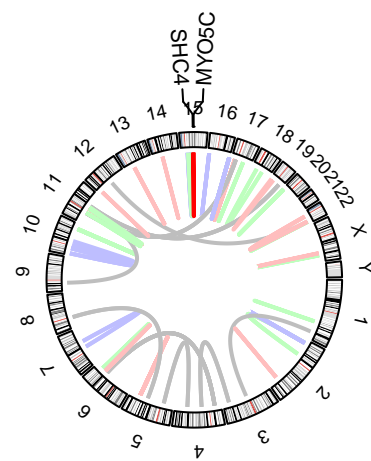
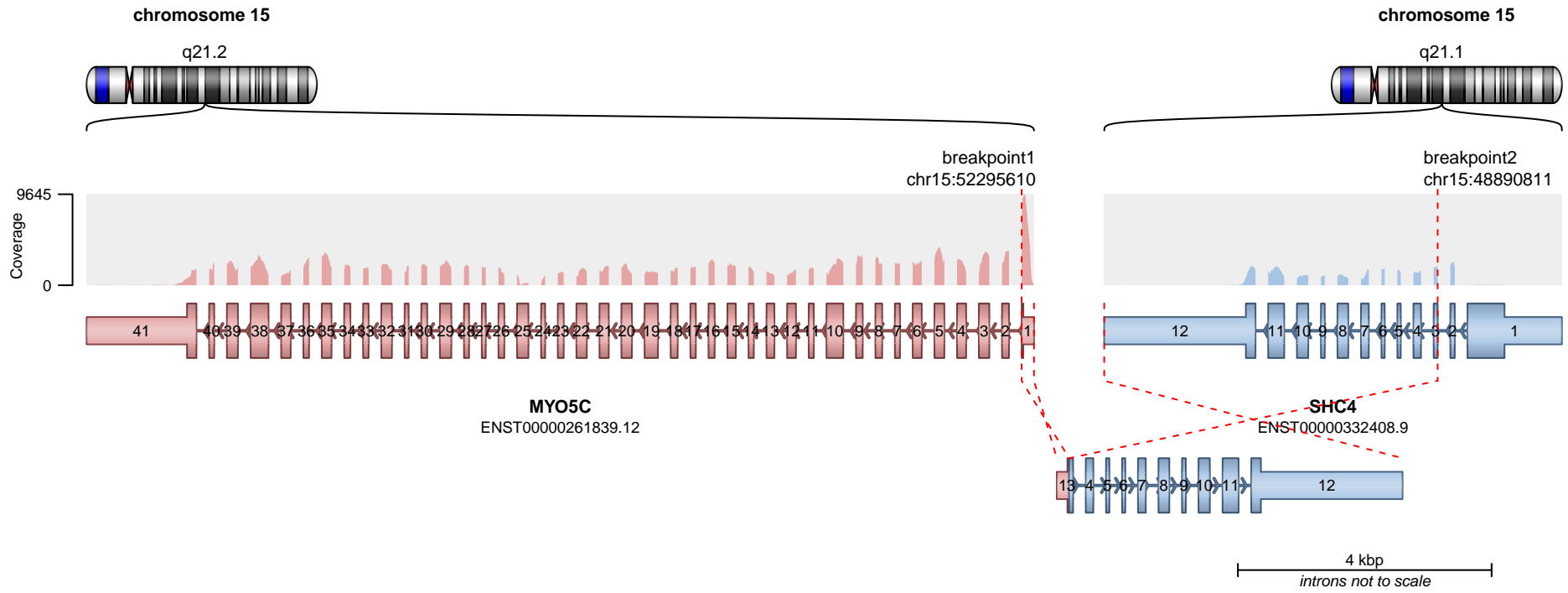

**RETAINED PROTEIN DOMAINS**  
reading frame unclear

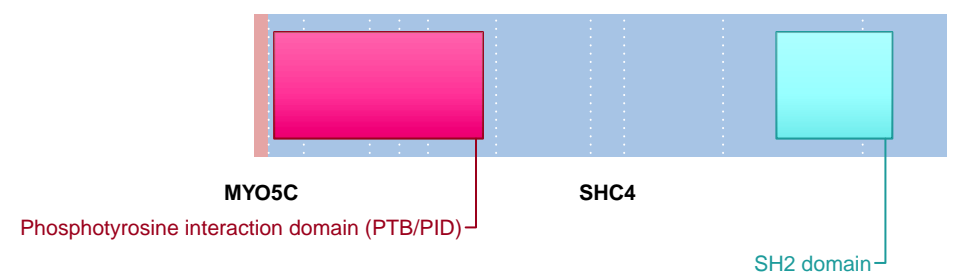

**SUPPORTING READ COUNT**

Split reads = 32  
Discordant mates = 6

- translocation
- duplication
- deletion
- inversion

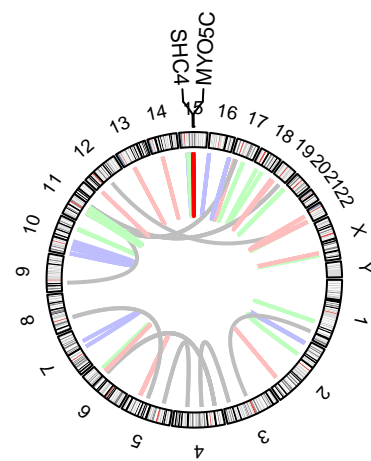
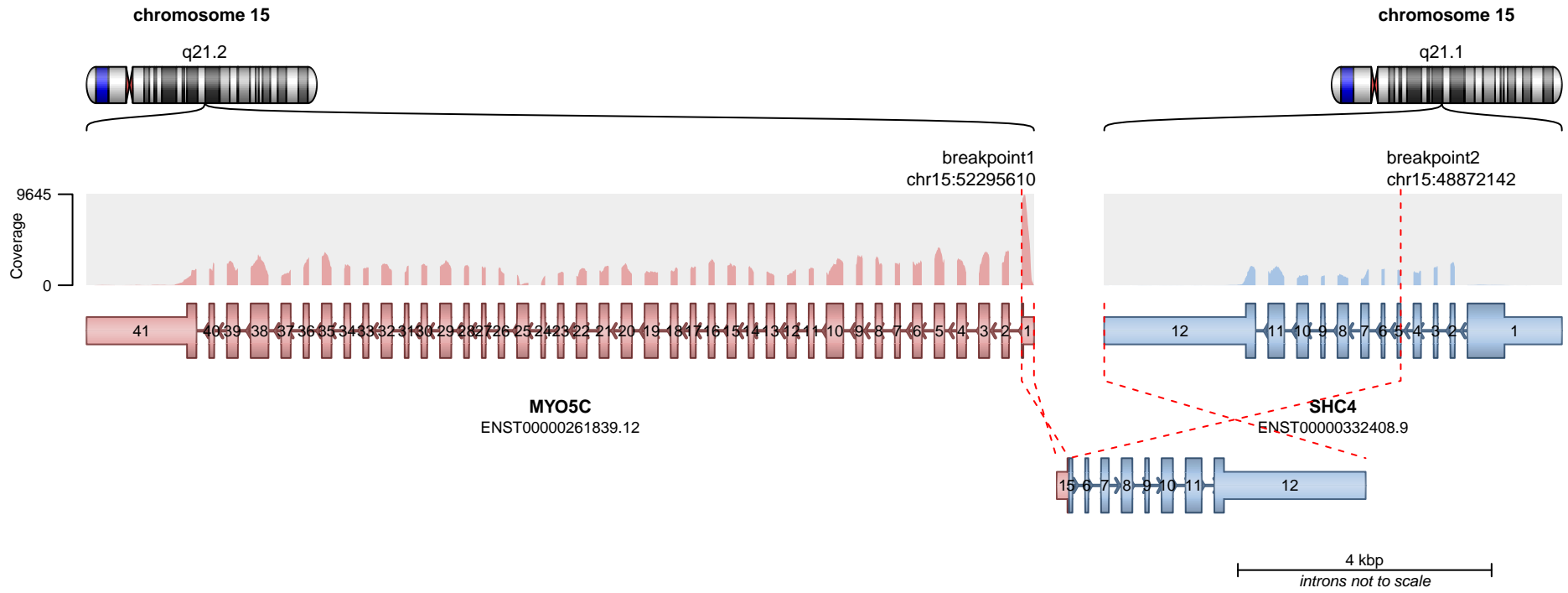

**RETAINED PROTEIN DOMAINS**  
reading frame unclear

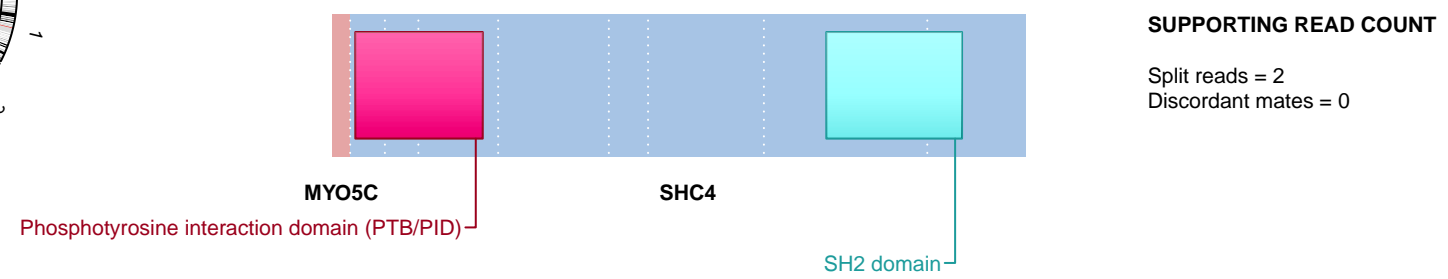

- translocation
- duplication
- deletion
- inversion

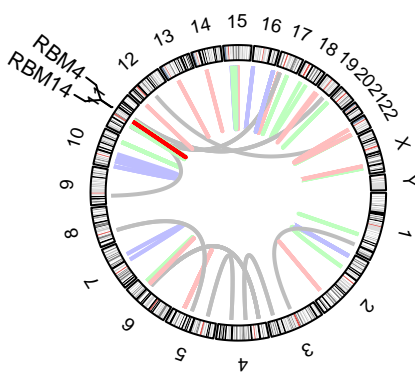
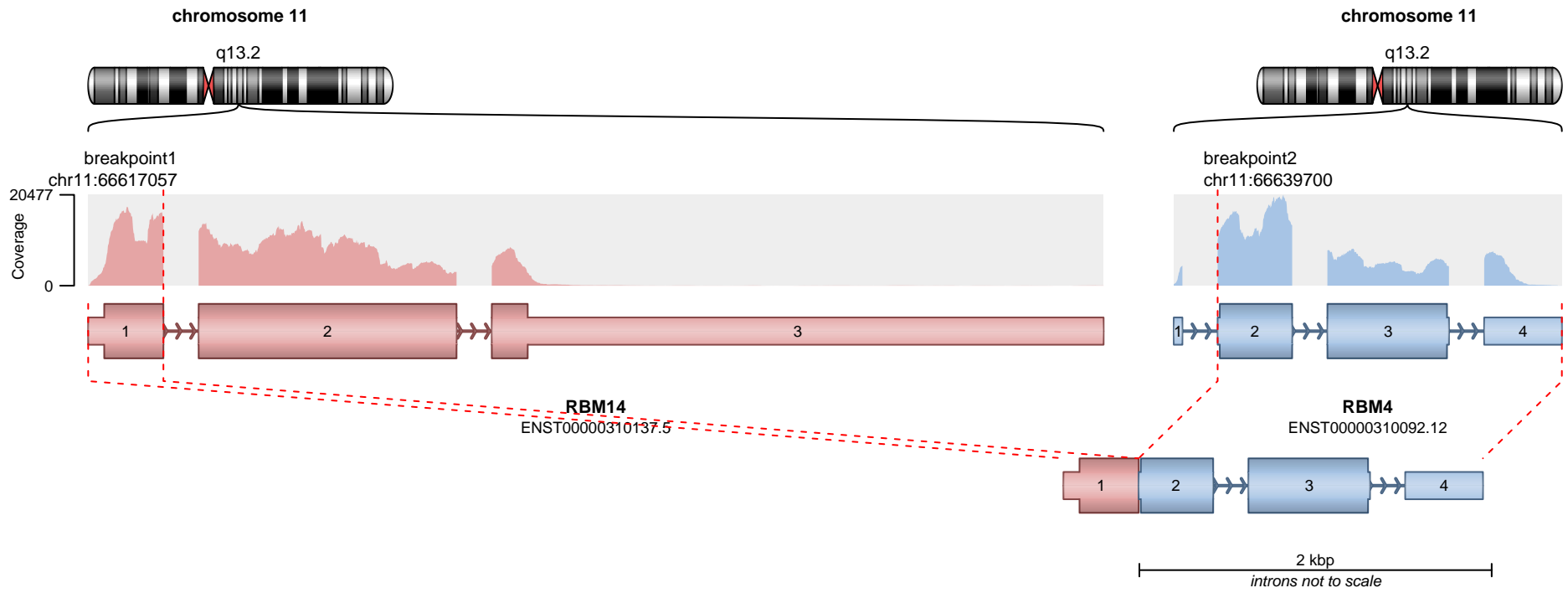

**RETAINED PROTEIN DOMAINS**  
reading frame unclear

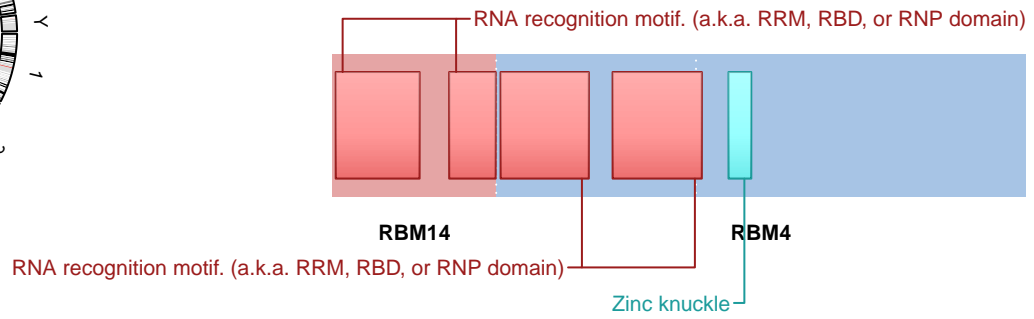

**SUPPORTING READ COUNT**

Split reads = 904  
Discordant mates = 16

- translocation
- duplication
- deletion
- inversion

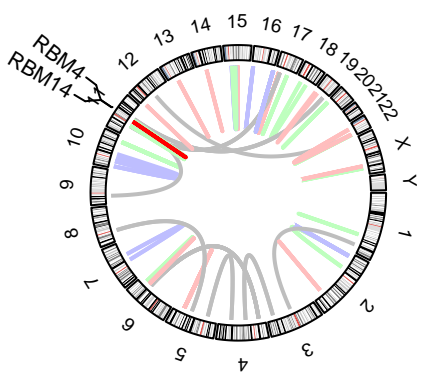
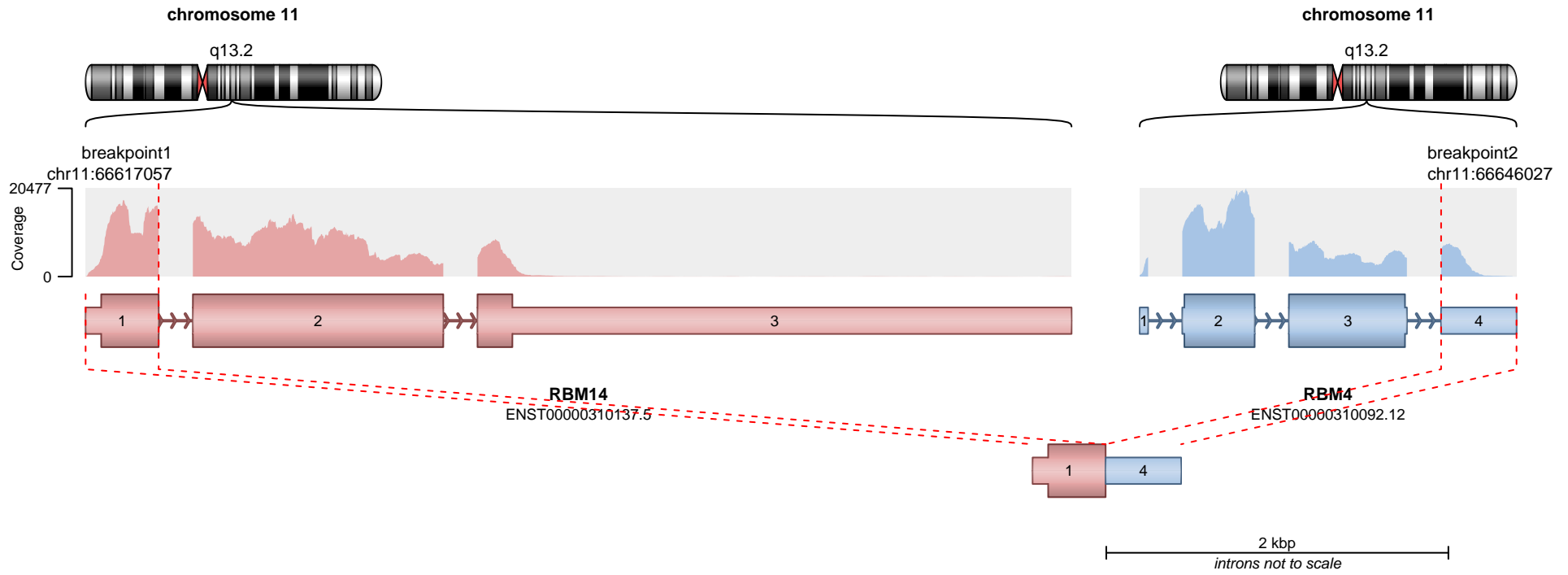

**RETAINED PROTEIN DOMAINS**  
reading frame unclear

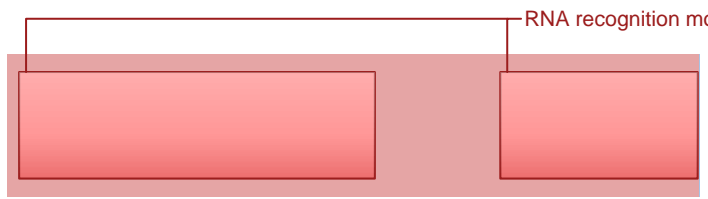

**SUPPORTING READ COUNT**

Split reads = 106  
Discordant mates = 0

- translocation
- duplication
- deletion
- inversion

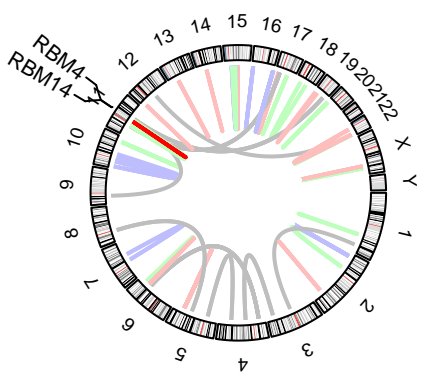
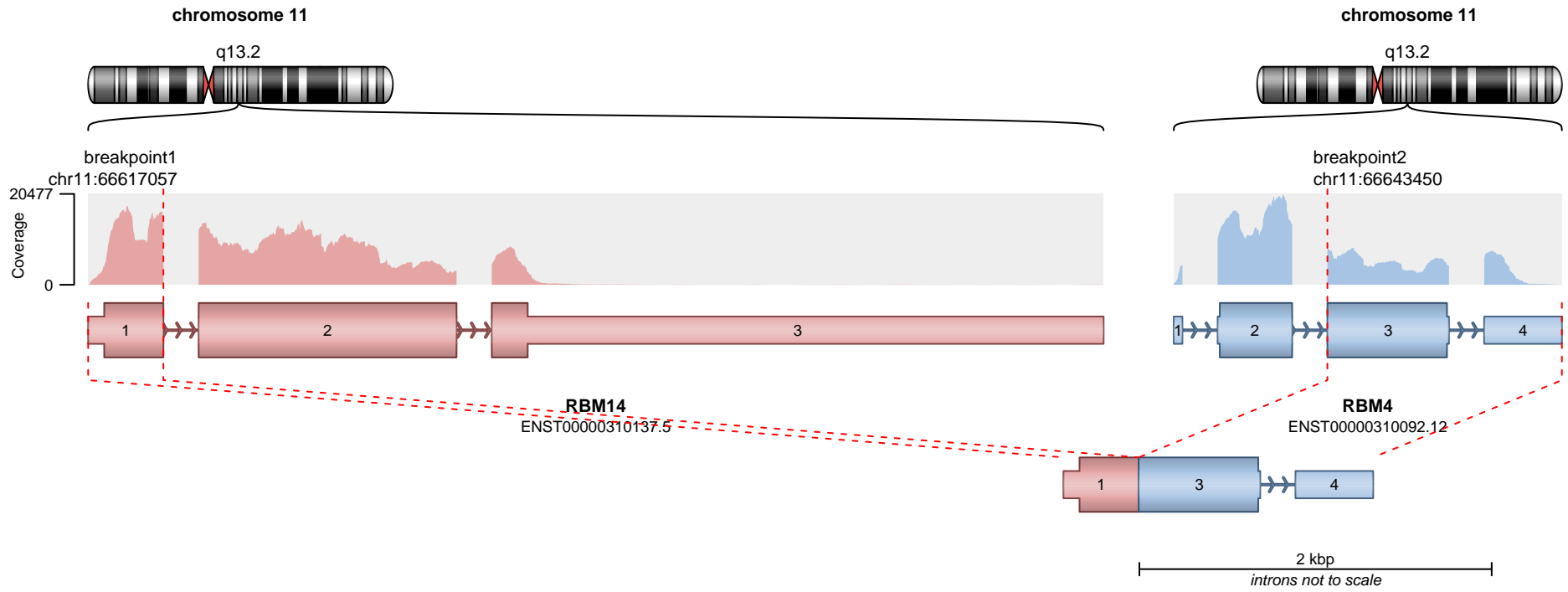

**RETAINED PROTEIN DOMAINS**  
reading frame unclear

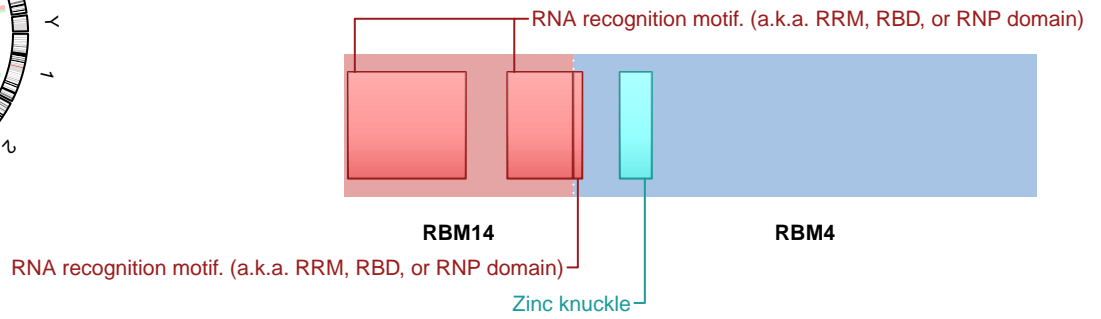

**SUPPORTING READ COUNT**

Split reads = 26  
Discordant mates = 0

- translocation
- duplication
- deletion
- inversion

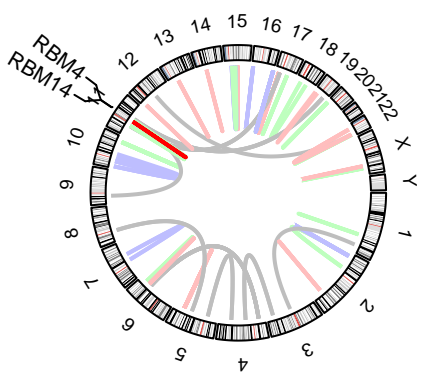
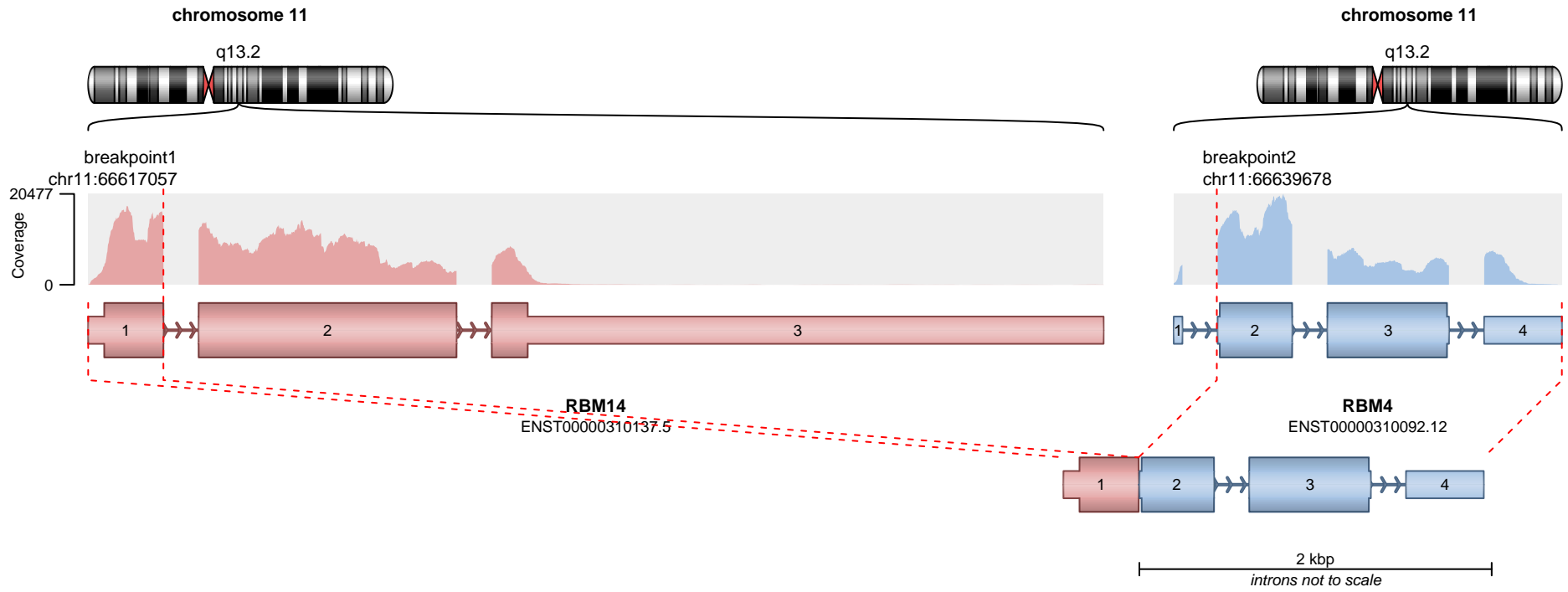

**RETAINED PROTEIN DOMAINS**  
reading frame unclear

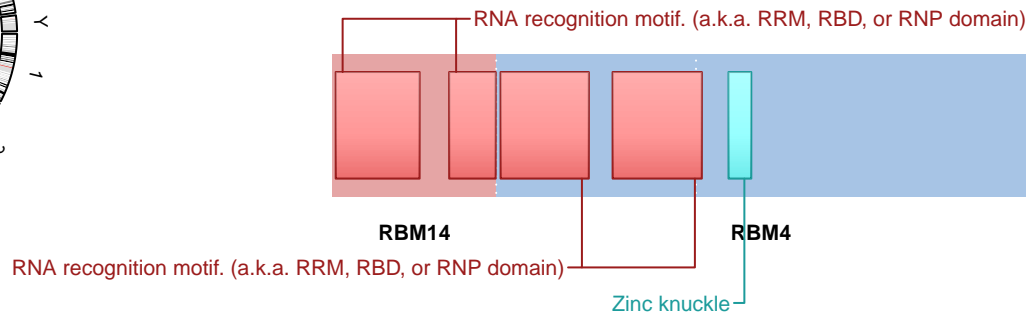

**SUPPORTING READ COUNT**

Split reads = 21  
Discordant mates = 16

- translocation
- duplication
- deletion
- inversion

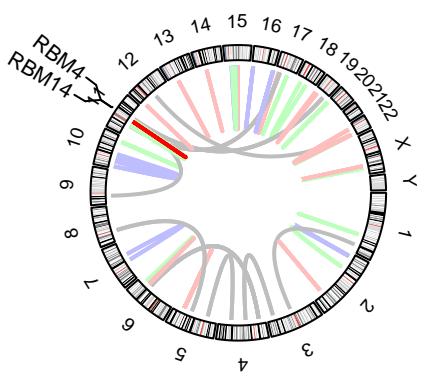
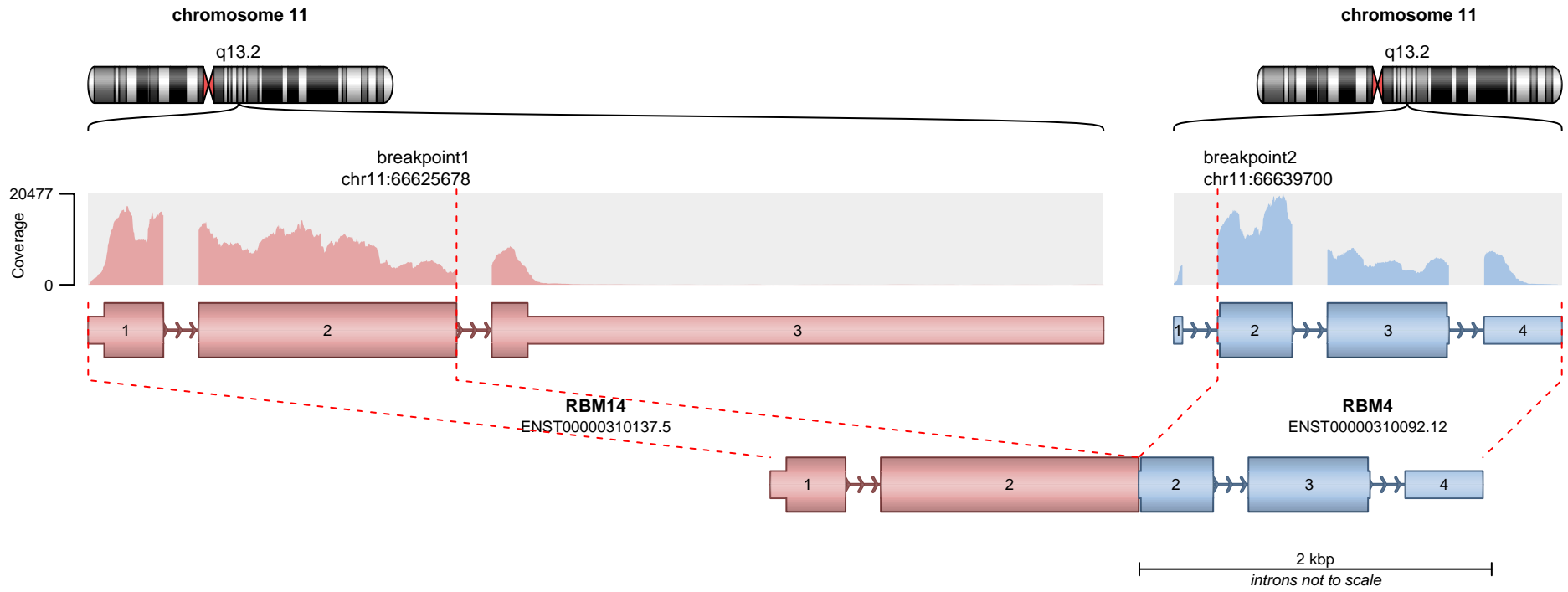

**RETAINED PROTEIN DOMAINS**  
reading frame unclear

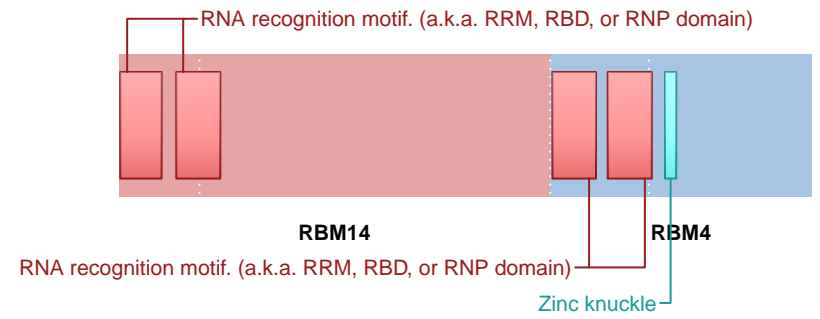

**SUPPORTING READ COUNT**

Split reads = 10  
Discordant mates = 16

- translocation
- duplication
- deletion
- inversion

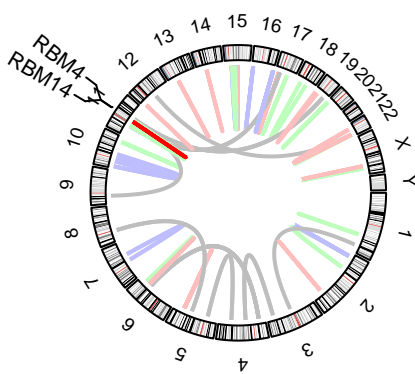
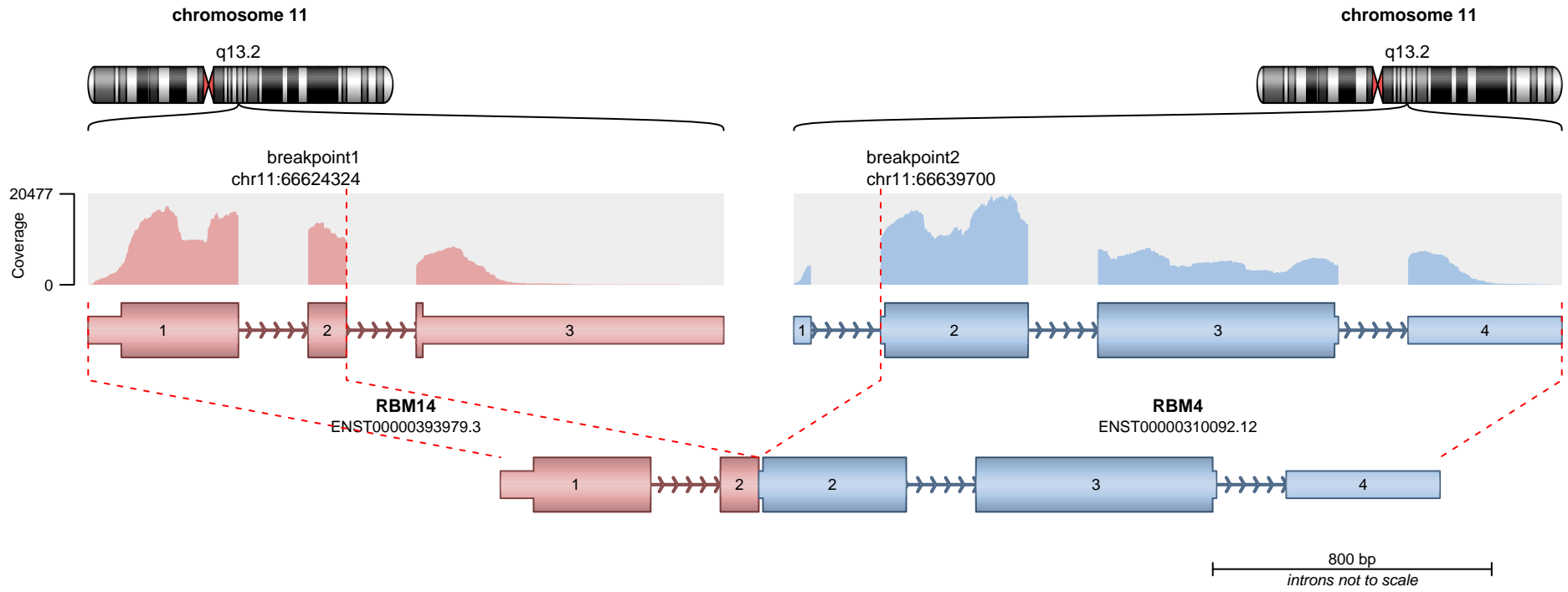

**RETAINED PROTEIN DOMAINS**  
reading frame unclear

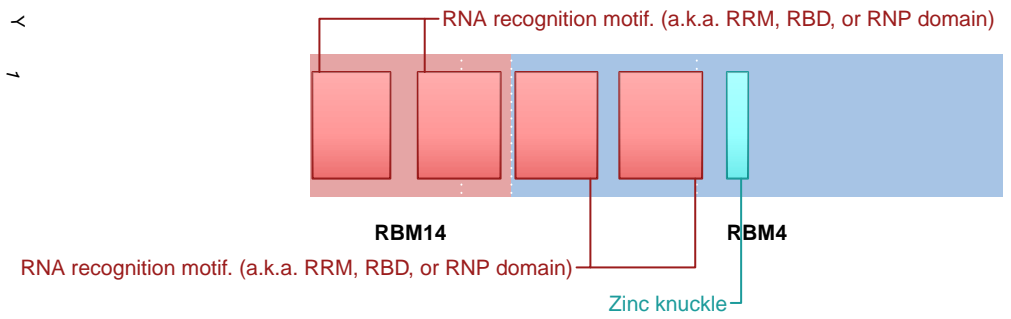

**SUPPORTING READ COUNT**

Split reads = 3  
Discordant mates = 16

- translocation
- duplication
- deletion
- inversion

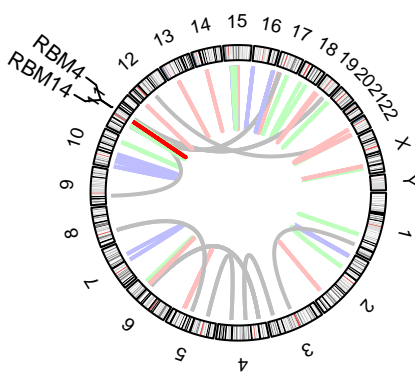
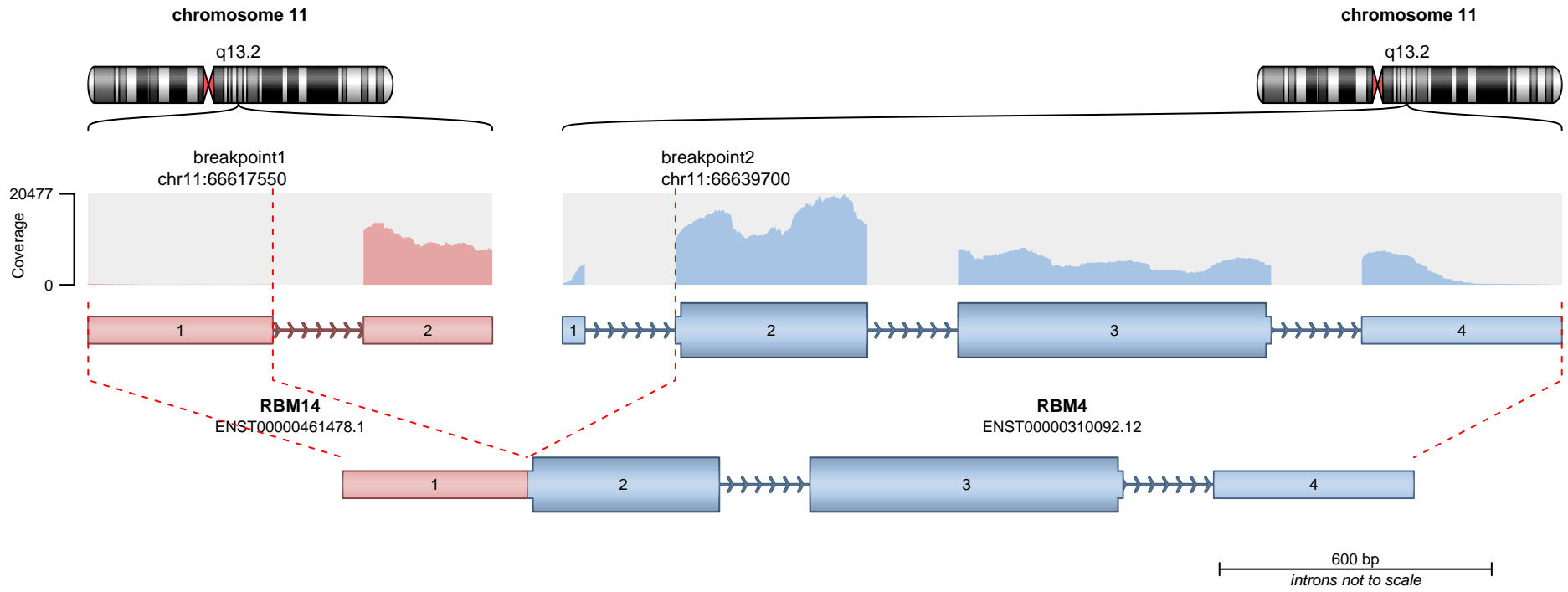

RNA recognition motif. (a.k.a. RRM, RBD, or RNP domain)

**RETAINED PROTEIN DOMAINS**  
reading frame unclear

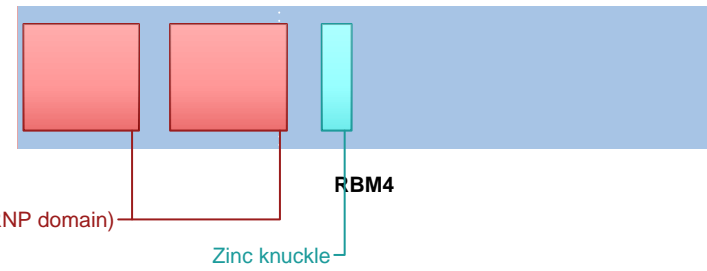

**SUPPORTING READ COUNT**

Split reads = 2  
Discordant mates = 16

- translocation
- duplication
- deletion
- inversion

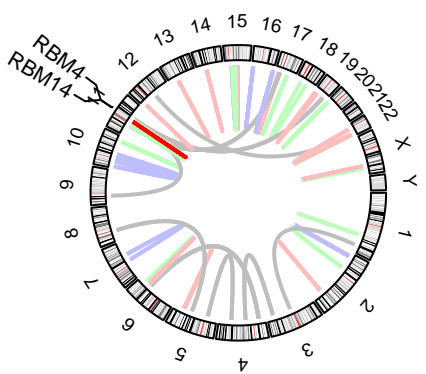
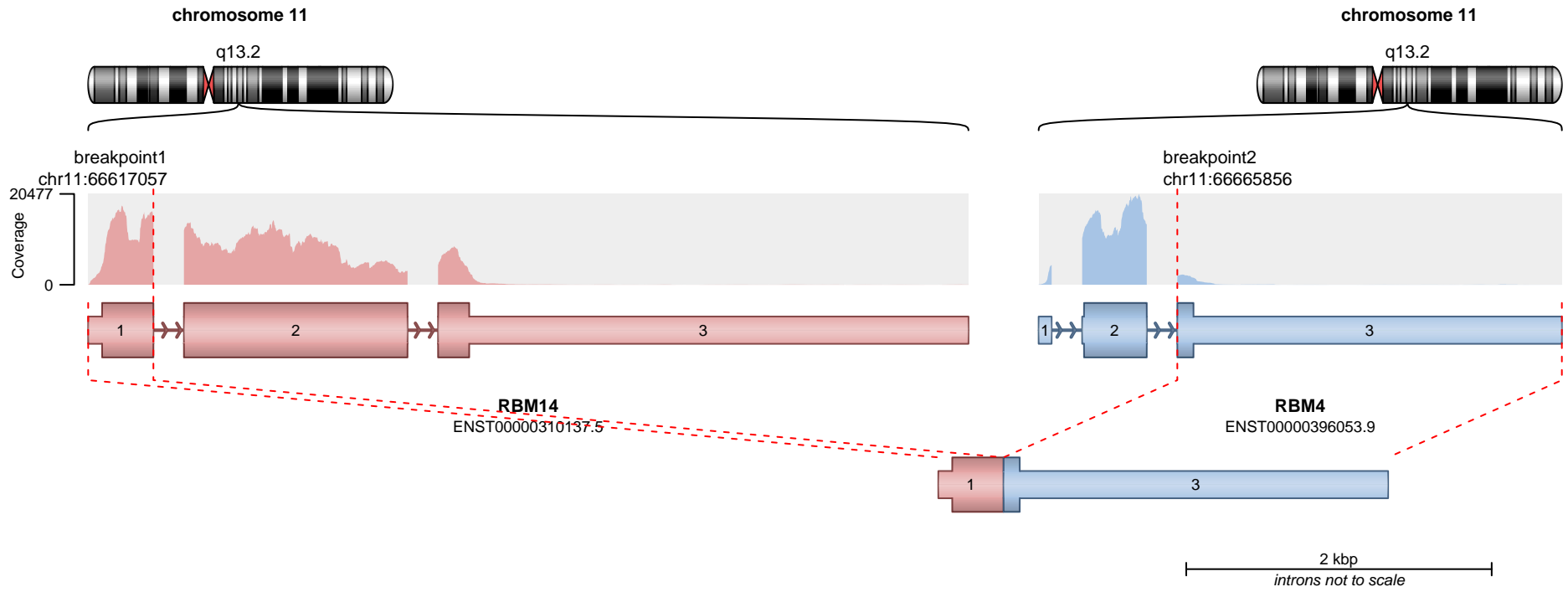

**RETAINED PROTEIN DOMAINS**  
reading frame unclear

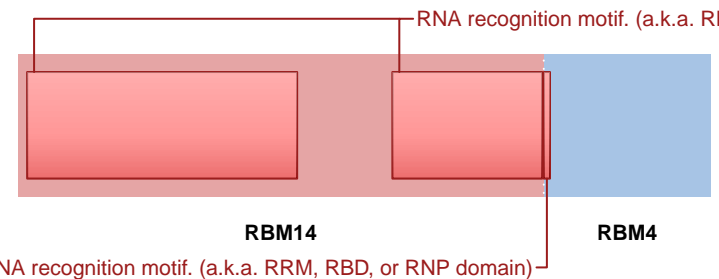

**SUPPORTING READ COUNT**

Split reads = 2  
Discordant mates = 0

- translocation
- duplication
- deletion
- inversion

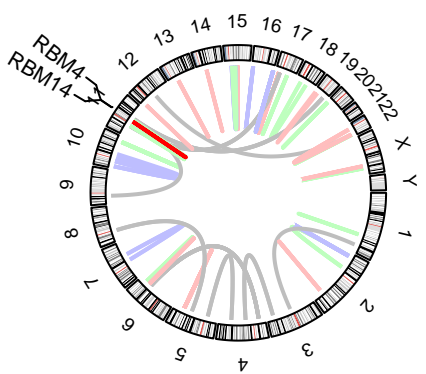
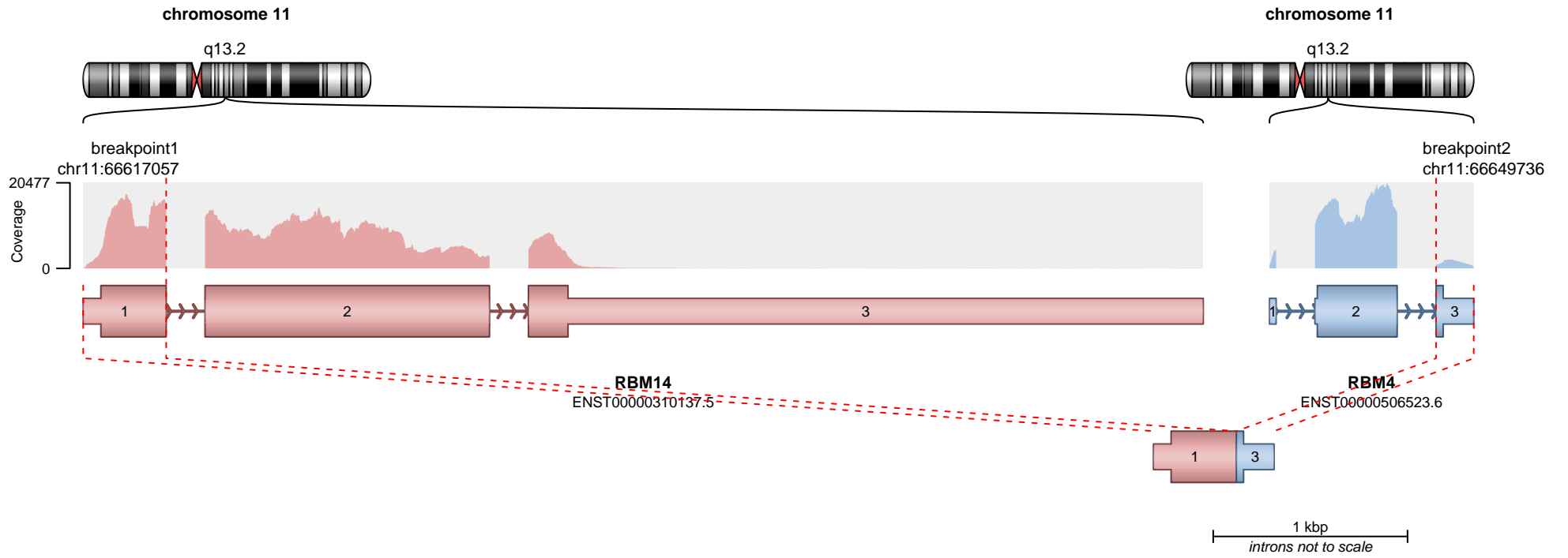

— translocation    — deletion  
 — duplication    — inversion

**RETAINED PROTEIN DOMAINS**  
reading frame unclear

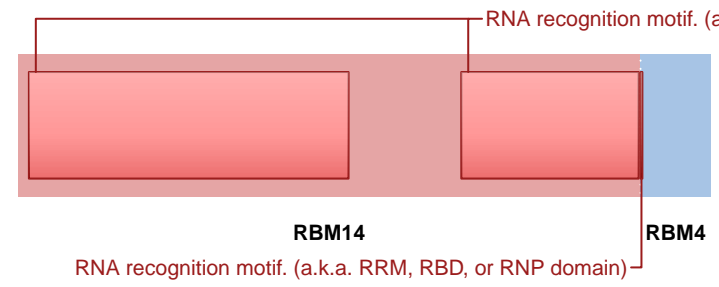

**SUPPORTING READ COUNT**

Split reads = 1  
 Discordant mates = 0

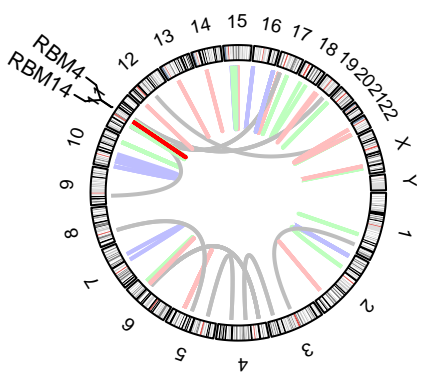
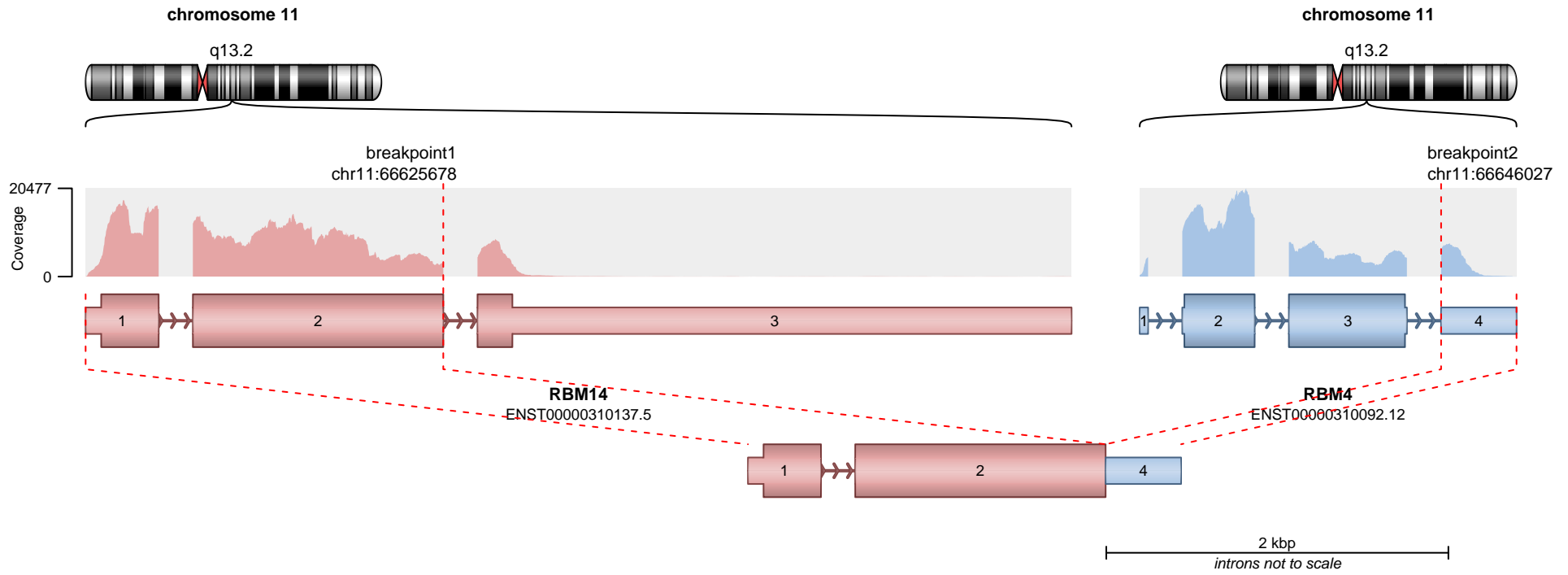

**RETAINED PROTEIN DOMAINS**  
reading frame unclear

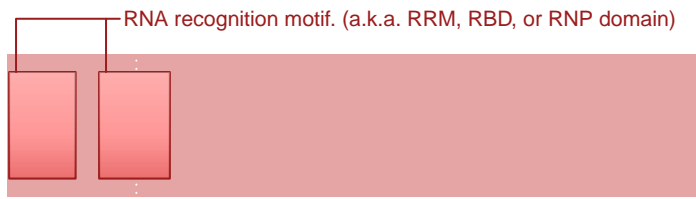

**RBM14**

**SUPPORTING READ COUNT**

Split reads = 1  
Discordant mates = 0

- translocation
- duplication
- deletion
- inversion

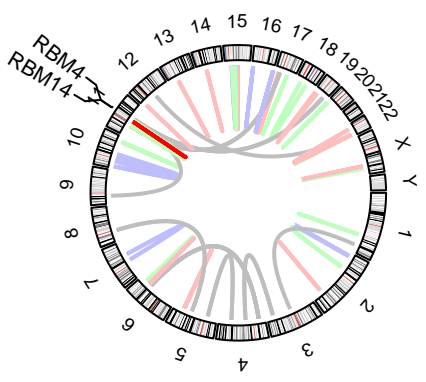
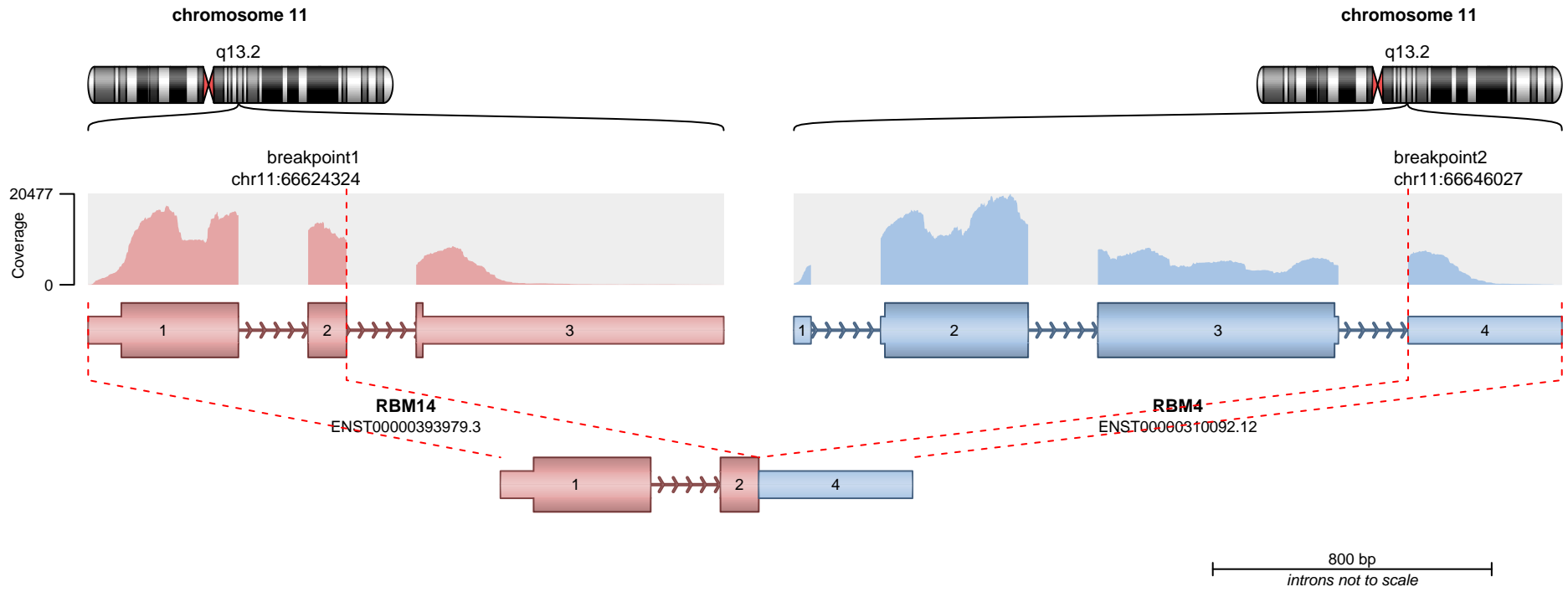

RETAINED PROTEIN DOMAINS  
reading frame unclear

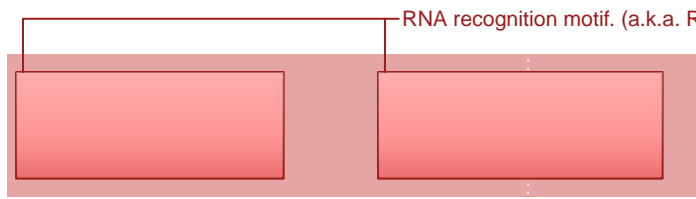

RBM14

SUPPORTING READ COUNT

Split reads = 1  
Discordant mates = 0

— translocation — deletion  
— duplication — inversion

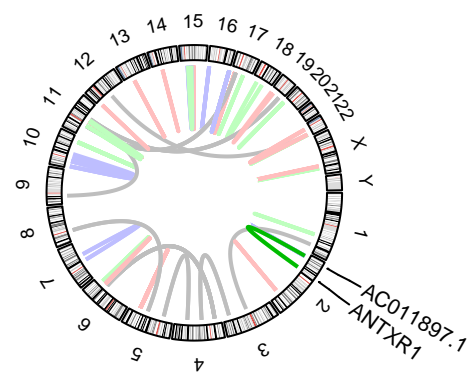
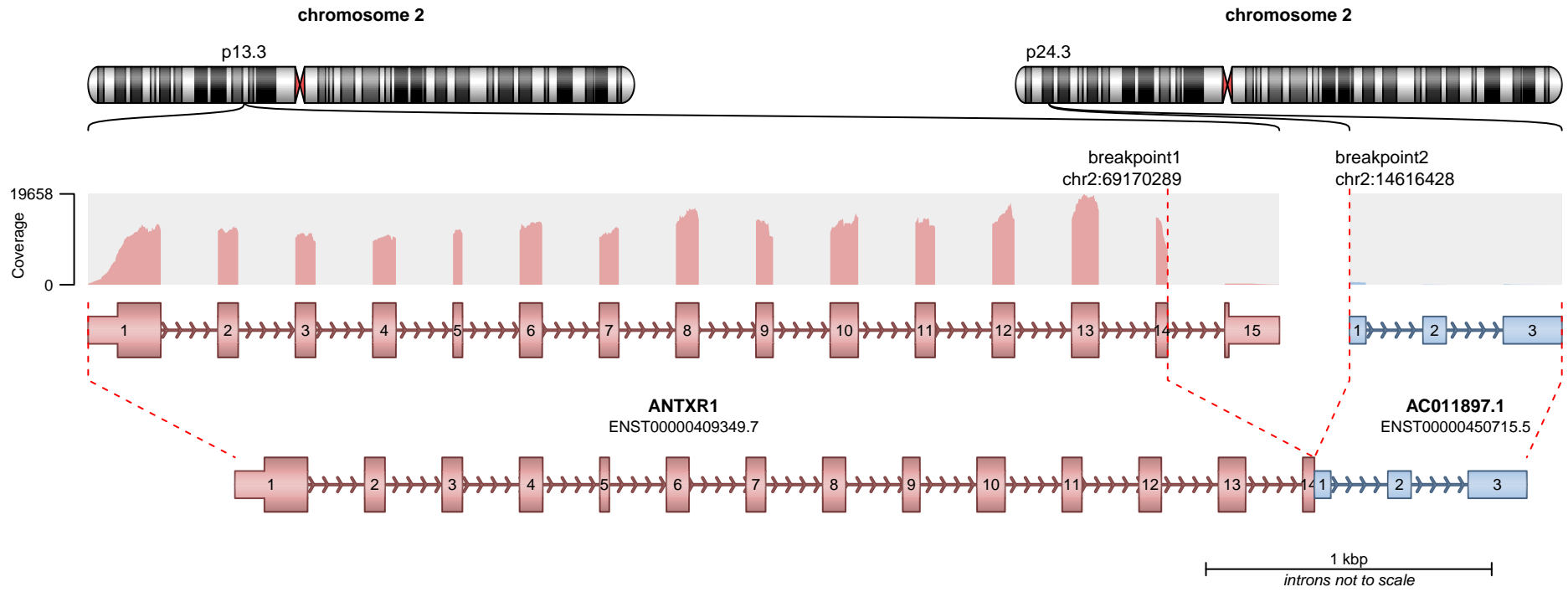

**RETAINED PROTEIN DOMAINS**  
reading frame unclear

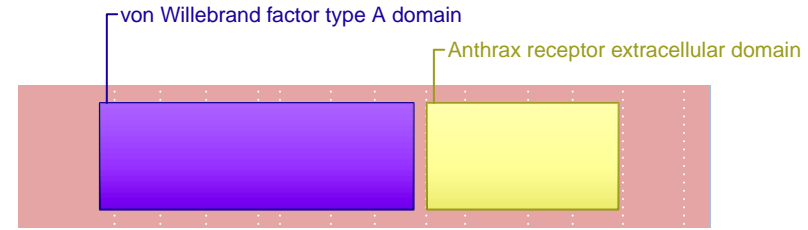

**ANTXR1**

**SUPPORTING READ COUNT**

Split reads = 587  
Discordant mates = 6

- translocation
- duplication
- deletion
- inversion

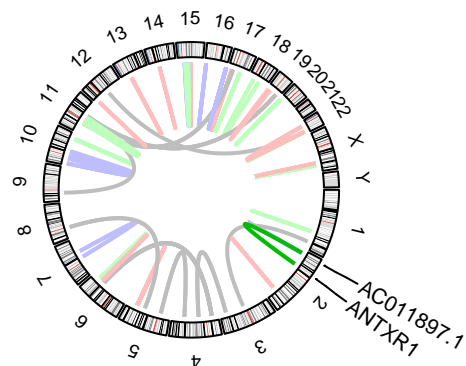
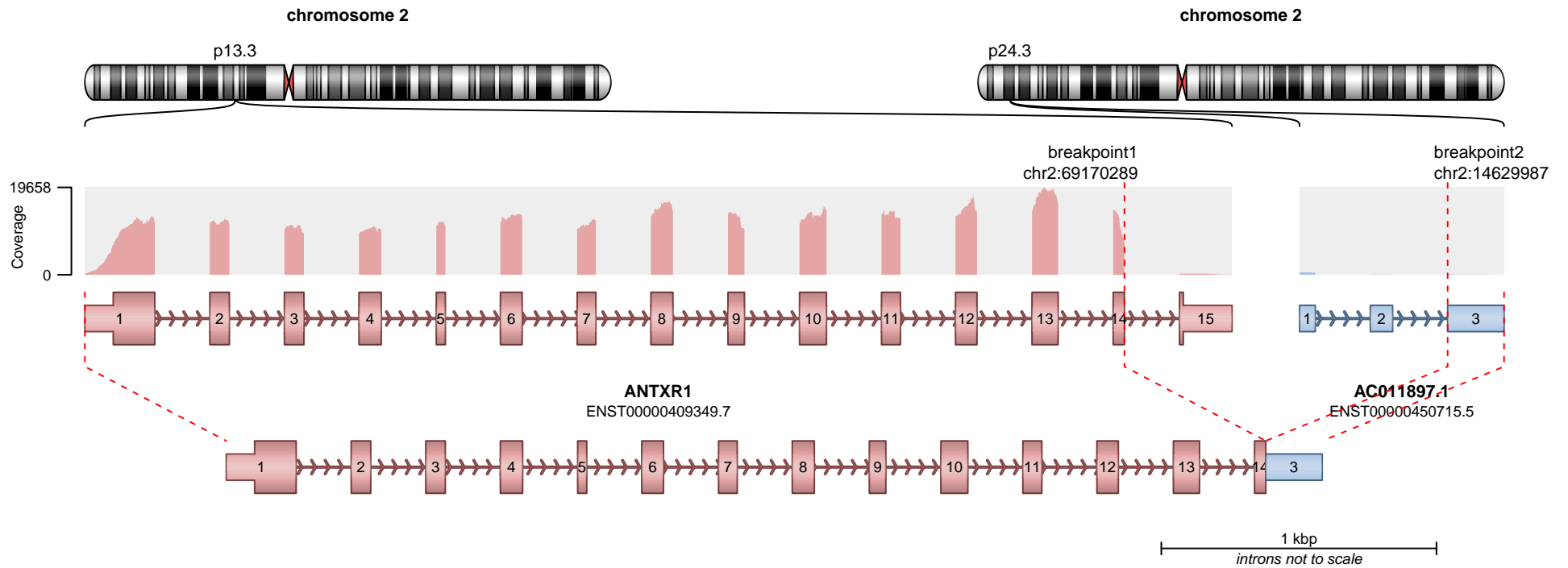

**RETAINED PROTEIN DOMAINS**  
reading frame unclear

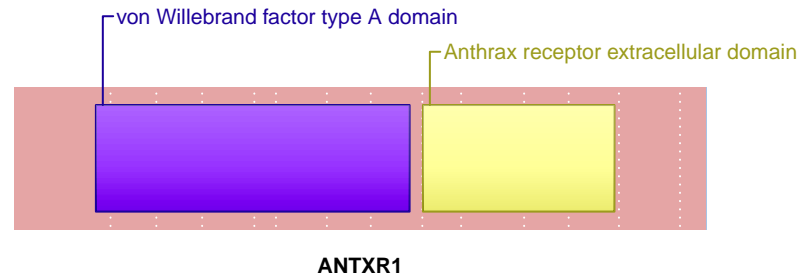

**SUPPORTING READ COUNT**

Split reads = 2  
Discordant mates = 2

— translocation — deletion  
— duplication — inversion

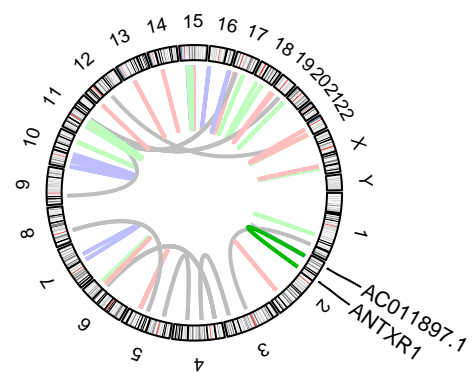
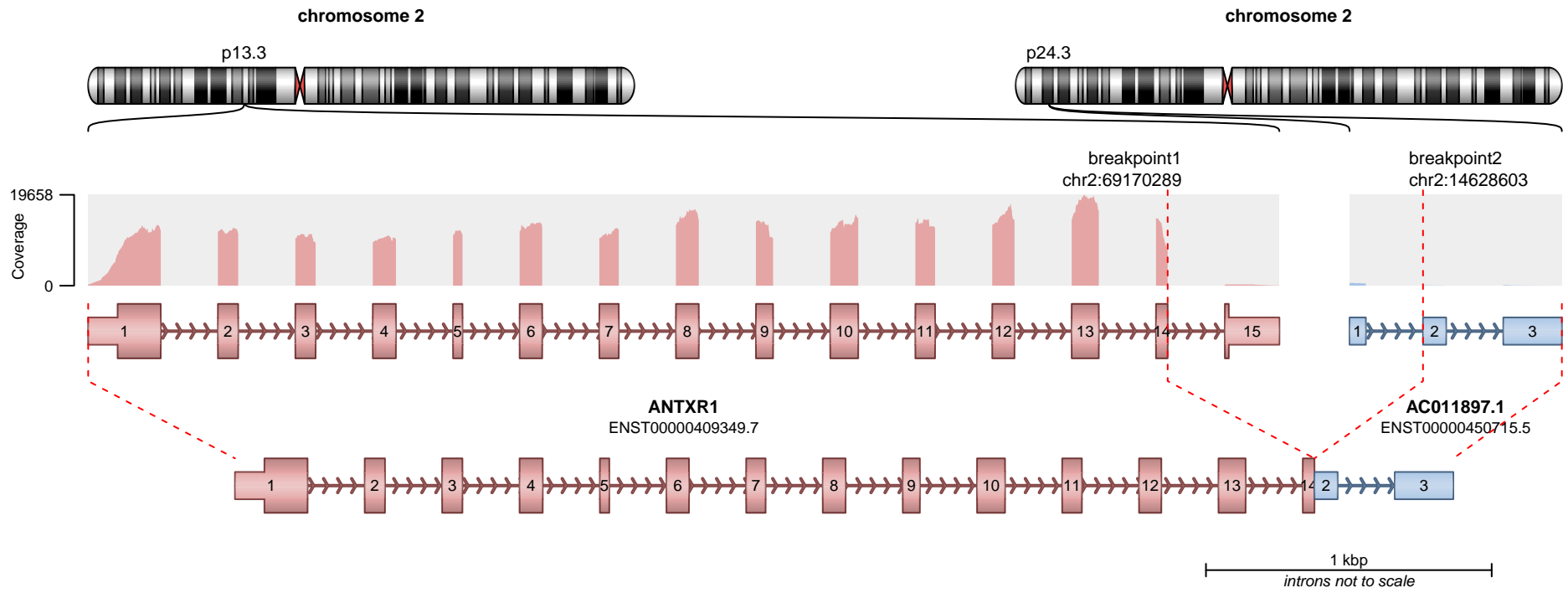

**RETAINED PROTEIN DOMAINS**  
reading frame unclear

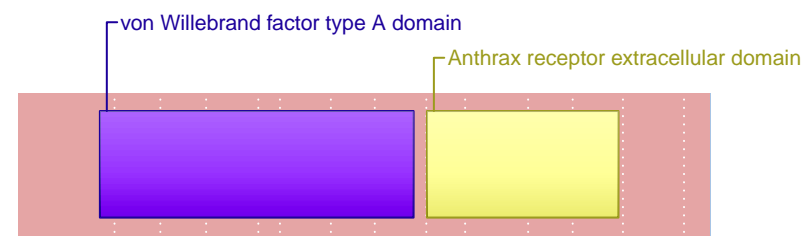

**SUPPORTING READ COUNT**

Split reads = 1  
Discordant mates = 2

- translocation
- duplication
- deletion
- inversion

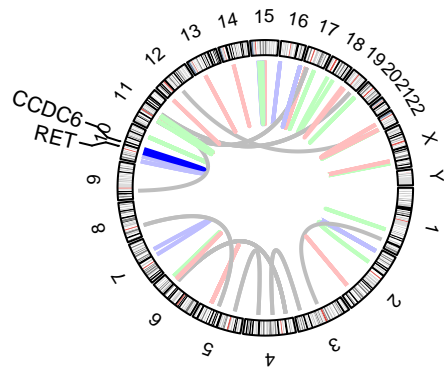
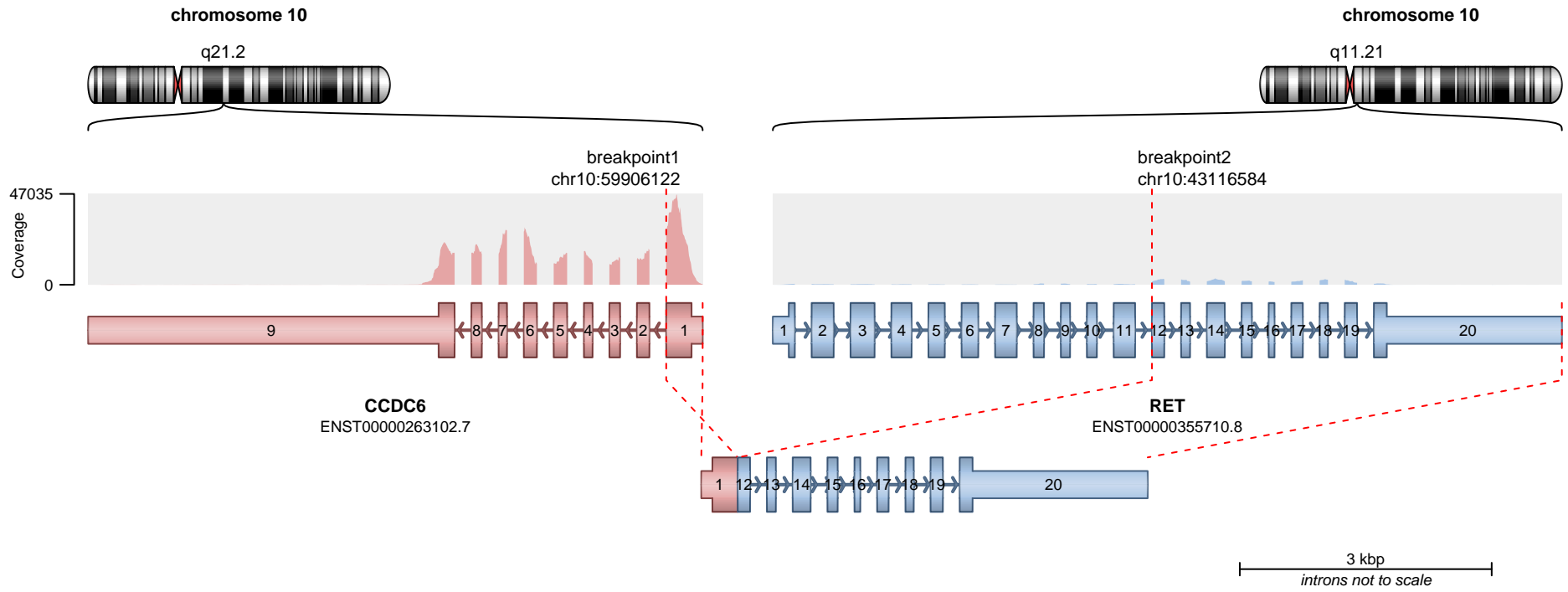

**RETAINED PROTEIN DOMAINS**  
reading frame unclear

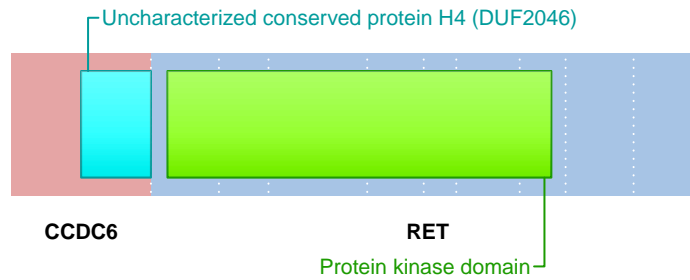

**SUPPORTING READ COUNT**

Split reads = 384  
Discordant mates = 8

- translocation
- duplication
- deletion
- inversion

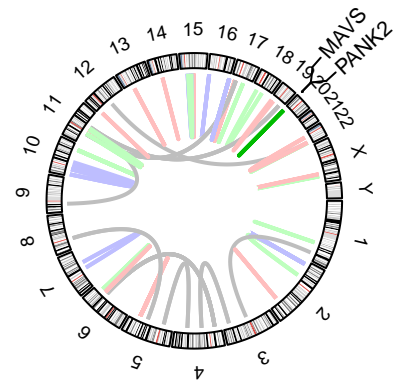
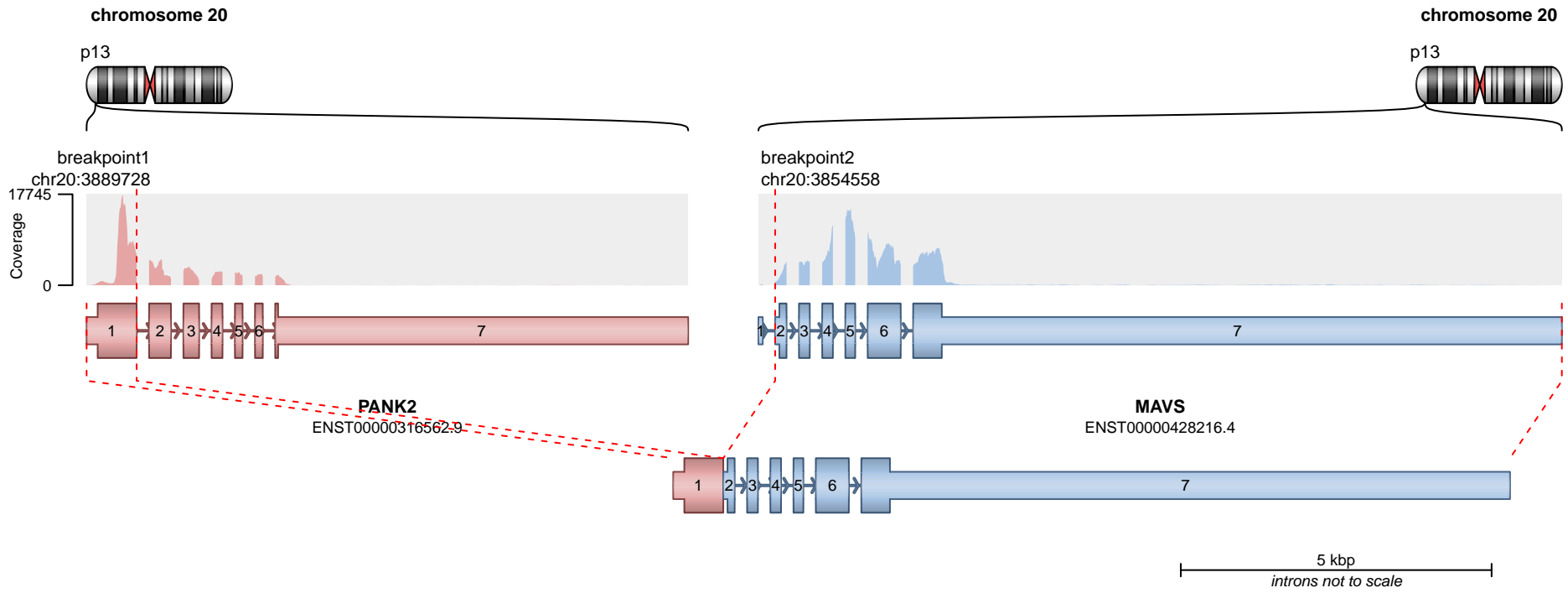

**RETAINED PROTEIN DOMAINS**  
reading frame unclear

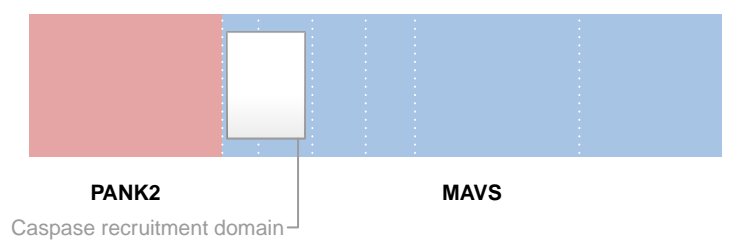

**SUPPORTING READ COUNT**

Split reads = 204  
Discordant mates = 2

- translocation
- duplication
- deletion
- inversion

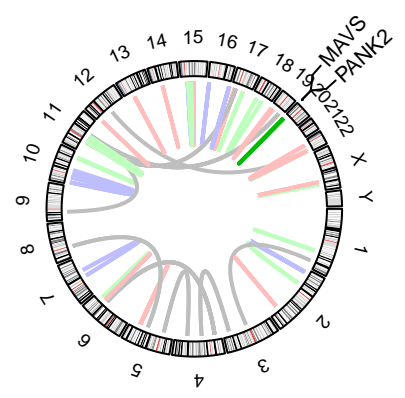
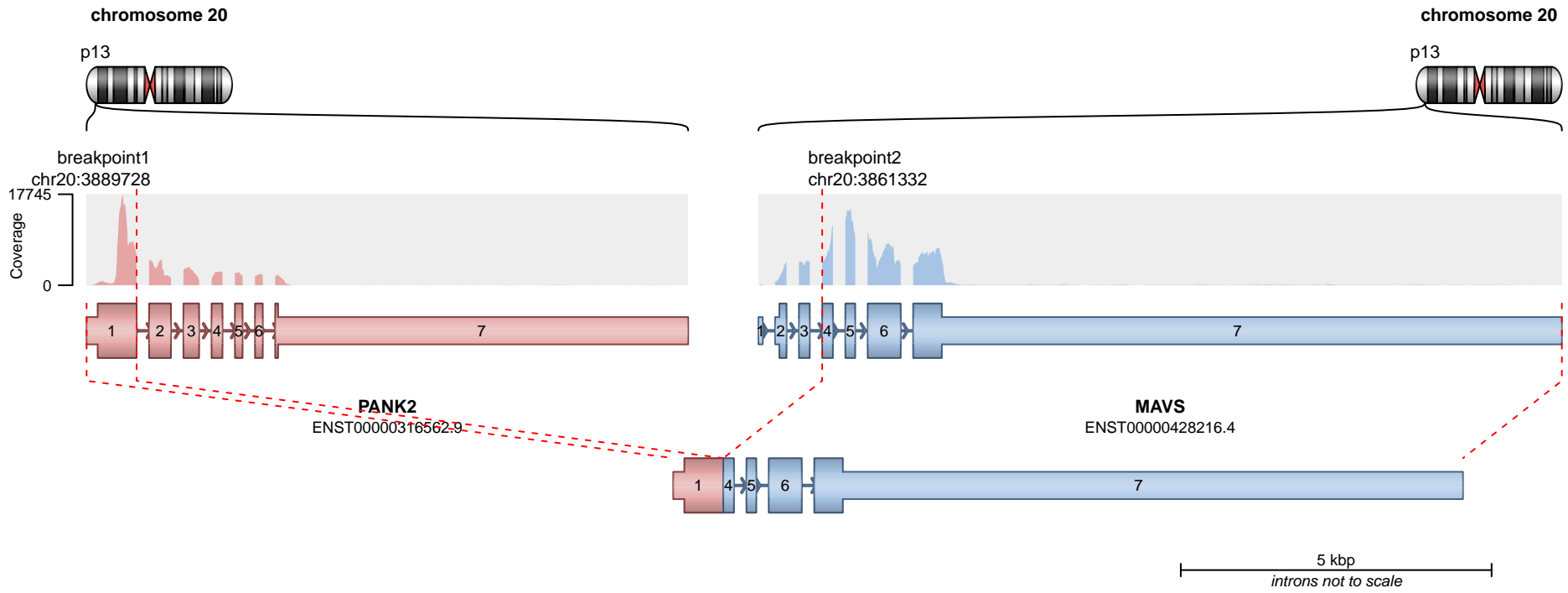

— translocation    — deletion  
— duplication    — inversion

No protein domains retained in fusion.

**SUPPORTING READ COUNT**

Split reads = 3  
Discordant mates = 0

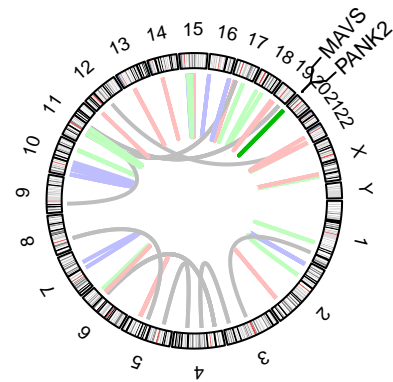
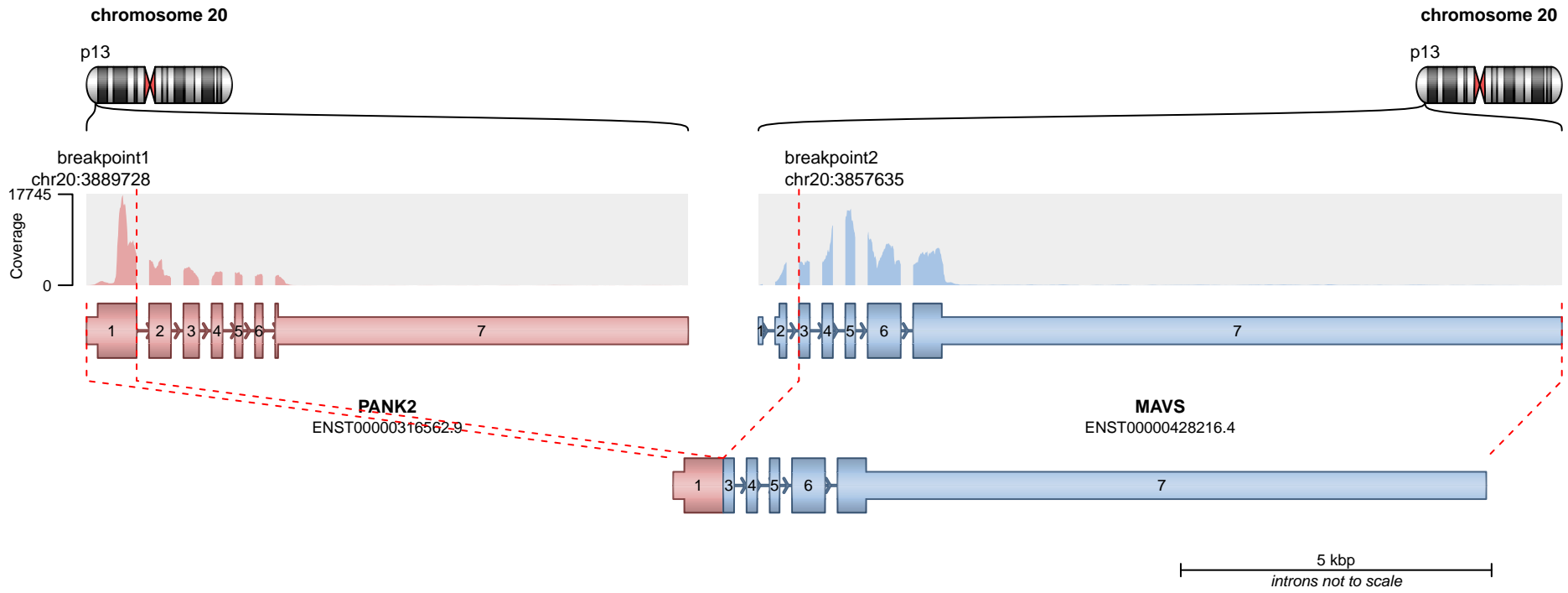

**RETAINED PROTEIN DOMAINS**  
reading frame unclear

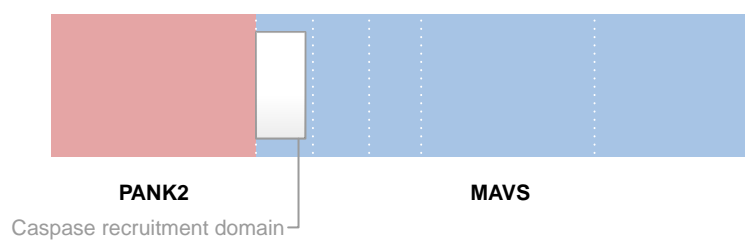

**SUPPORTING READ COUNT**

Split reads = 2  
Discordant mates = 0

- translocation
- duplication
- deletion
- inversion

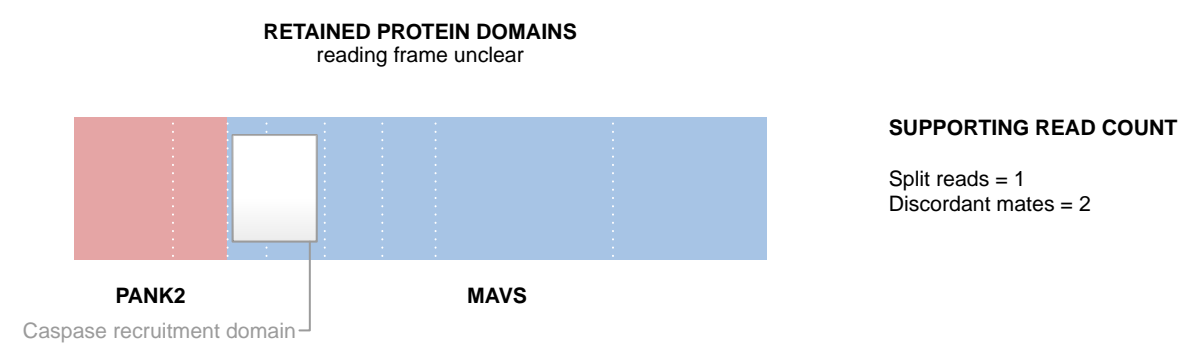
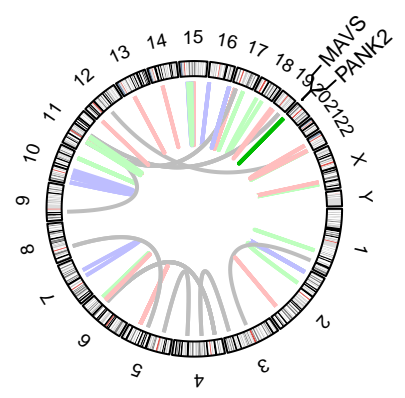
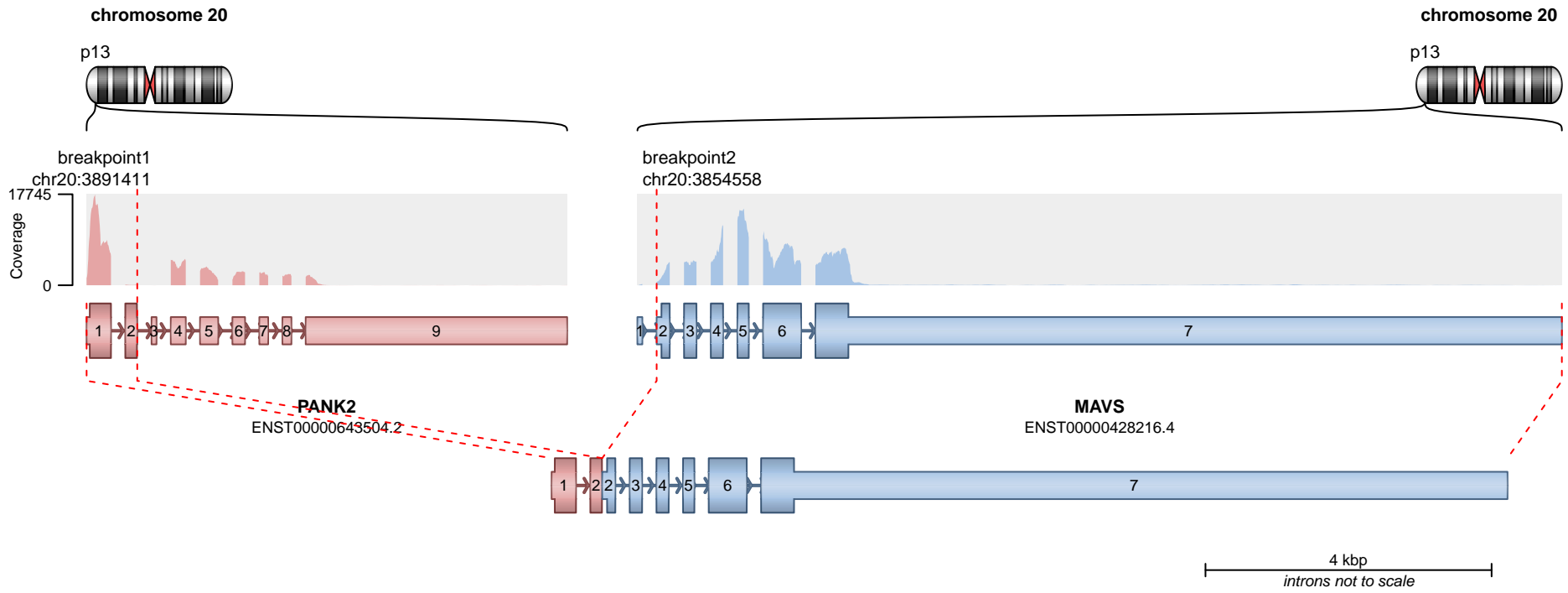

— translocation — deletion  
— duplication — inversion

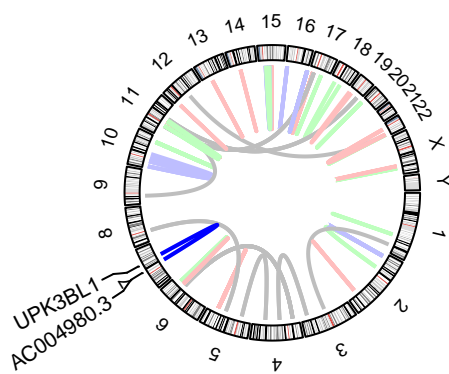
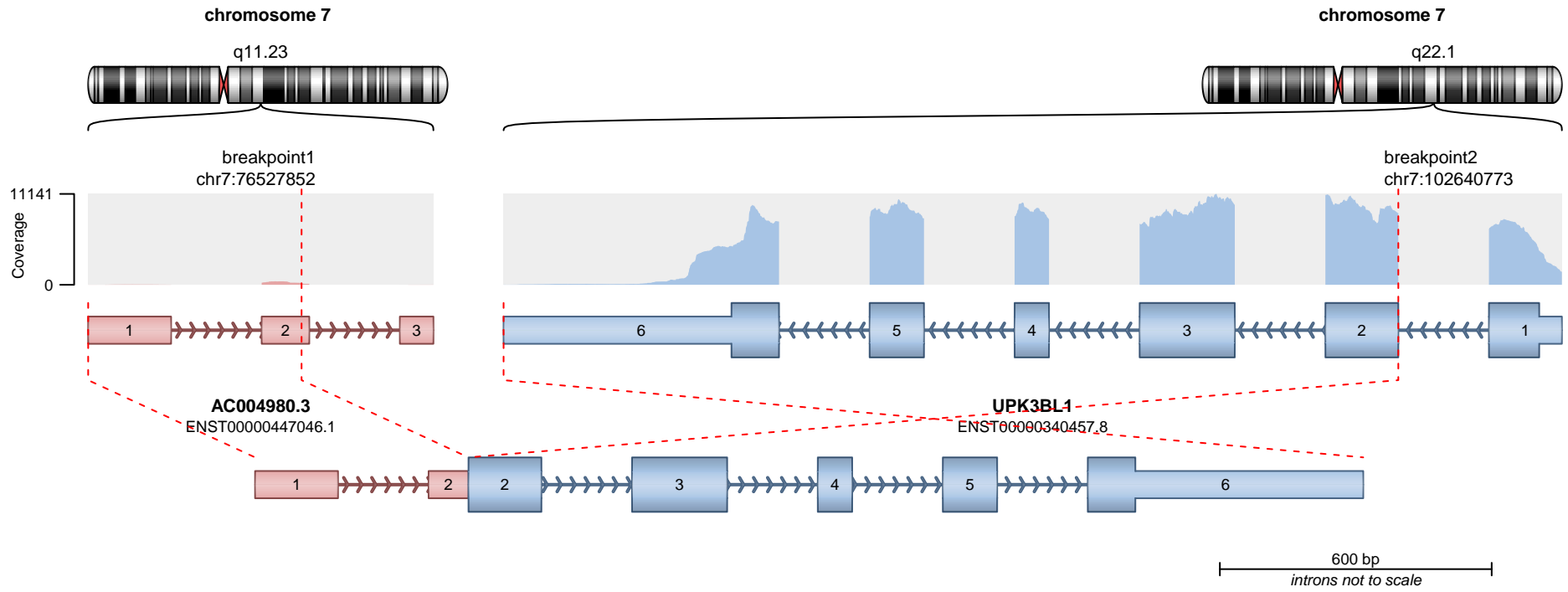

— translocation — deletion  
— duplication — inversion

No protein domains retained in fusion.

**SUPPORTING READ COUNT**

Split reads = 154  
Discordant mates = 0

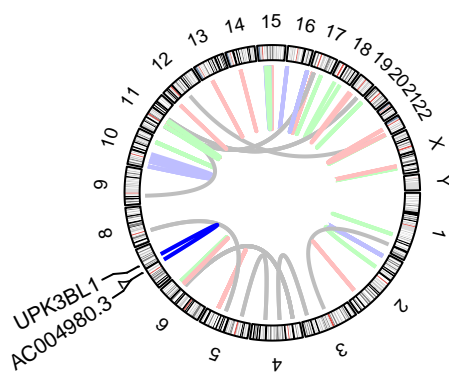
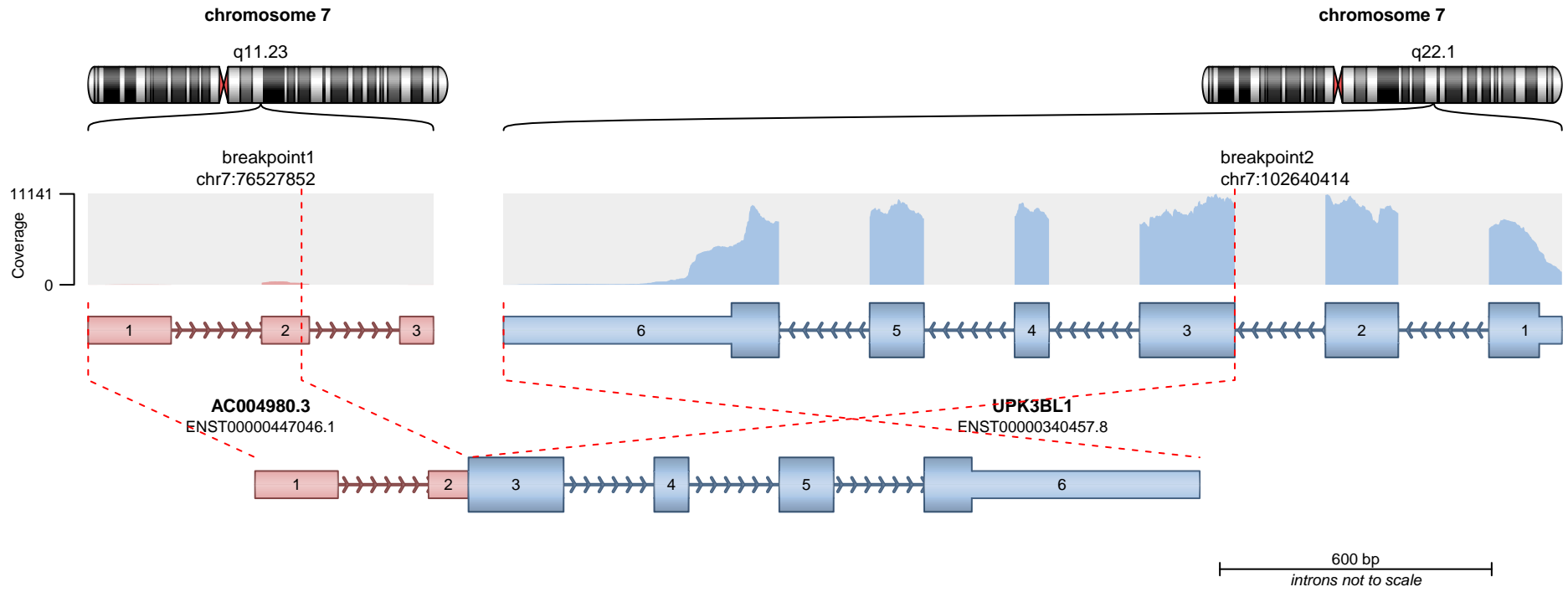

— translocation — deletion  
— duplication — inversion

No protein domains retained in fusion.

**SUPPORTING READ COUNT**

Split reads = 5  
Discordant mates = 0

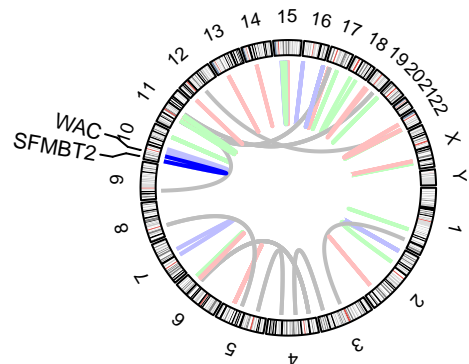
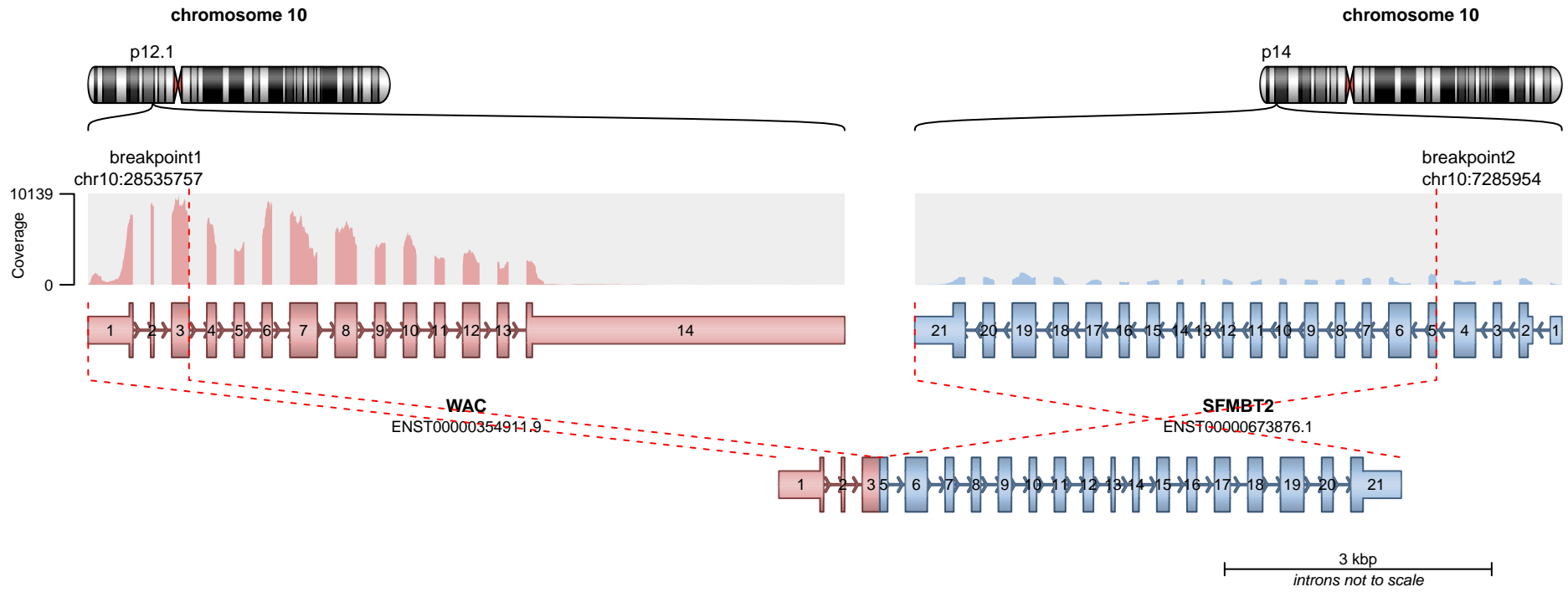

— translocation — deletion  
— duplication — inversion

**RETAINED PROTEIN DOMAINS**  
reading frame unclear

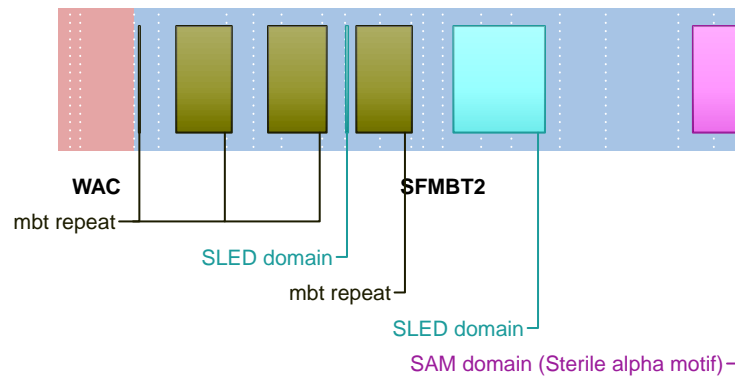

**SUPPORTING READ COUNT**

Split reads = 141  
Discordant mates = 2

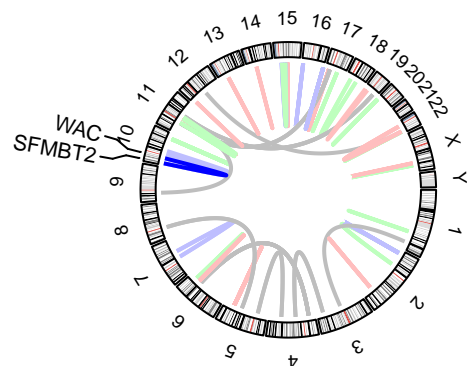
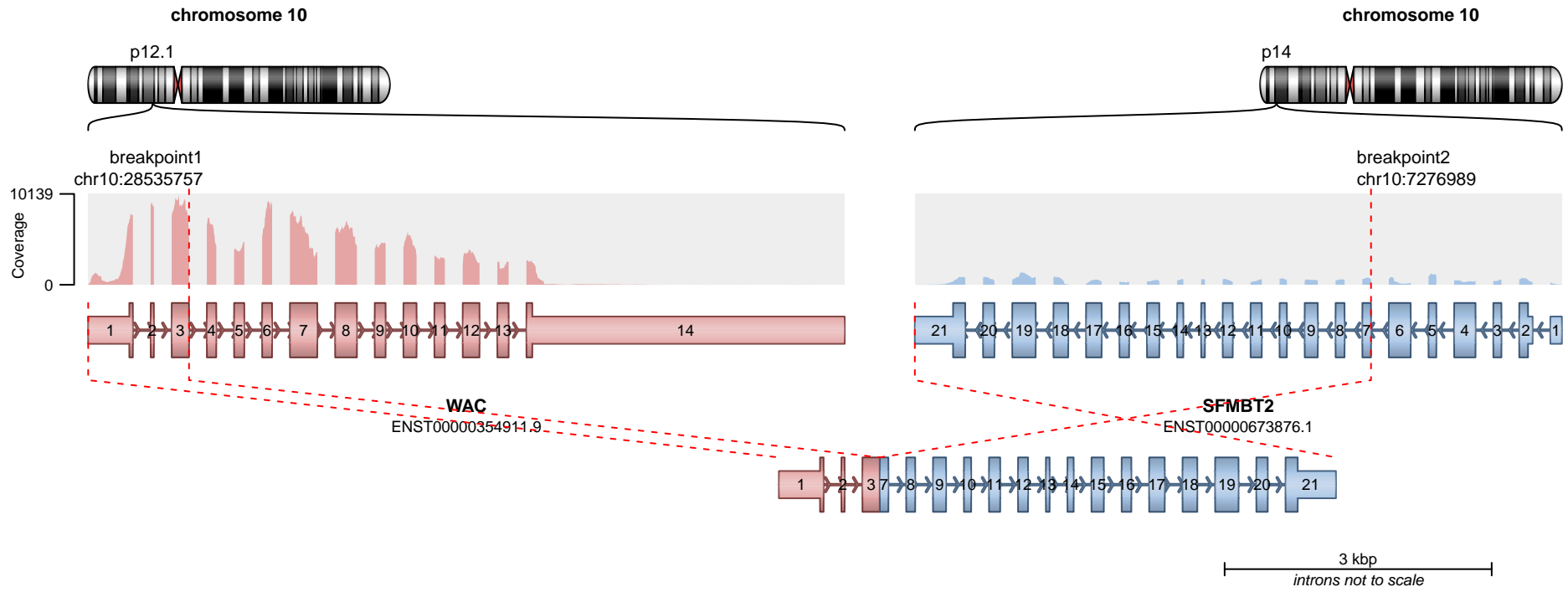

— translocation — deletion  
— duplication — inversion

**RETAINED PROTEIN DOMAINS**  
reading frame unclear

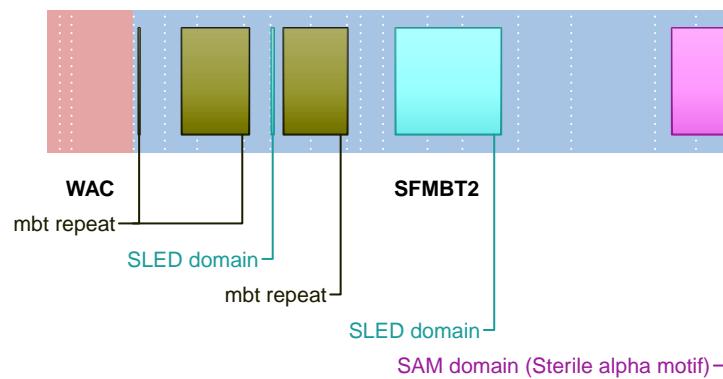

**SUPPORTING READ COUNT**

Split reads = 3  
Discordant mates = 1

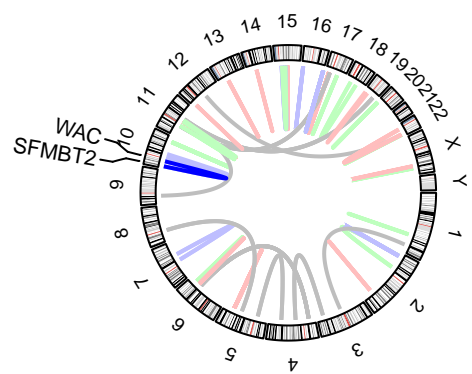
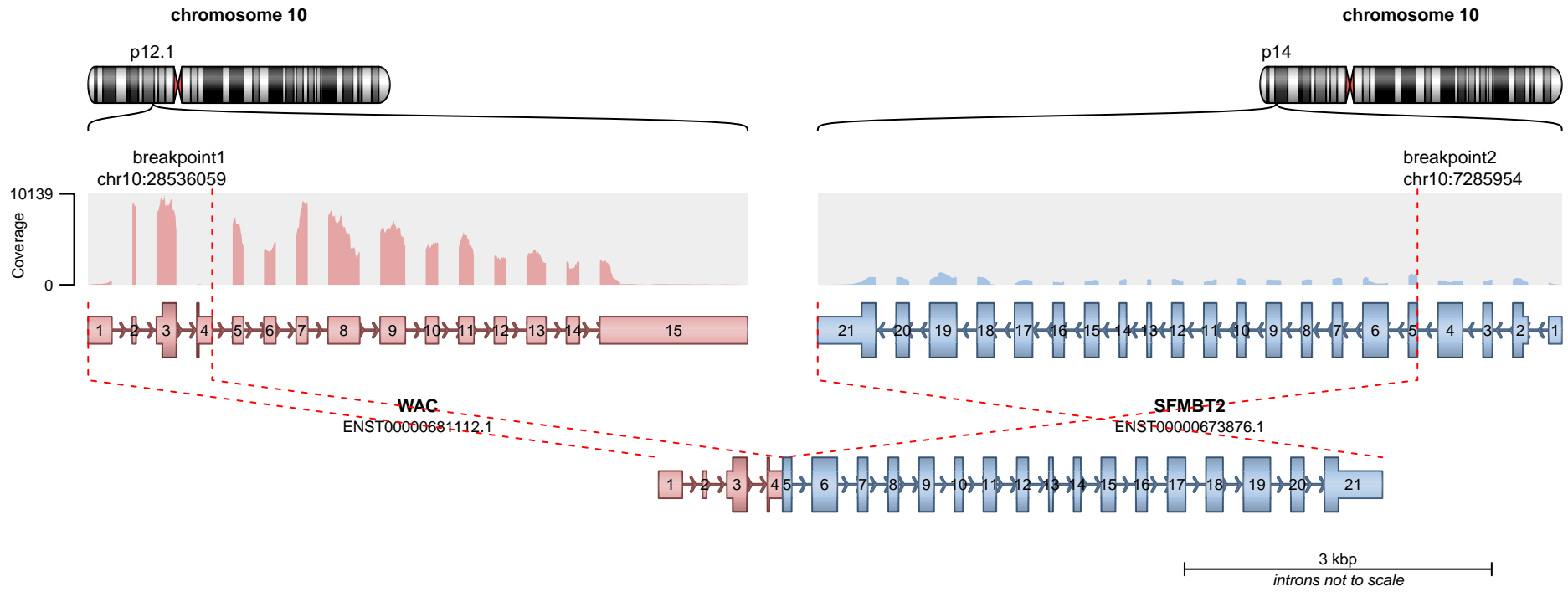

— translocation — deletion  
— duplication — inversion

**RETAINED PROTEIN DOMAINS**  
reading frame unclear

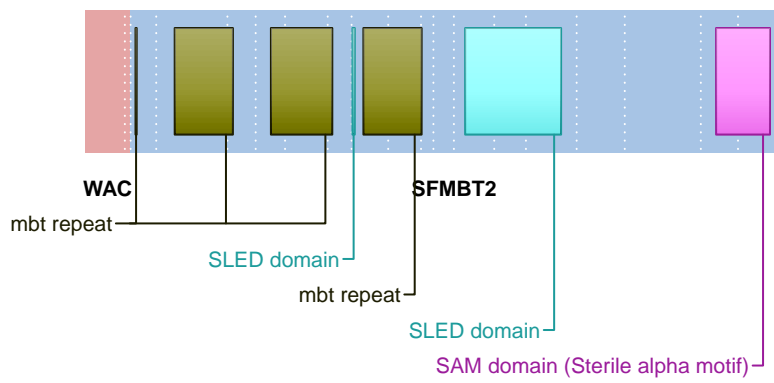

**SUPPORTING READ COUNT**

Split reads = 2  
Discordant mates = 2

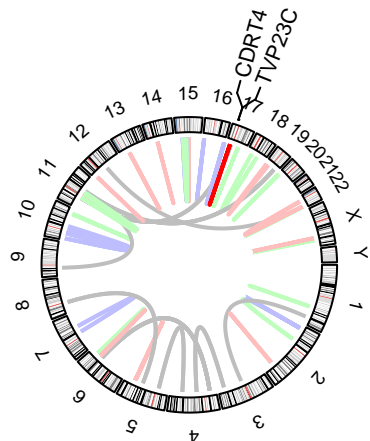
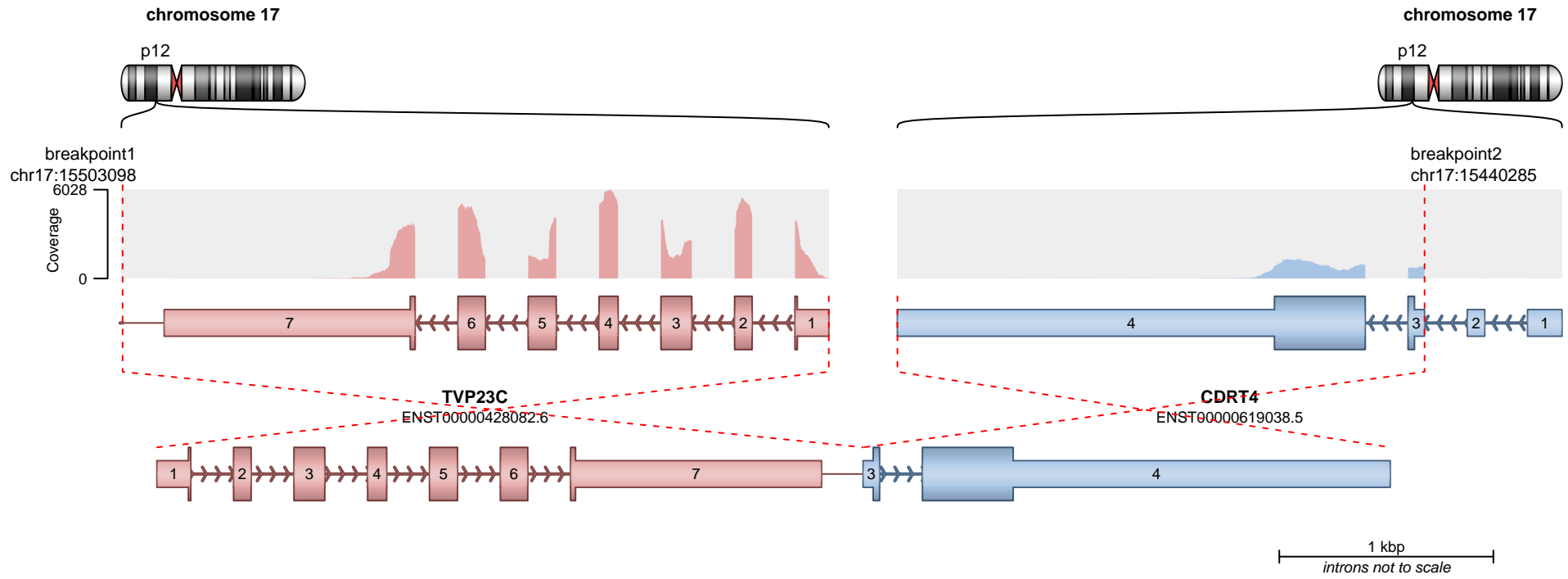

**RETAINED PROTEIN DOMAINS**  
reading frame unclear

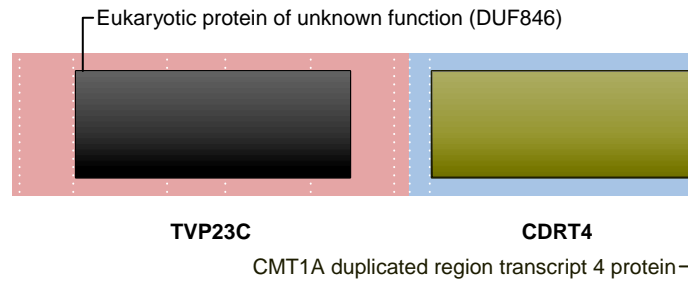

**SUPPORTING READ COUNT**

Split reads = 118  
Discordant mates = 7

— translocation — deletion  
— duplication — inversion

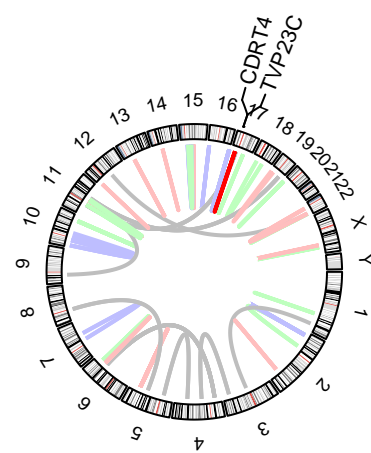
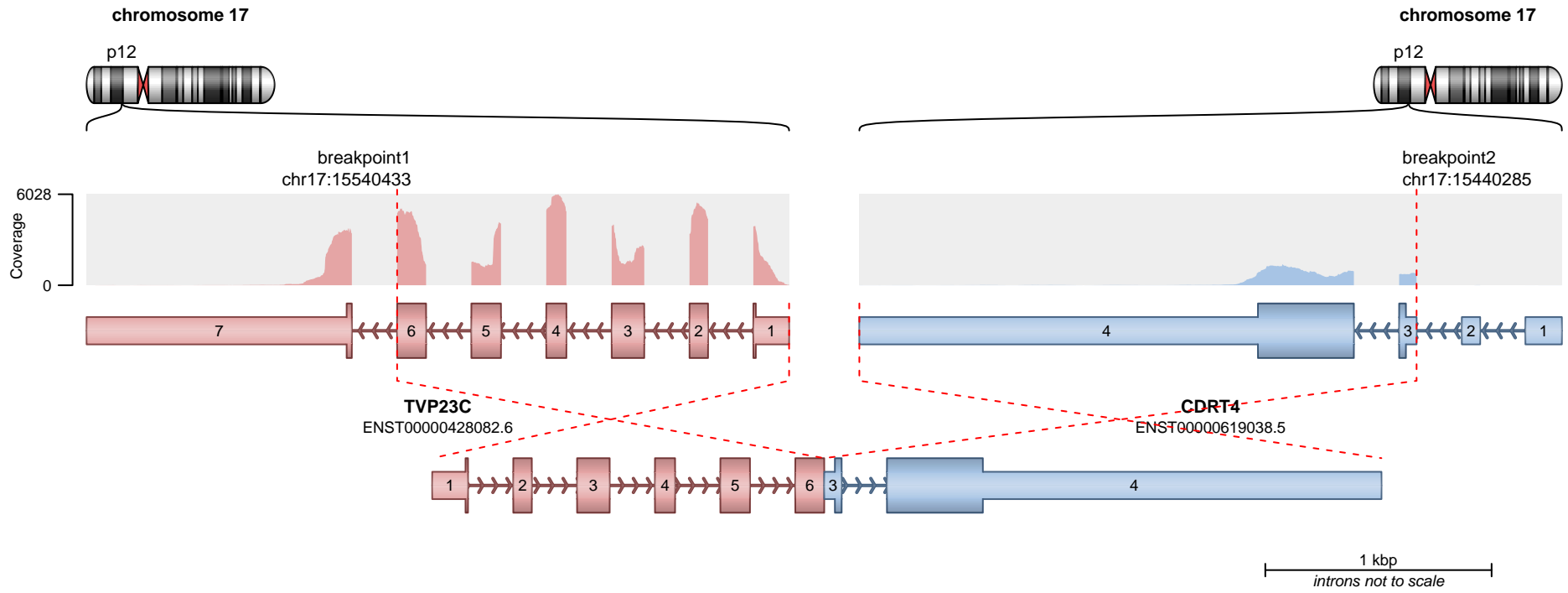

**RETAINED PROTEIN DOMAINS**  
reading frame unclear

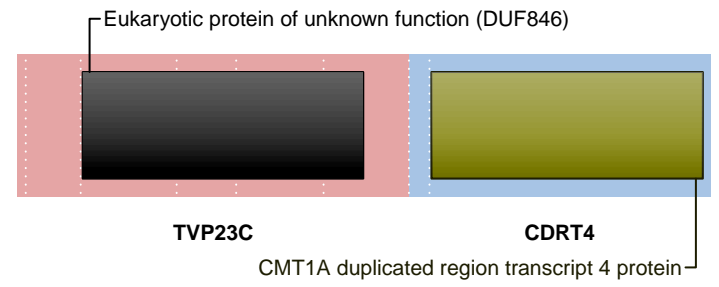

**SUPPORTING READ COUNT**

Split reads = 63  
Discordant mates = 3

- translocation
- duplication
- deletion
- inversion

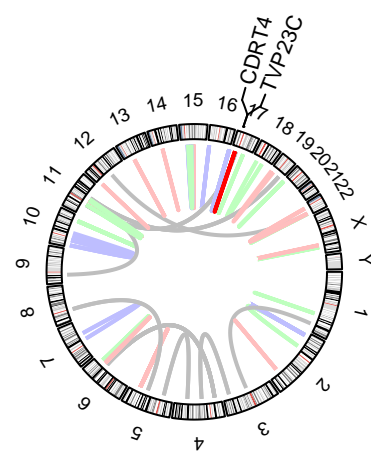
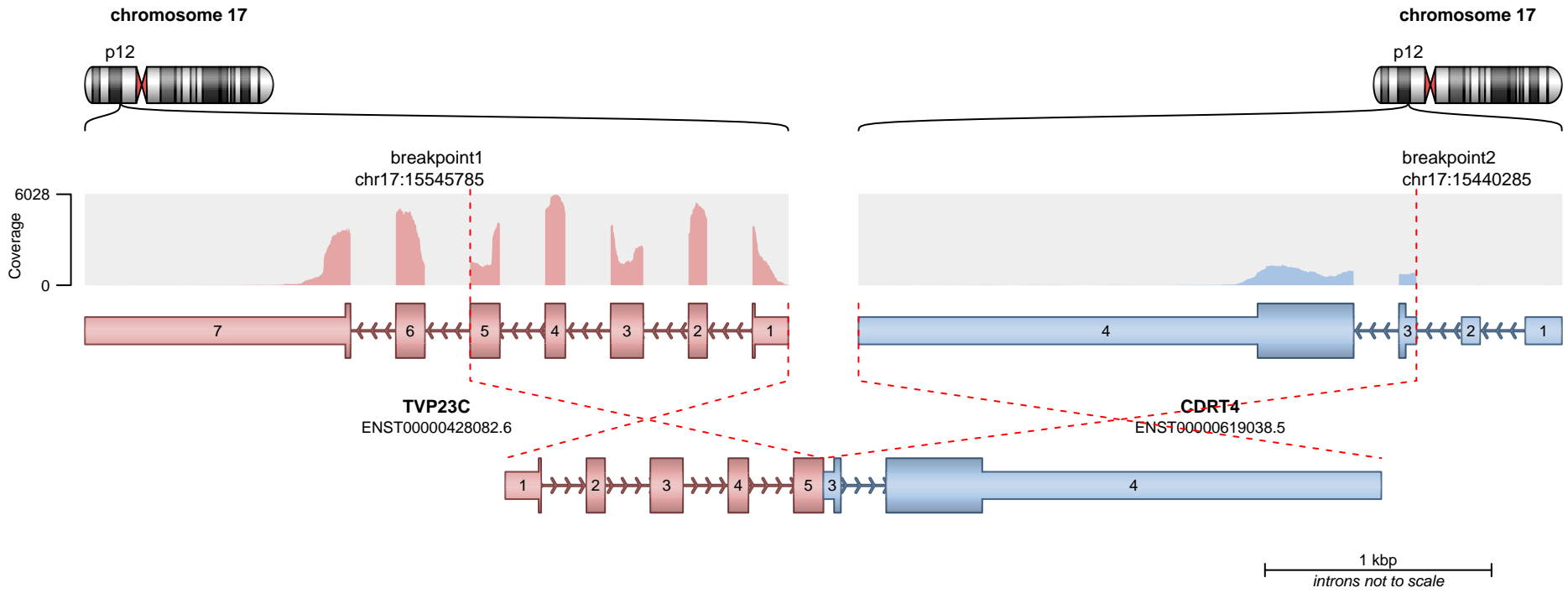

**RETAINED PROTEIN DOMAINS**  
reading frame unclear

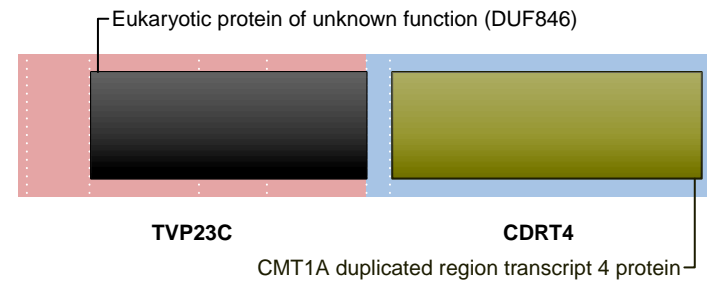

**SUPPORTING READ COUNT**

Split reads = 60  
Discordant mates = 2

- translocation
- duplication
- deletion
- inversion

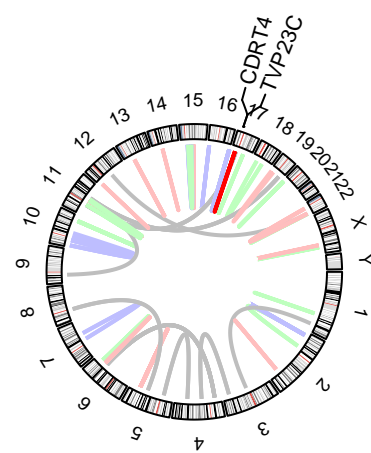
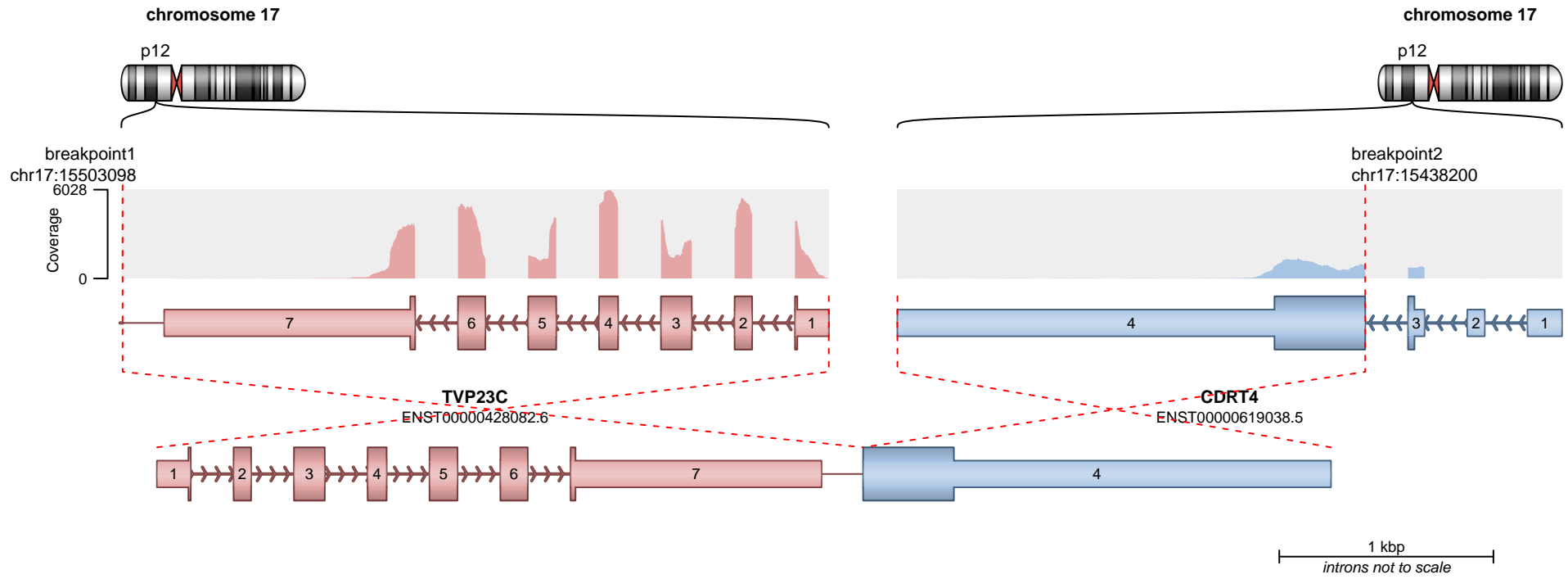

**RETAINED PROTEIN DOMAINS**  
reading frame unclear

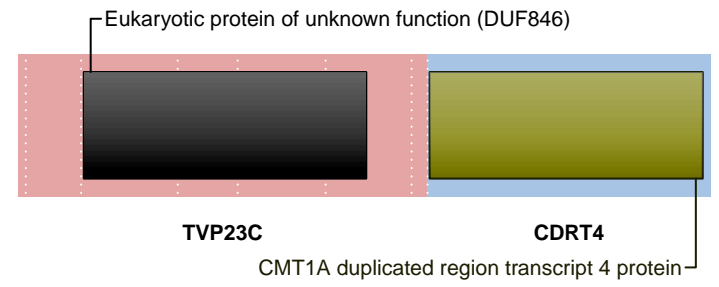

**SUPPORTING READ COUNT**

Split reads = 27  
Discordant mates = 0

- translocation
- duplication
- deletion
- inversion

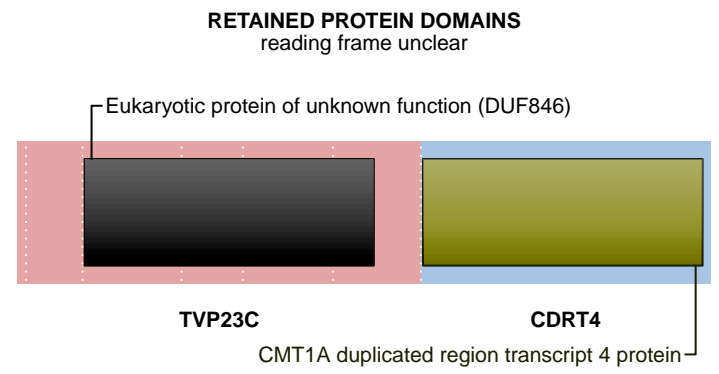
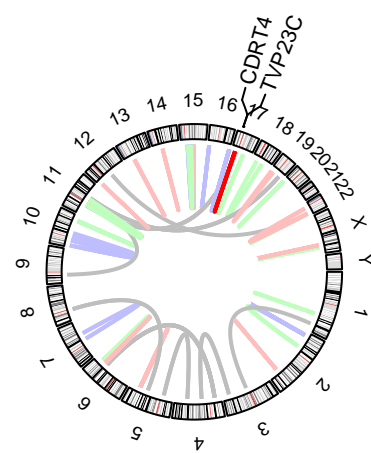
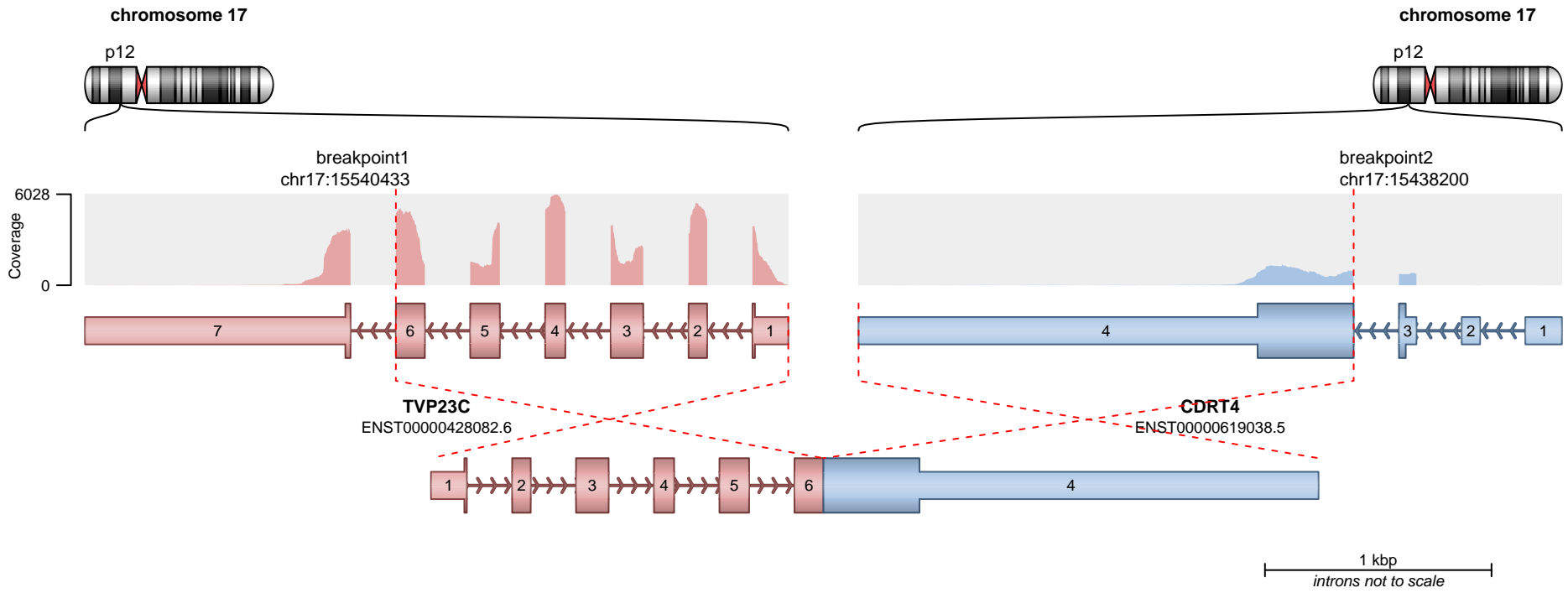

**SUPPORTING READ COUNT**

Split reads = 24  
Discordant mates = 0

— translocation — deletion  
— duplication — inversion

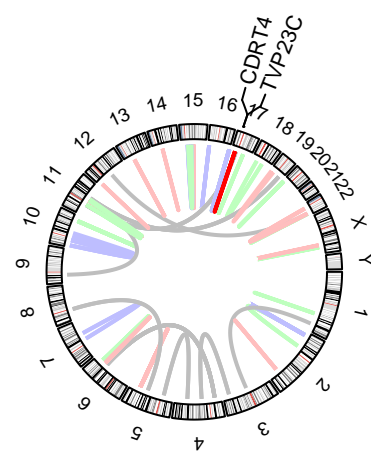
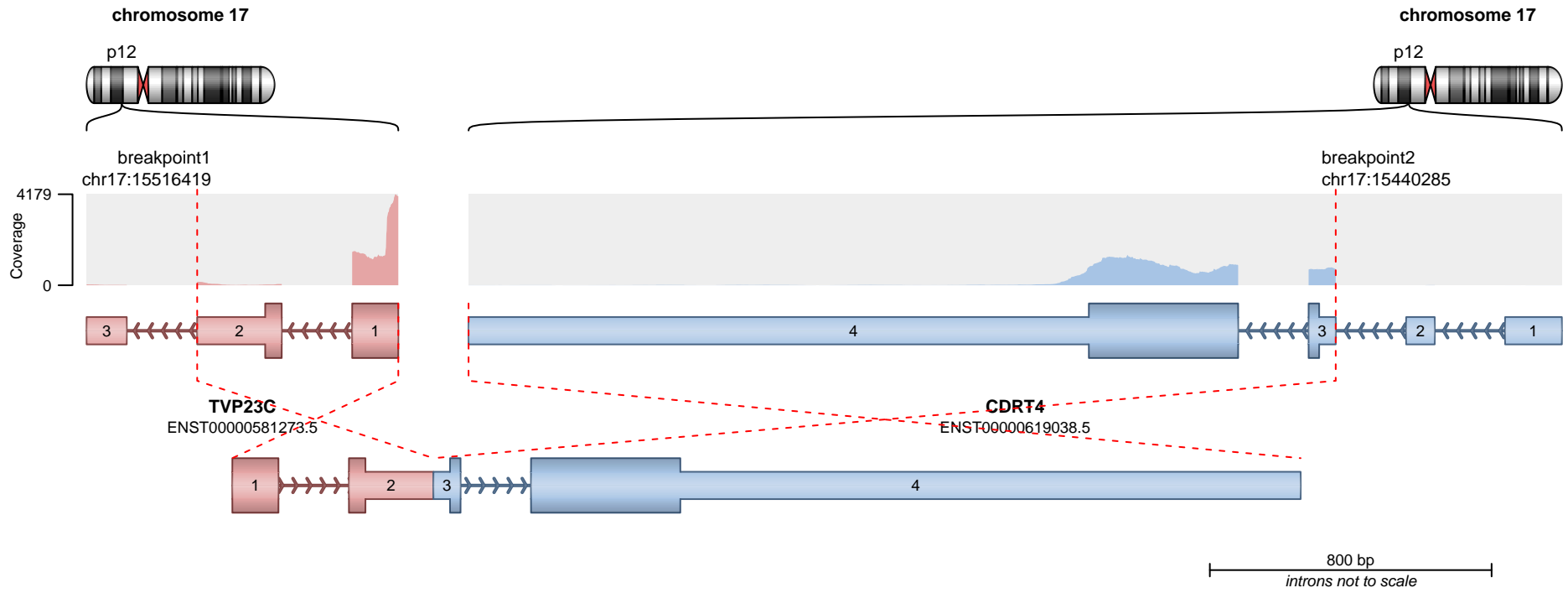

**RETAINED PROTEIN DOMAINS**  
reading frame unclear

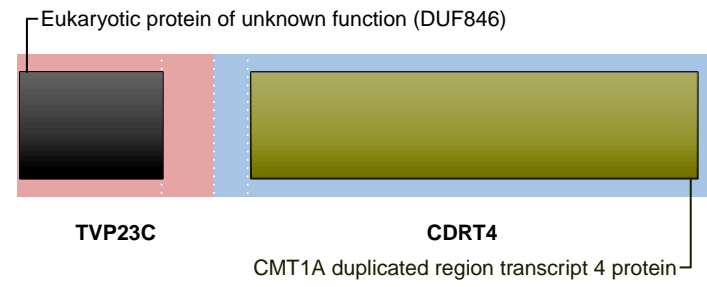

**SUPPORTING READ COUNT**

Split reads = 8  
Discordant mates = 3

— translocation — deletion  
— duplication — inversion

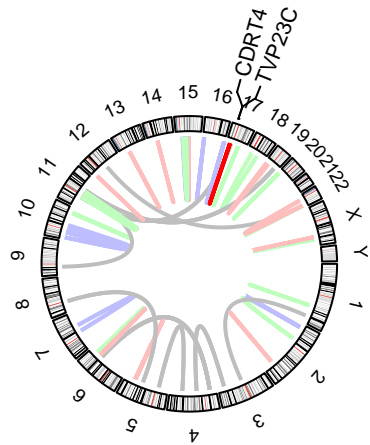
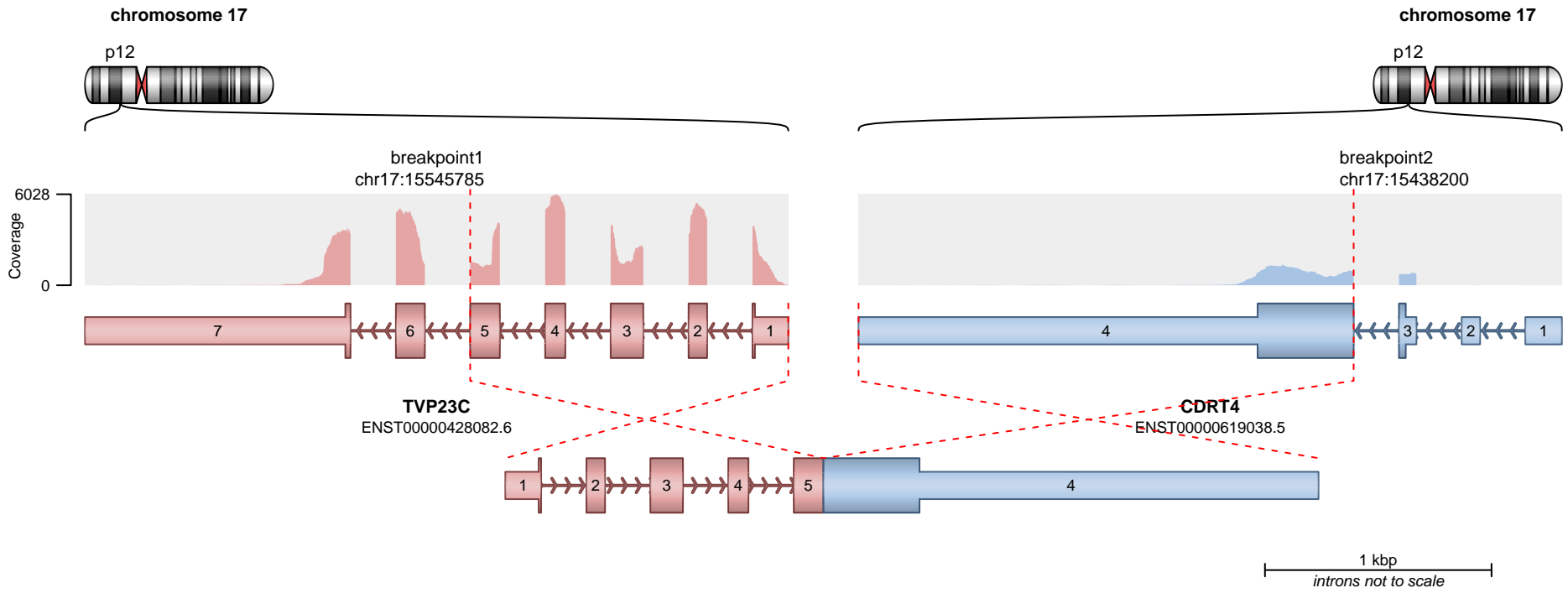

**RETAINED PROTEIN DOMAINS**  
reading frame unclear

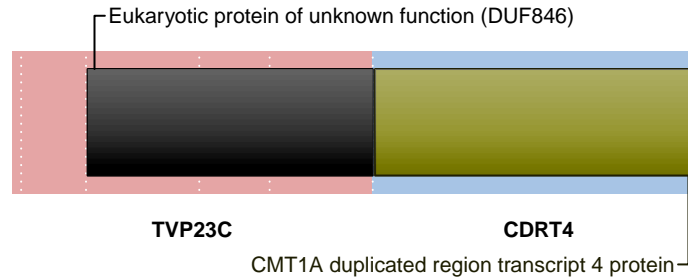

**SUPPORTING READ COUNT**

Split reads = 5  
Discordant mates = 0

— translocation — deletion  
— duplication — inversion

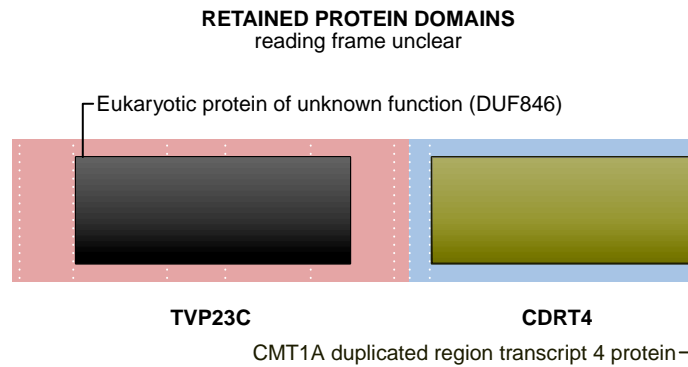
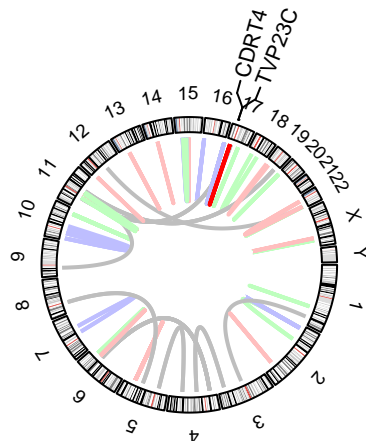
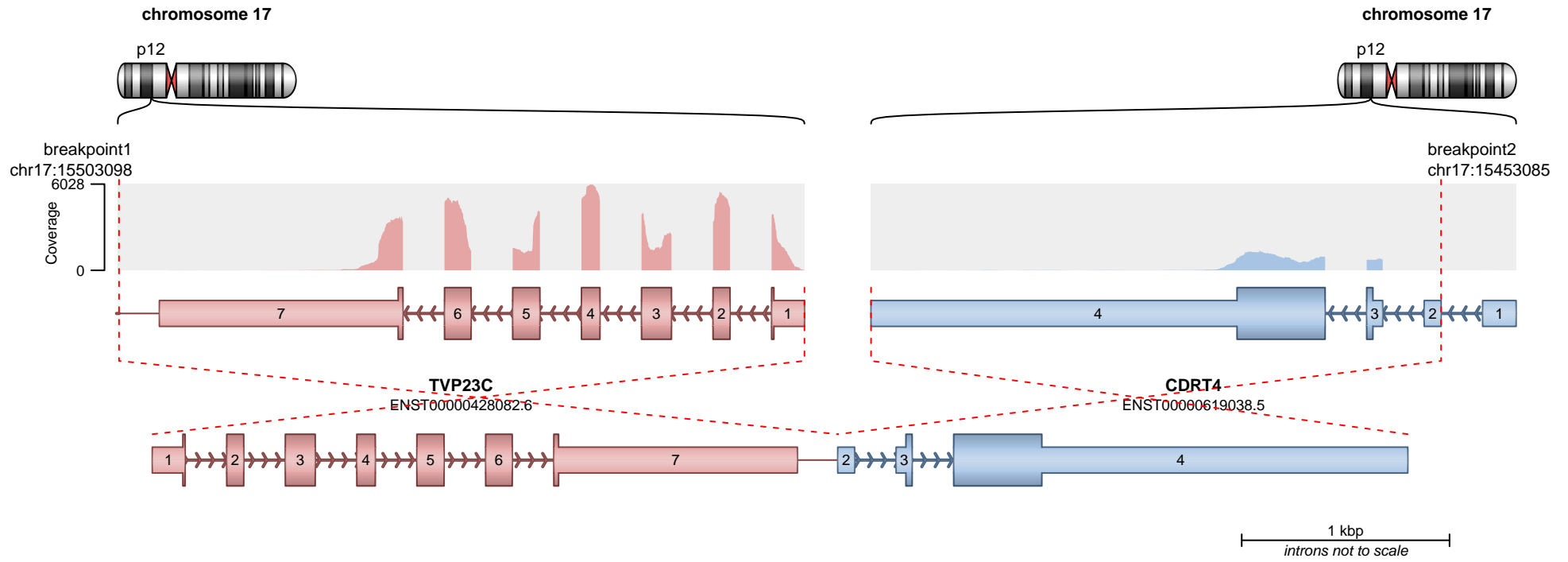

**SUPPORTING READ COUNT**

Split reads = 3  
Discordant mates = 7

— translocation — deletion  
— duplication — inversion

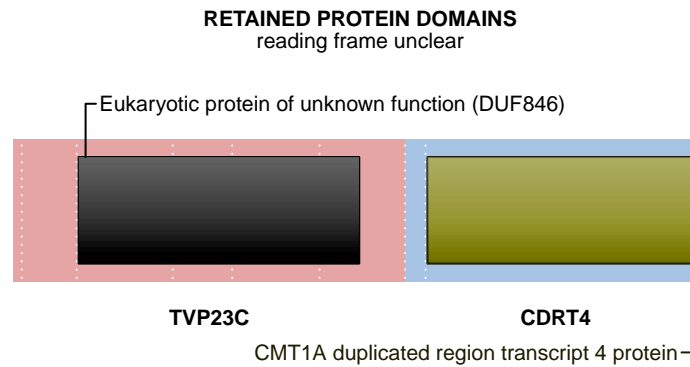
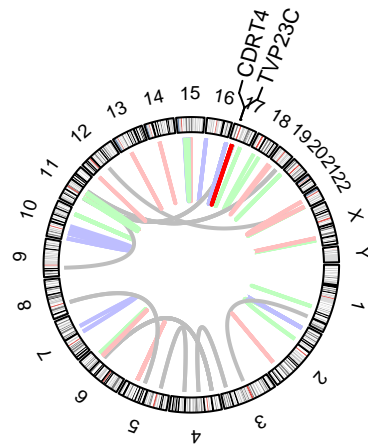
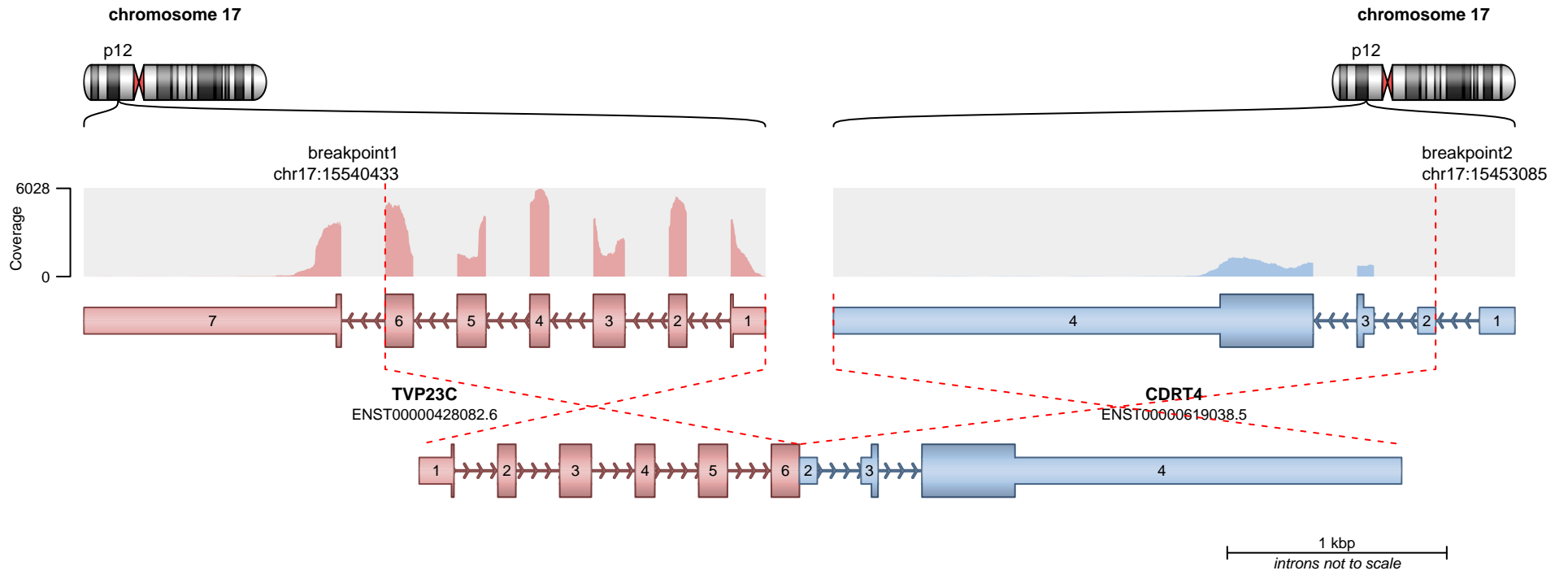

**SUPPORTING READ COUNT**

Split reads = 2  
Discordant mates = 3

— translocation — deletion  
— duplication — inversion

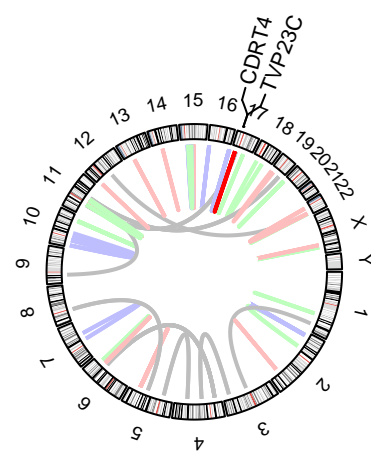
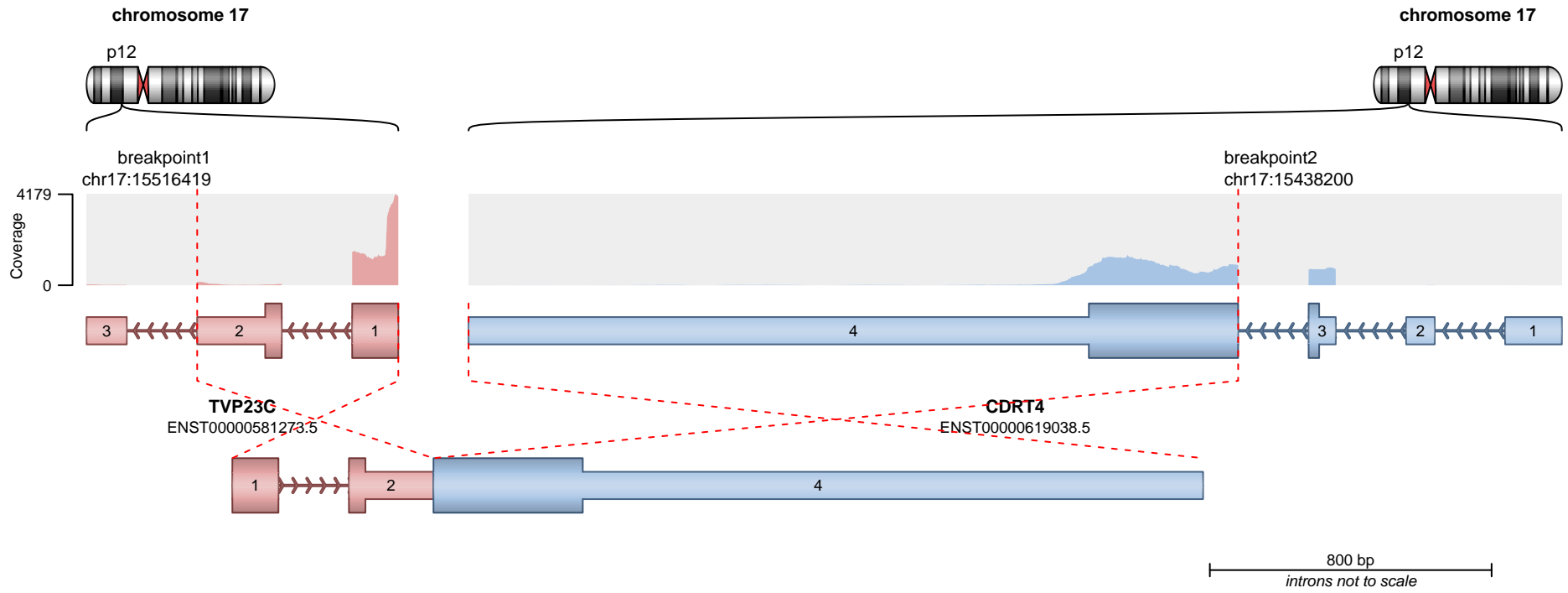

**RETAINED PROTEIN DOMAINS**  
reading frame unclear

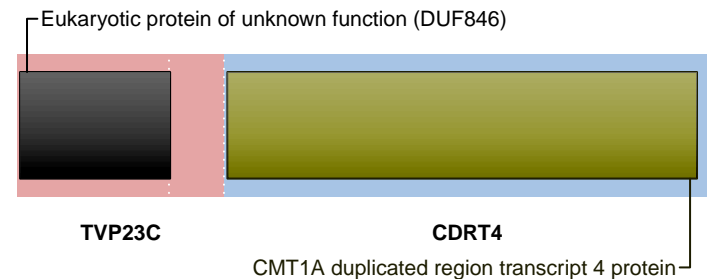

**SUPPORTING READ COUNT**

Split reads = 2  
Discordant mates = 0

- translocation
- duplication
- deletion
- inversion

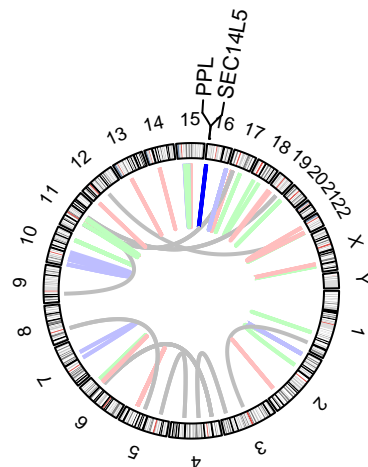
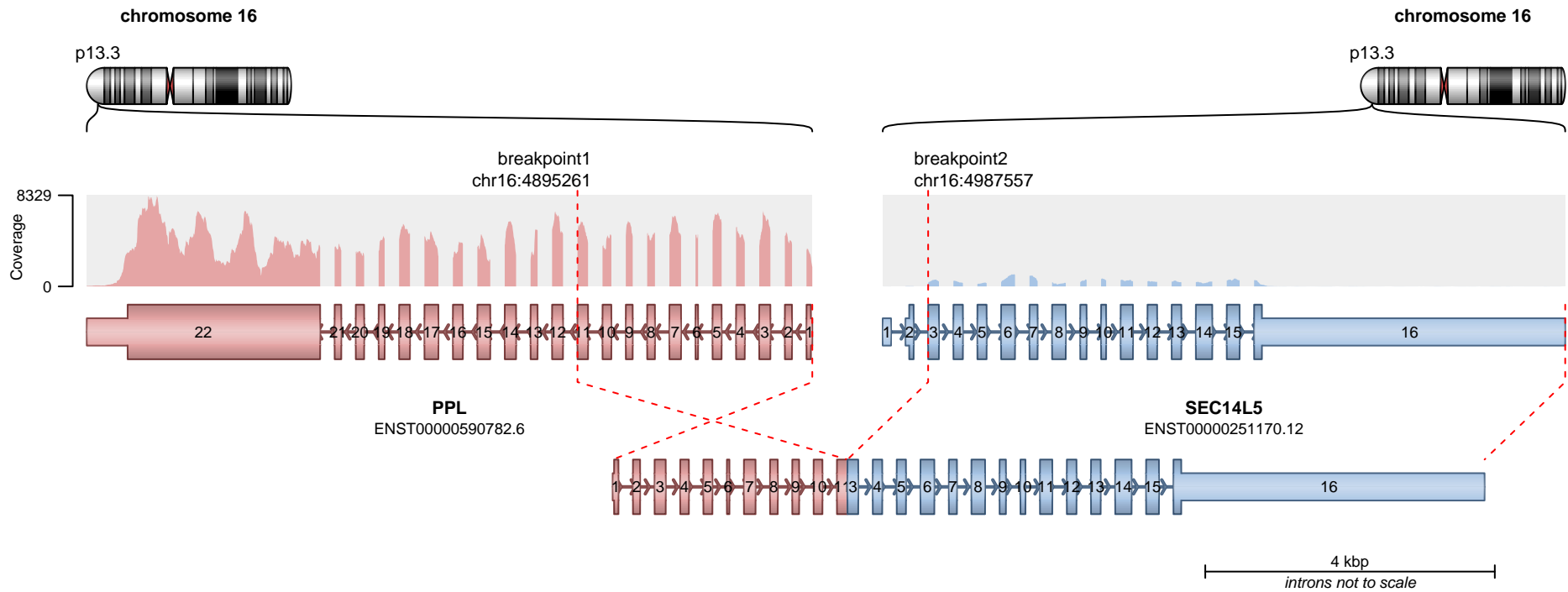

**RETAINED PROTEIN DOMAINS**  
reading frame unclear

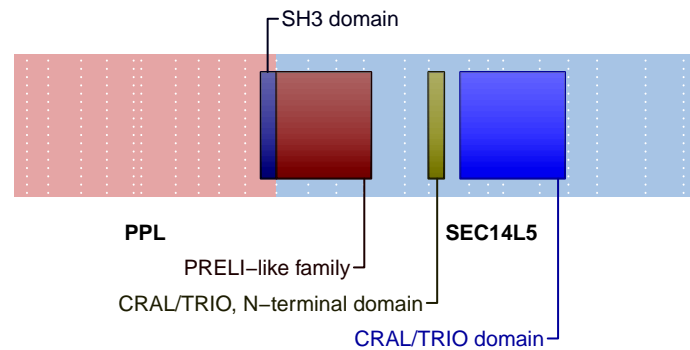

**SUPPORTING READ COUNT**

Split reads = 116  
Discordant mates = 1

- translocation
- duplication
- deletion
- inversion

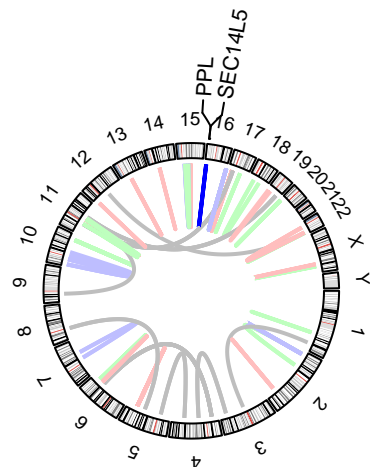
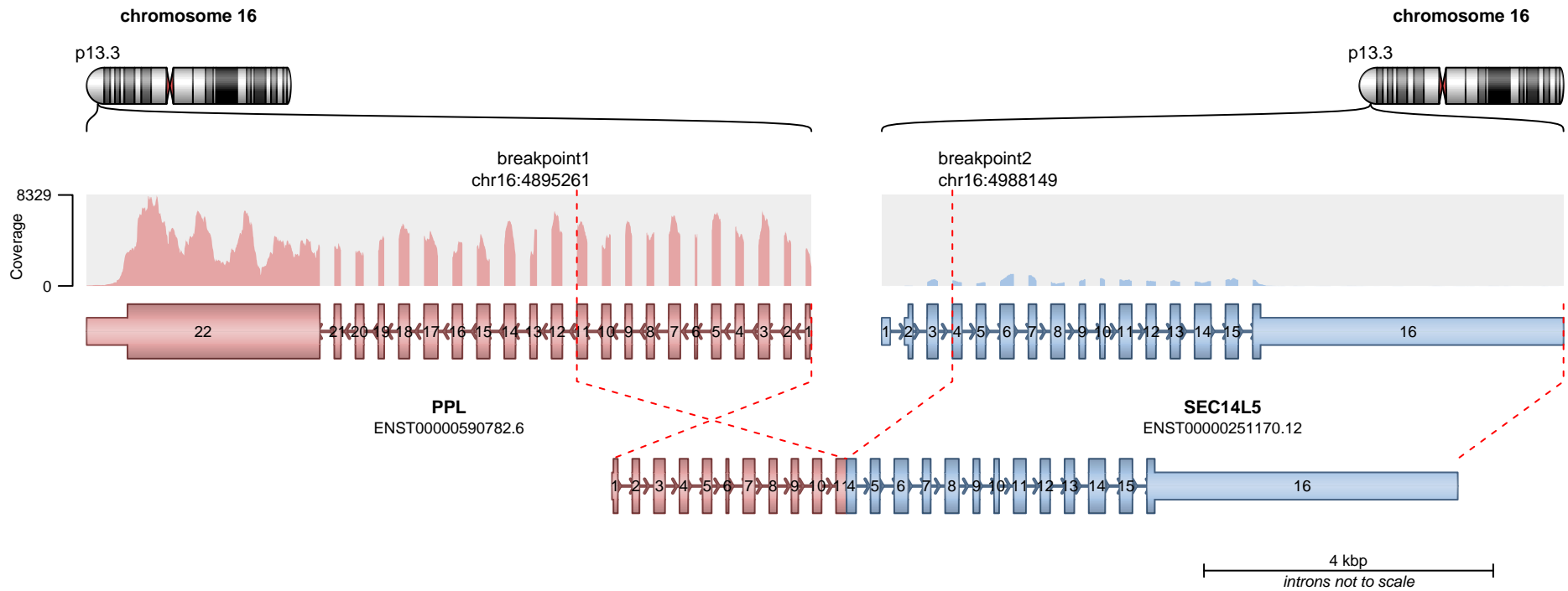

**RETAINED PROTEIN DOMAINS**  
reading frame unclear

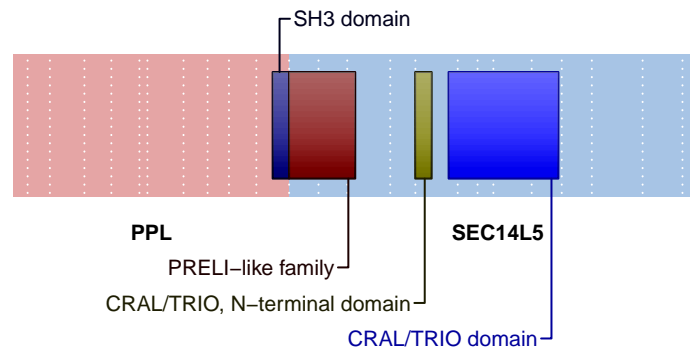

**SUPPORTING READ COUNT**

Split reads = 2  
Discordant mates = 0

— translocation — deletion  
— duplication — inversion

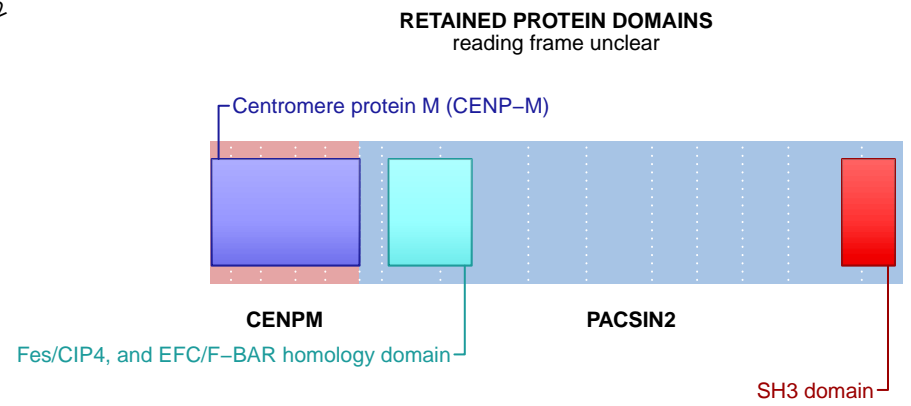
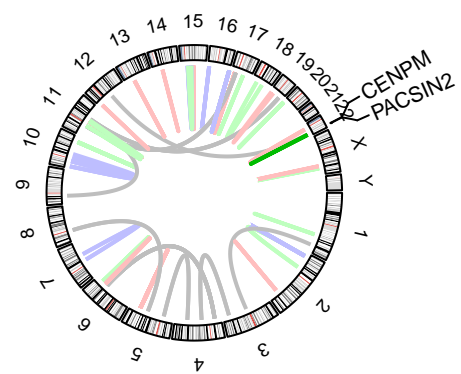
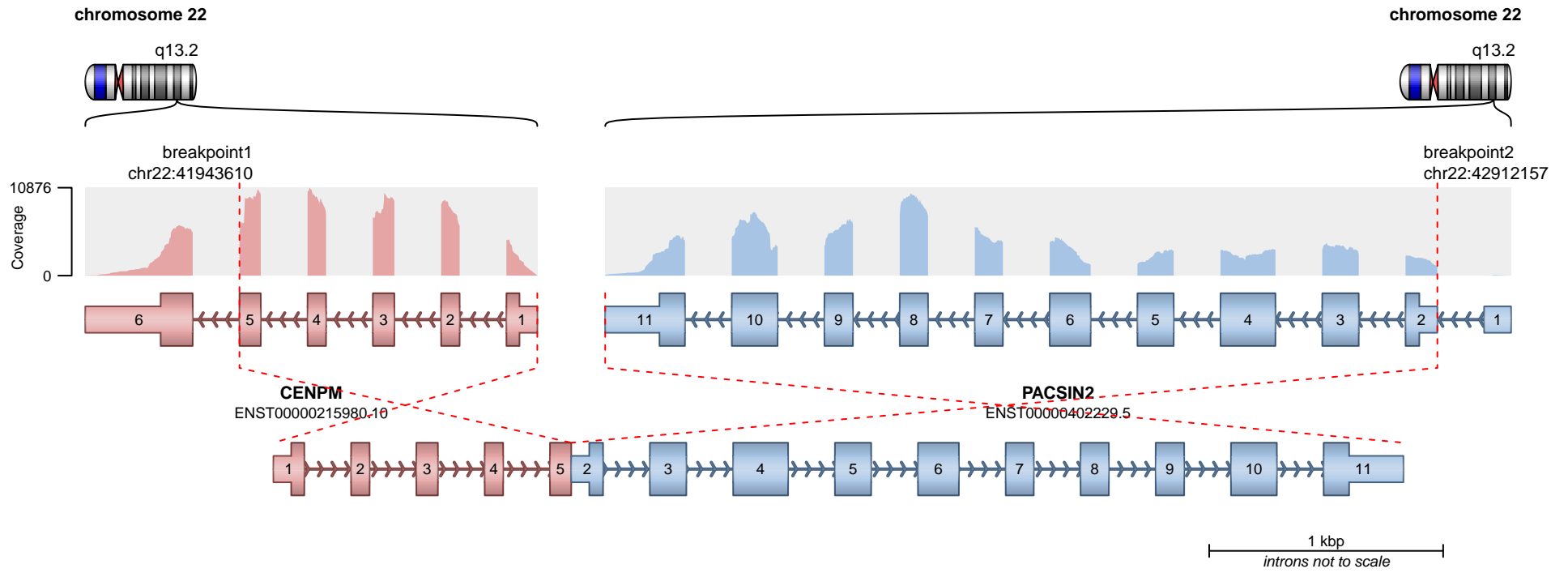

**SUPPORTING READ COUNT**

Split reads = 107  
Discordant mates = 2

— translocation    — deletion  
— duplication    — inversion

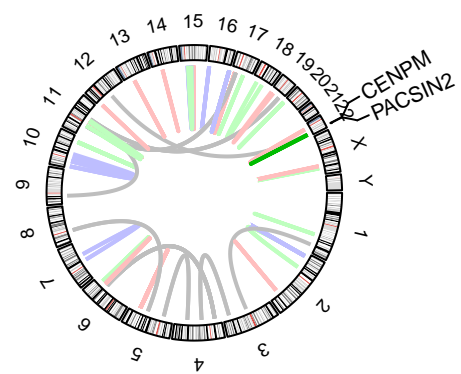
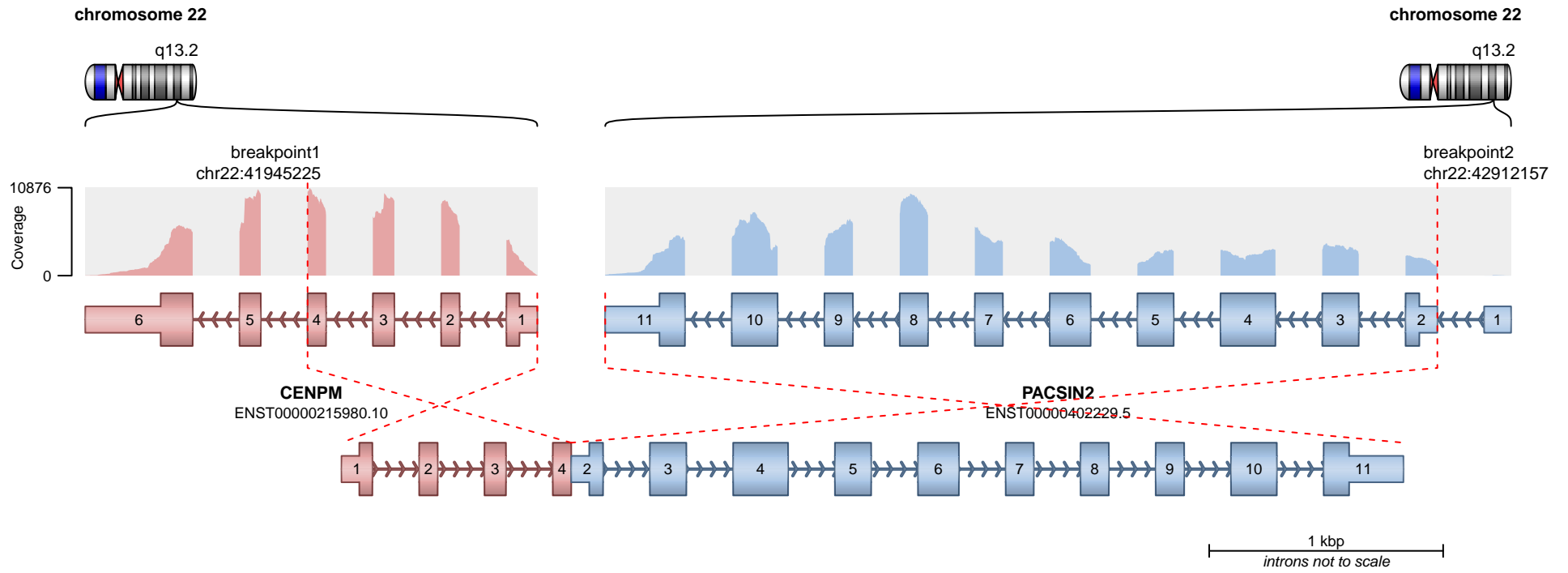

**RETAINED PROTEIN DOMAINS**  
reading frame unclear

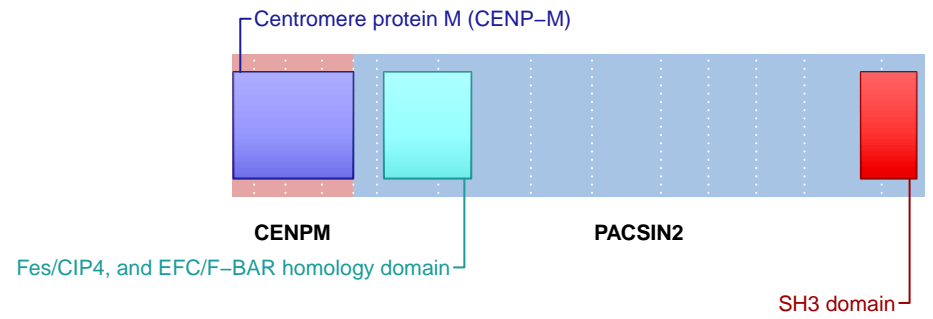

**SUPPORTING READ COUNT**

Split reads = 27  
Discordant mates = 1

- translocation
- duplication
- deletion
- inversion

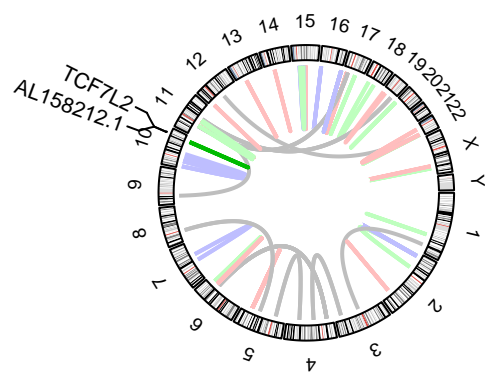
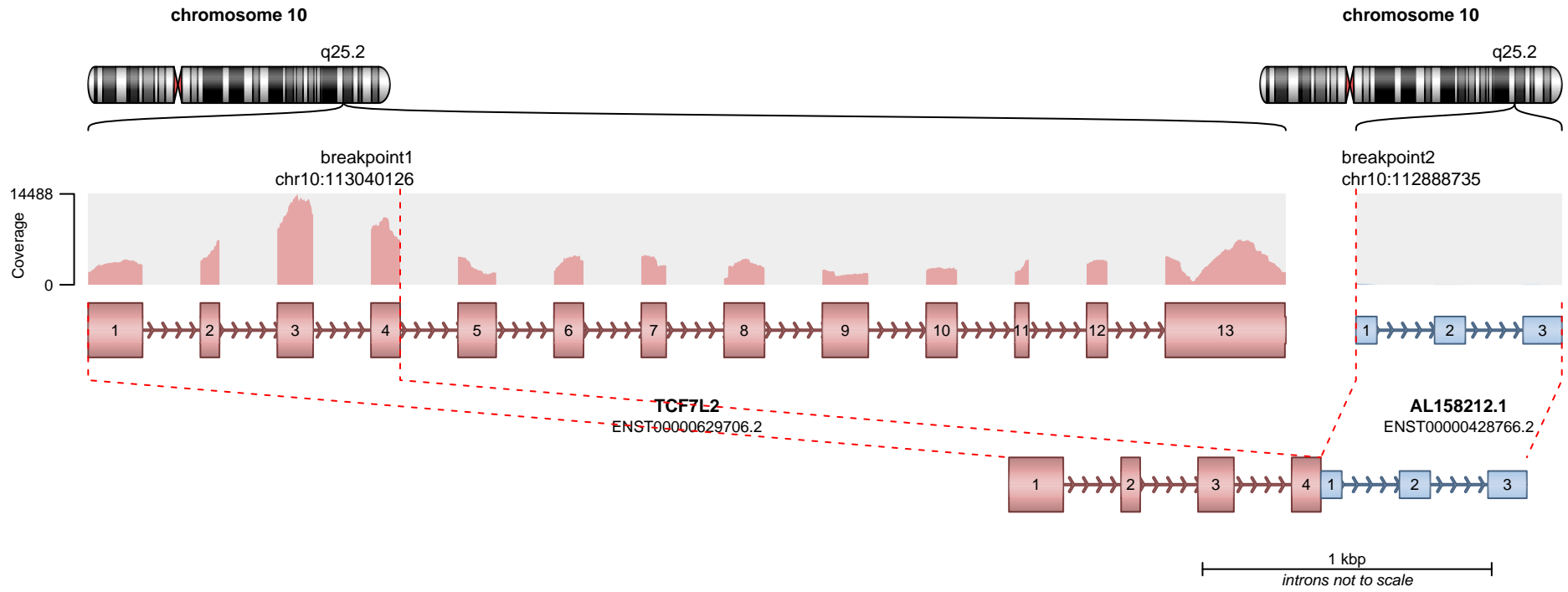

**RETAINED PROTEIN DOMAINS**  
reading frame unclear

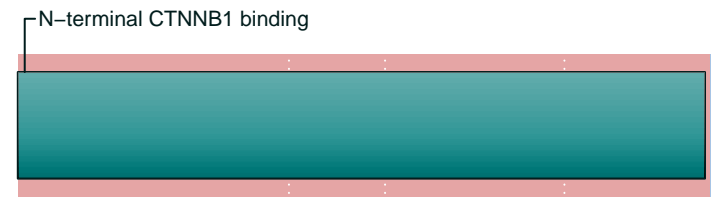

**TCF7L2**

**SUPPORTING READ COUNT**

Split reads = 98  
Discordant mates = 1

- translocation
- duplication
- deletion
- inversion

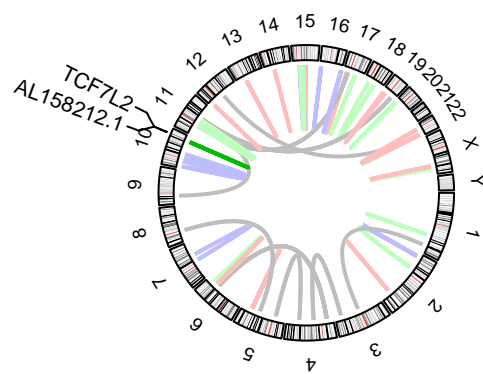
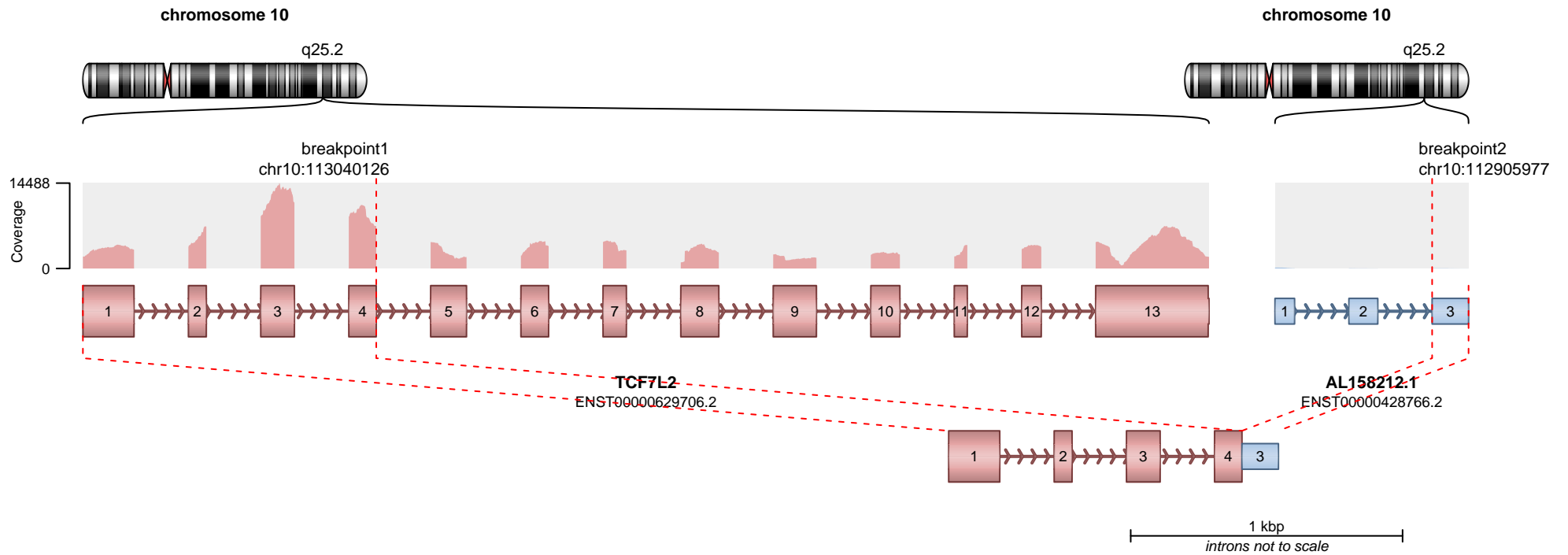

**RETAINED PROTEIN DOMAINS**  
reading frame unclear

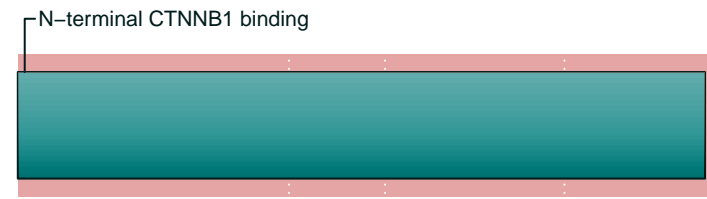

**SUPPORTING READ COUNT**

Split reads = 16  
Discordant mates = 1

- translocation
- duplication
- deletion
- inversion

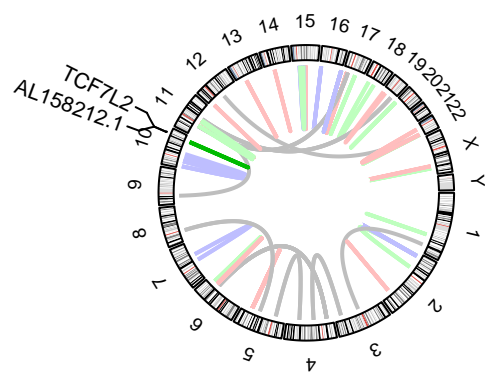
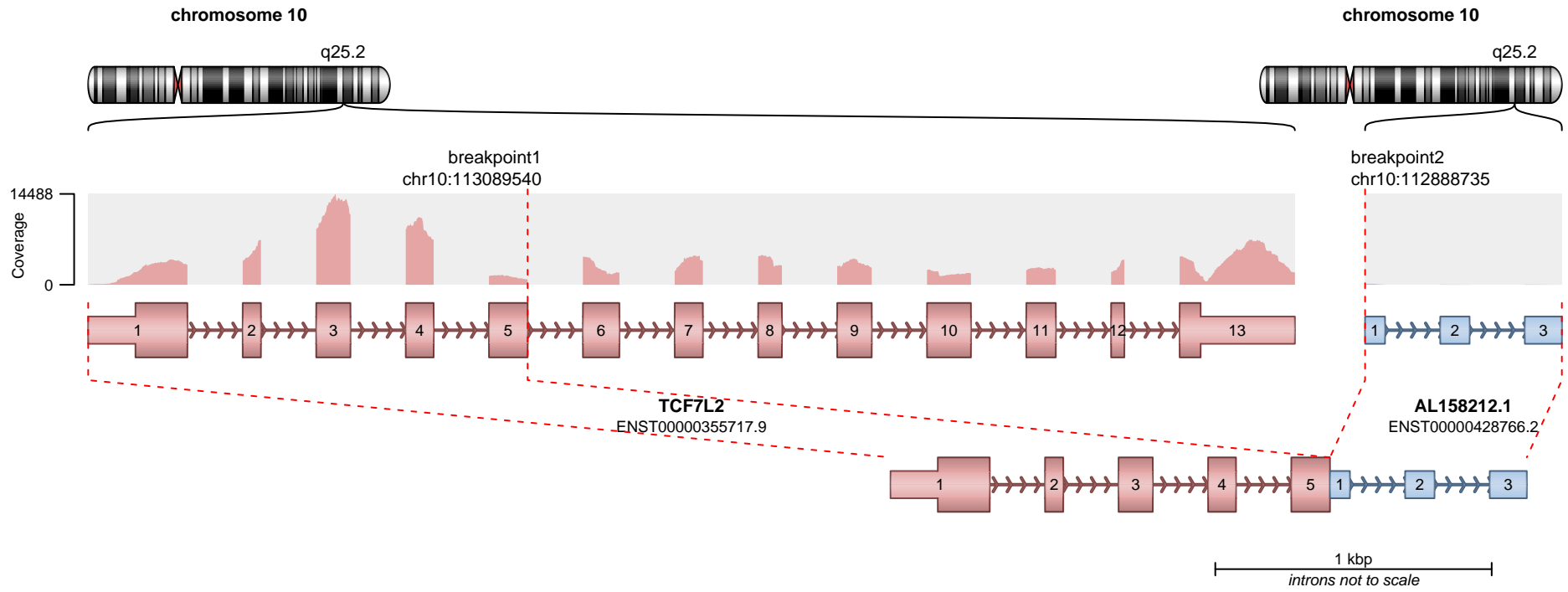

**RETAINED PROTEIN DOMAINS**  
reading frame unclear

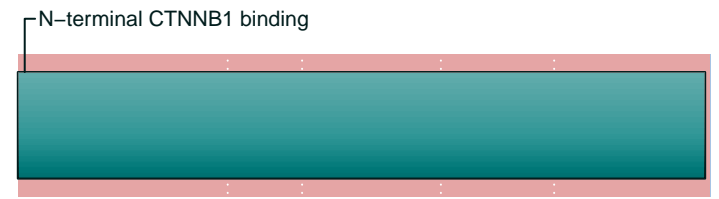

**TCF7L2**

**SUPPORTING READ COUNT**

Split reads = 13  
Discordant mates = 1

- translocation
- duplication
- deletion
- inversion

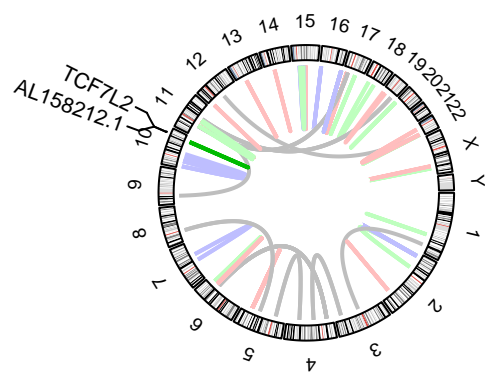
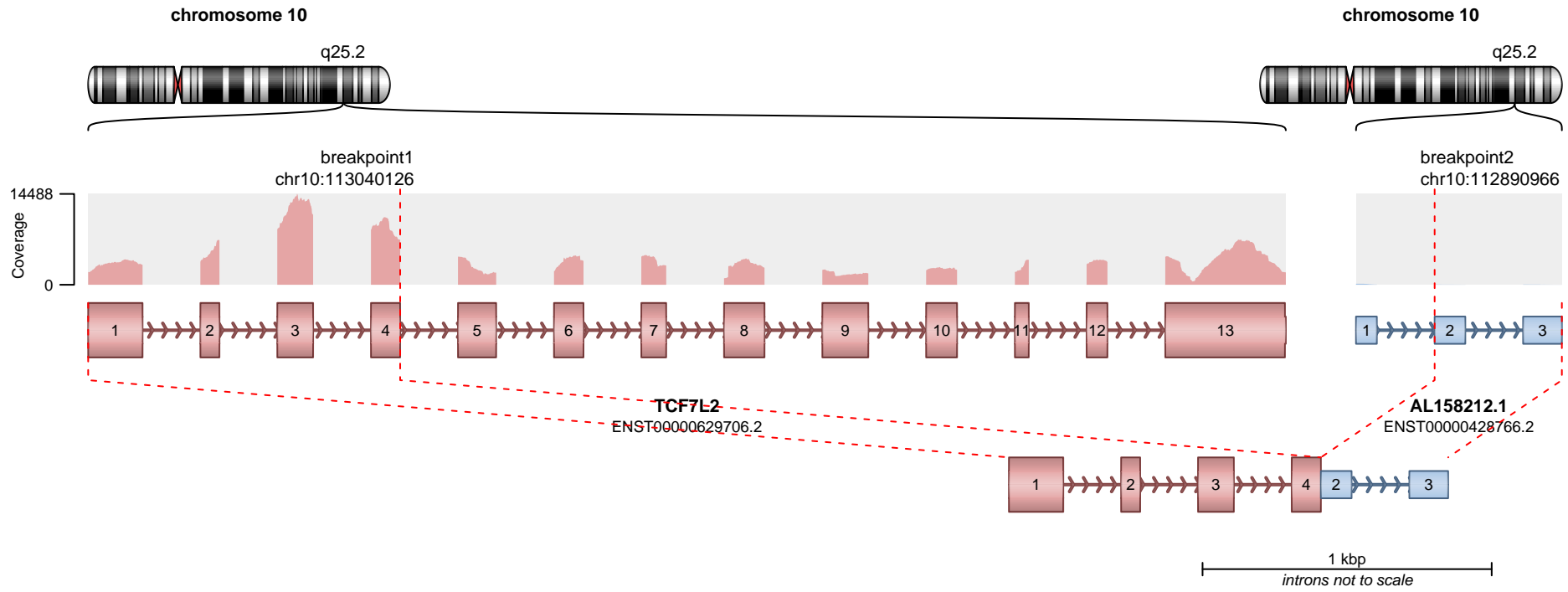

**RETAINED PROTEIN DOMAINS**  
reading frame unclear

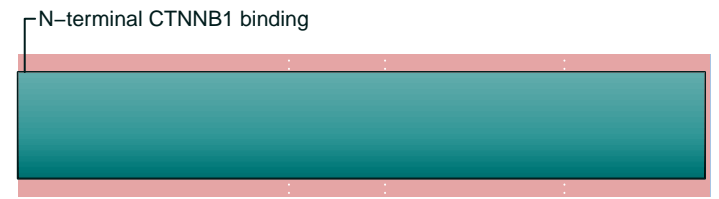

**SUPPORTING READ COUNT**

Split reads = 11  
Discordant mates = 1

- translocation
- duplication
- deletion
- inversion

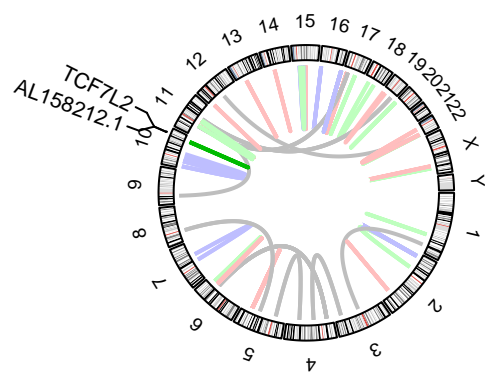
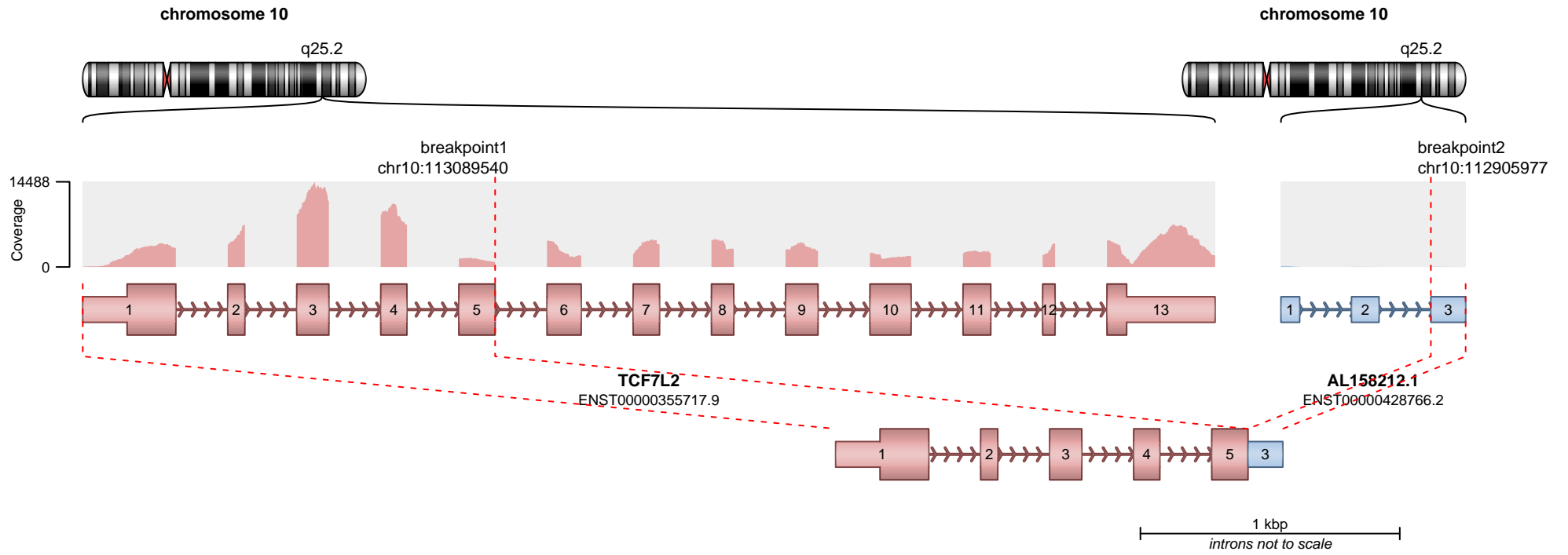

**RETAINED PROTEIN DOMAINS**  
reading frame unclear

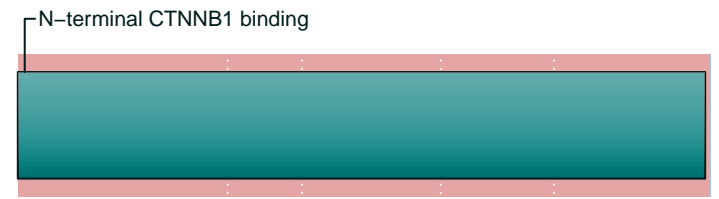

**SUPPORTING READ COUNT**

Split reads = 2  
Discordant mates = 1

- translocation
- duplication
- deletion
- inversion

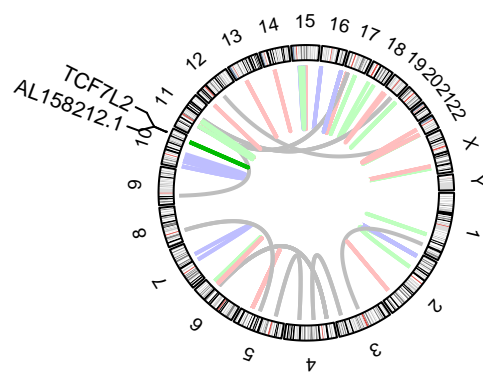
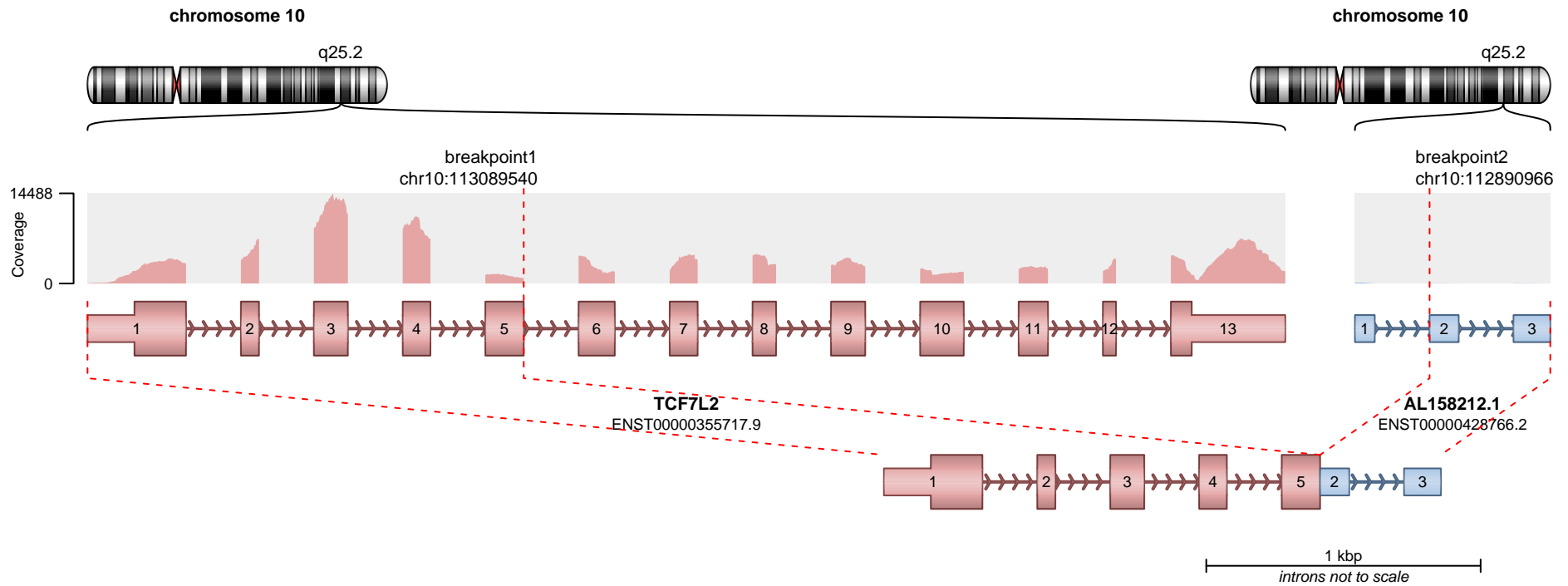

**RETAINED PROTEIN DOMAINS**  
reading frame unclear

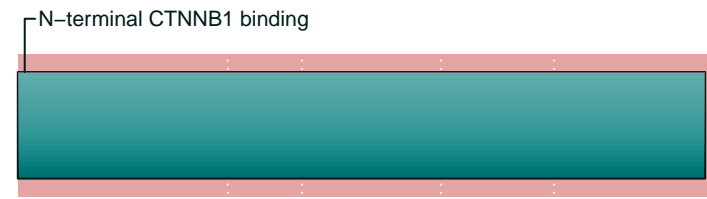

**SUPPORTING READ COUNT**

Split reads = 1  
Discordant mates = 1

- translocation
- duplication
- deletion
- inversion

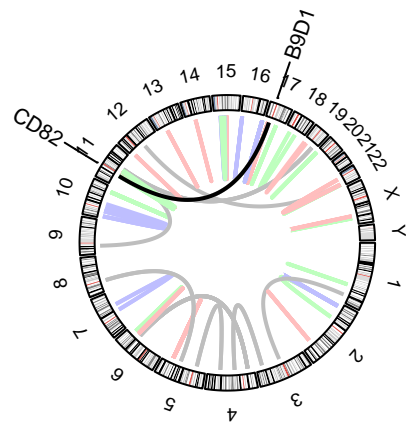
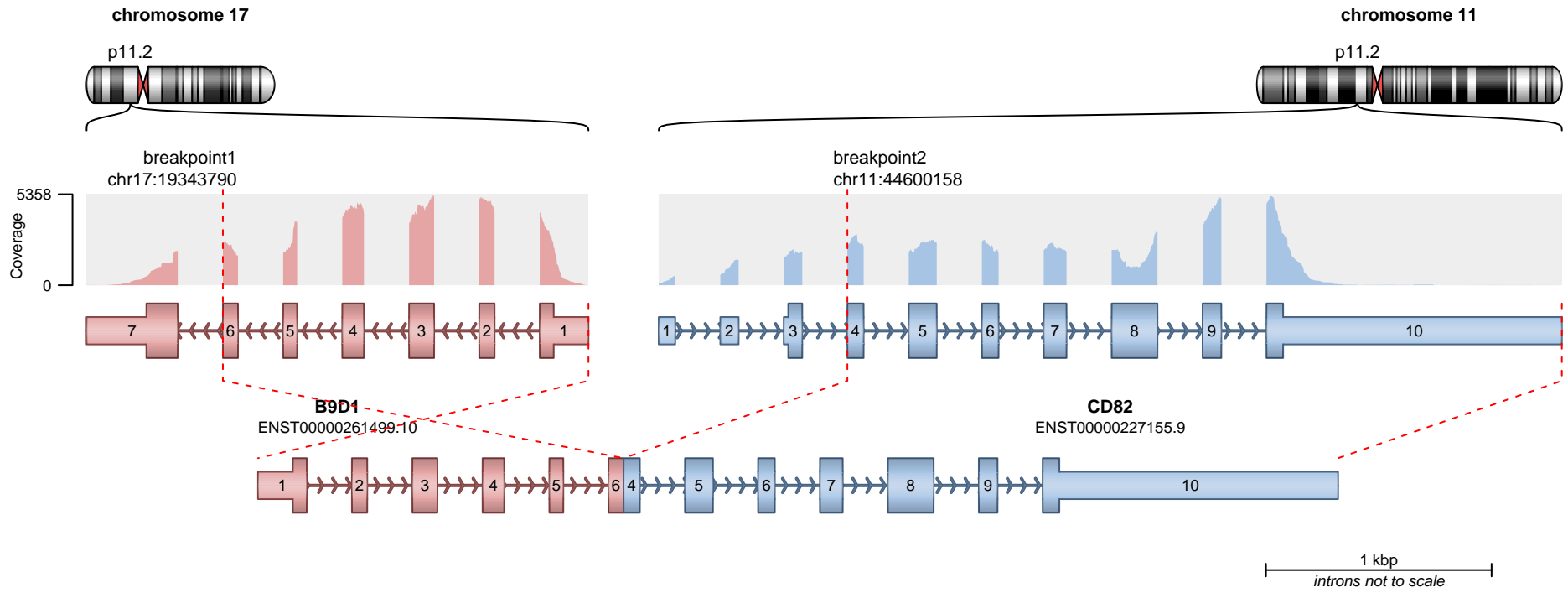

**RETAINED PROTEIN DOMAINS**  
reading frame unclear

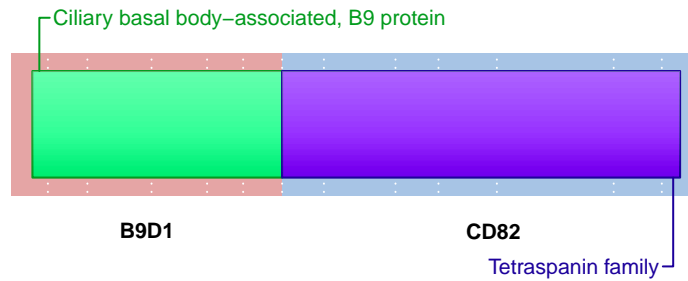

**SUPPORTING READ COUNT**

Split reads = 96  
Discordant mates = 2

— translocation — deletion  
— duplication — inversion

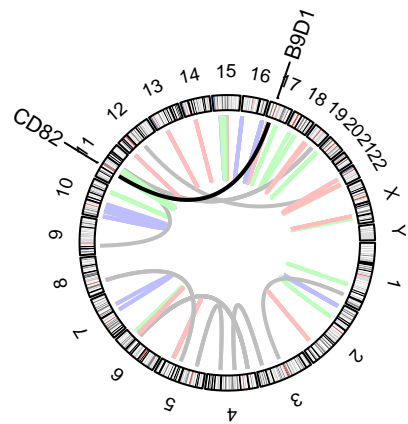
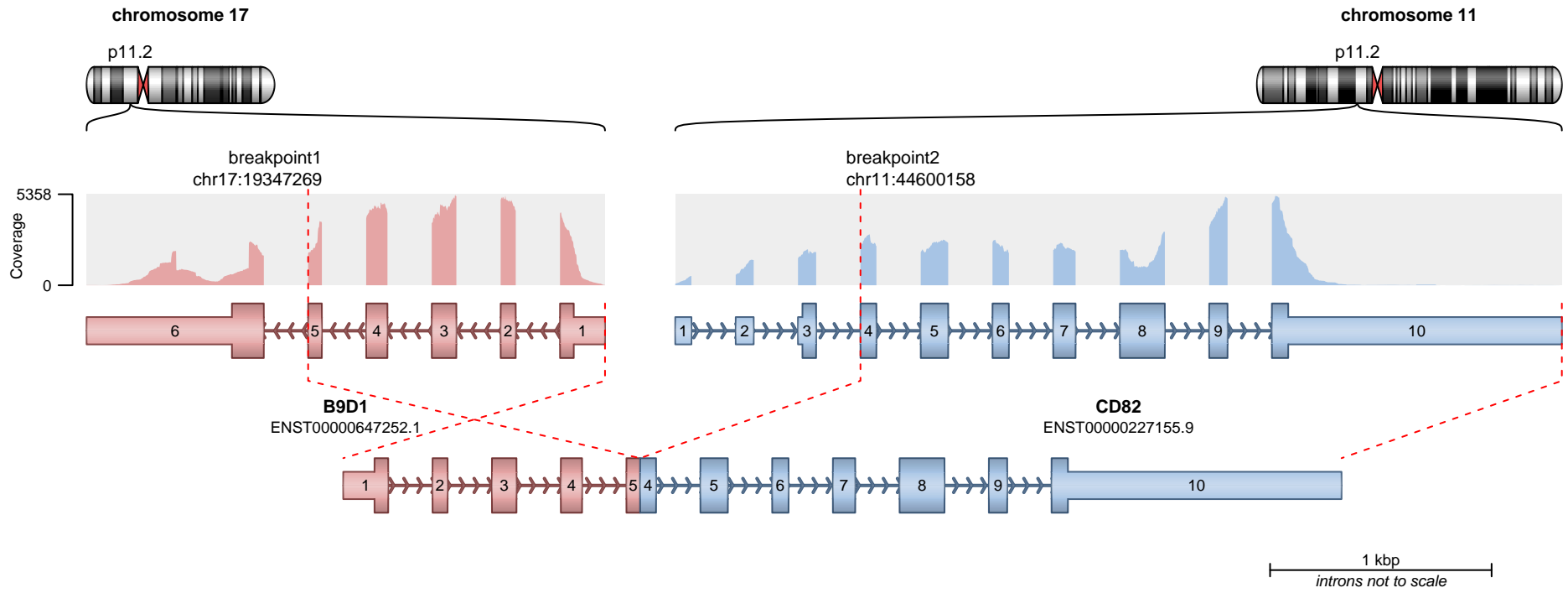

**RETAINED PROTEIN DOMAINS**  
reading frame unclear

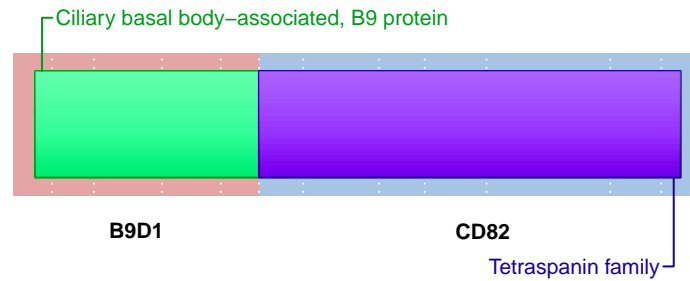

**SUPPORTING READ COUNT**

Split reads = 11  
Discordant mates = 2

- translocation
- duplication
- deletion
- inversion

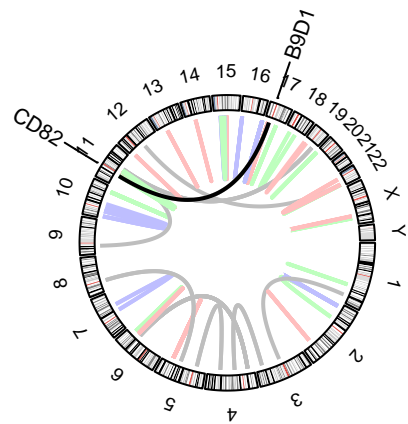
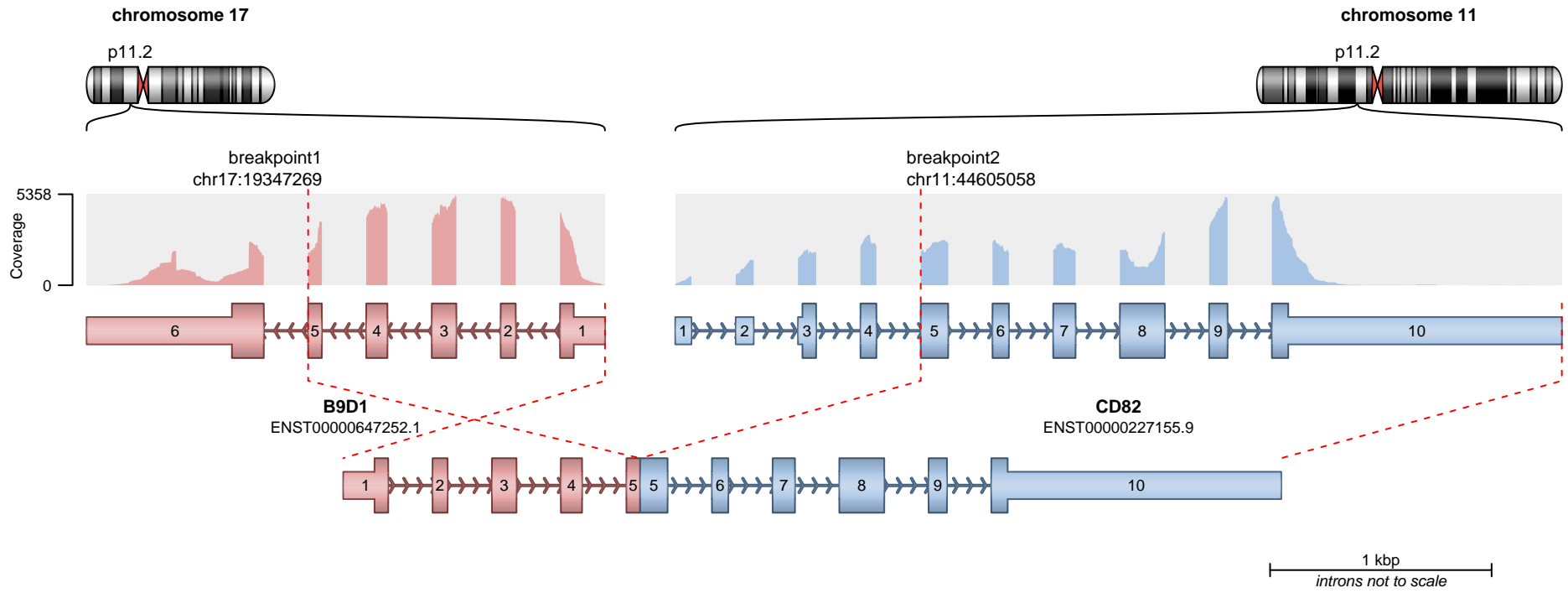

**RETAINED PROTEIN DOMAINS**  
reading frame unclear

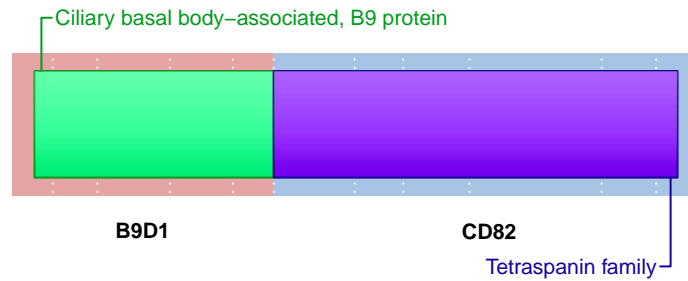

**SUPPORTING READ COUNT**

Split reads = 2  
Discordant mates = 0

- translocation
- duplication
- deletion
- inversion

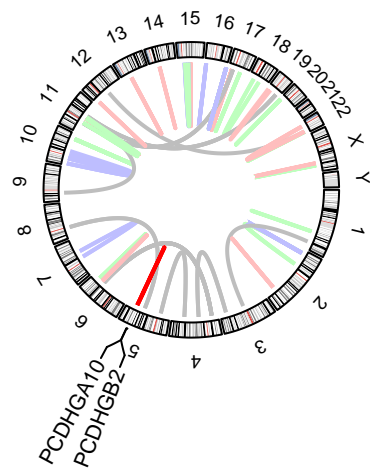
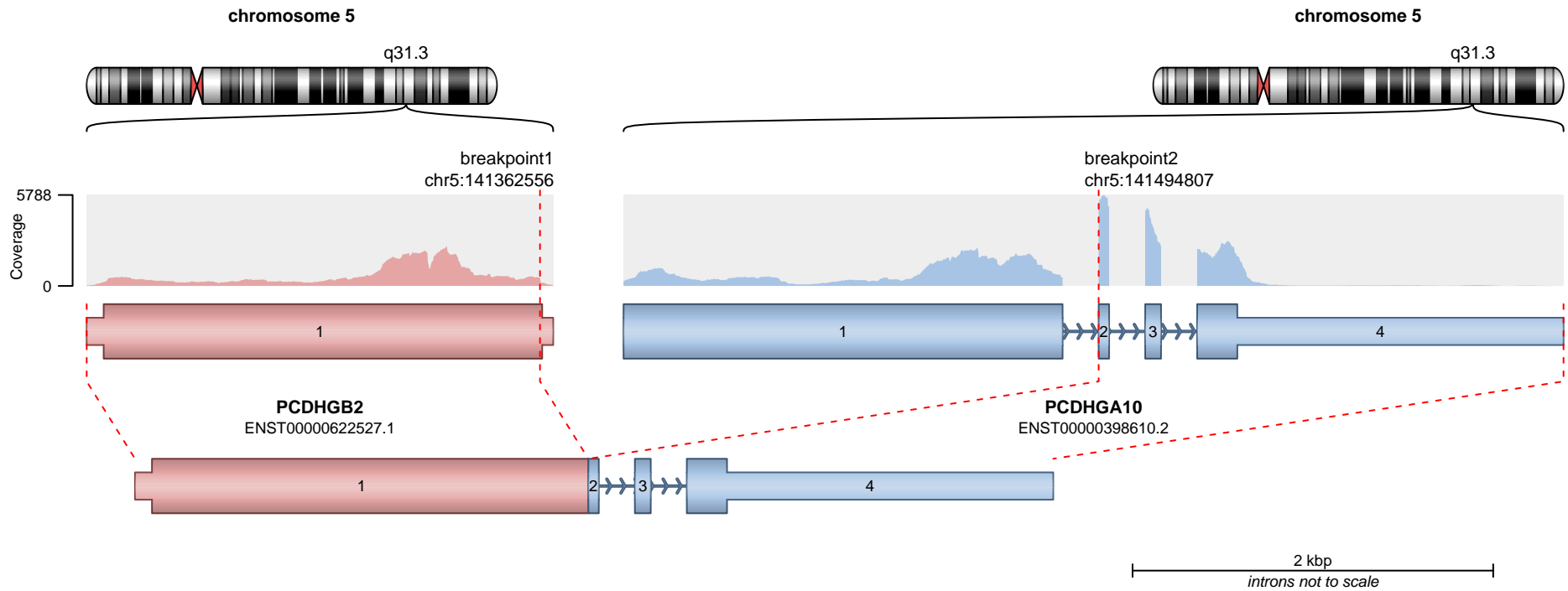

**RETAINED PROTEIN DOMAINS**  
reading frame unclear

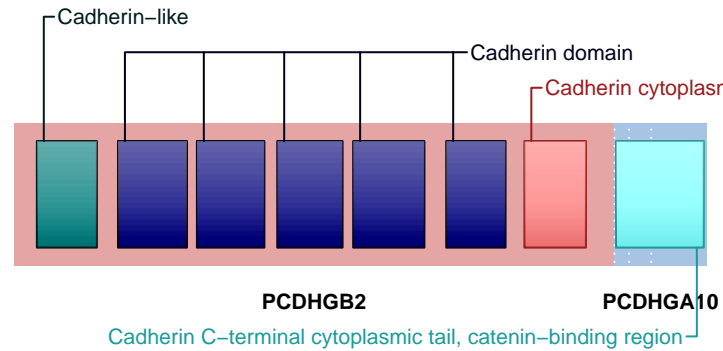

**SUPPORTING READ COUNT**

Split reads = 95  
Discordant mates = 1

— translocation — deletion  
— duplication — inversion

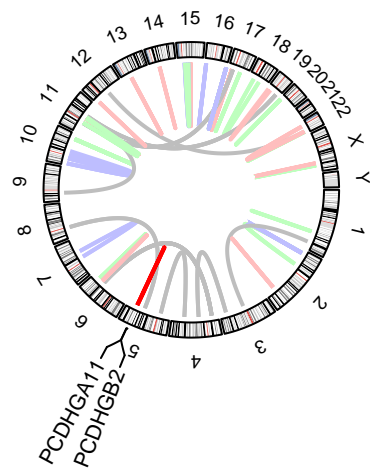
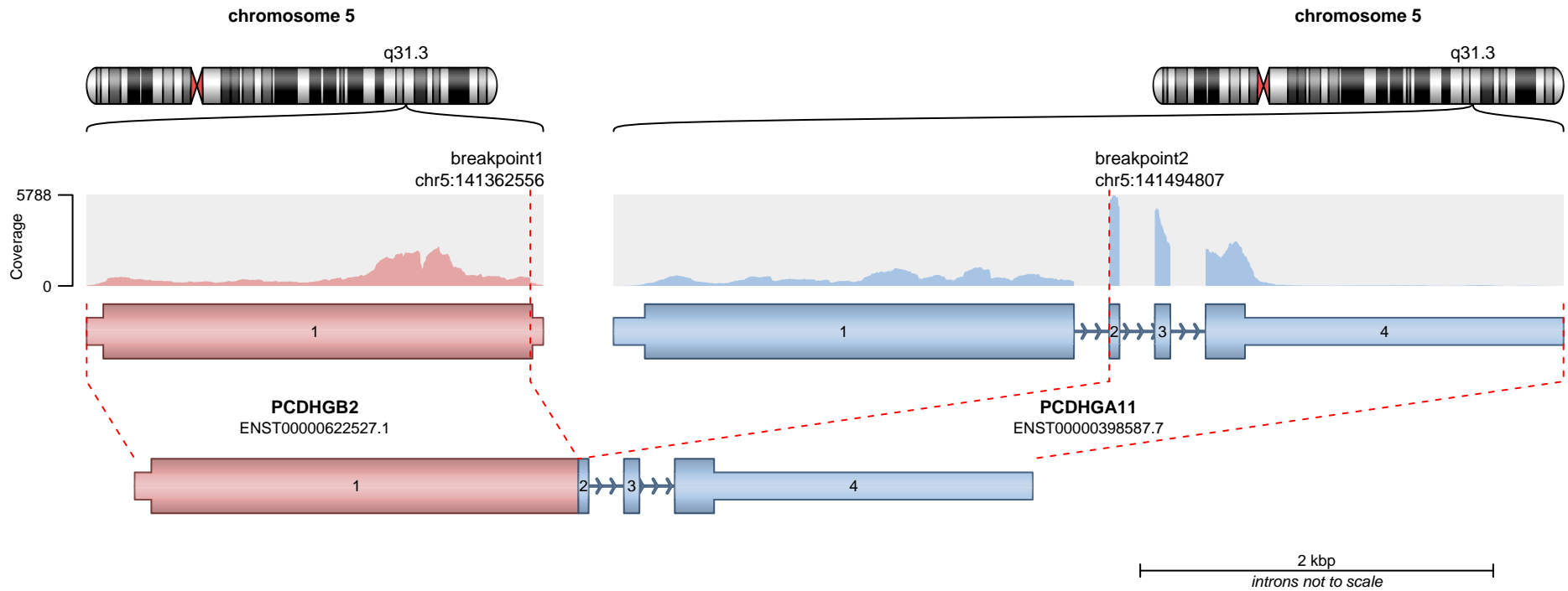

— translocation — deletion  
— duplication — inversion

**RETAINED PROTEIN DOMAINS**  
reading frame unclear

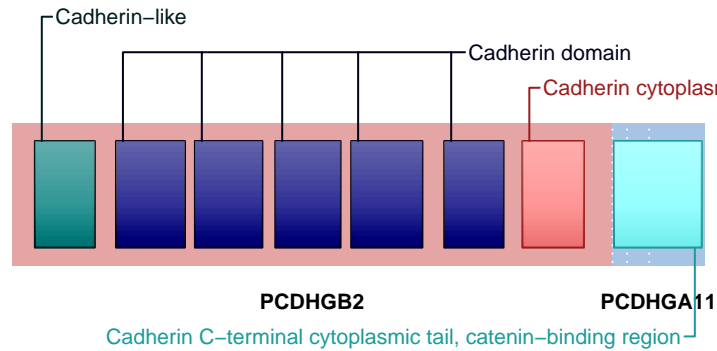

**SUPPORTING READ COUNT**

Split reads = 95  
Discordant mates = 1

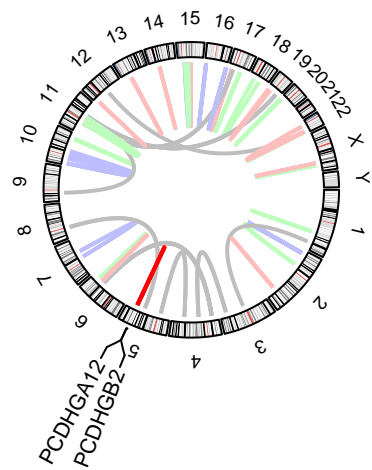
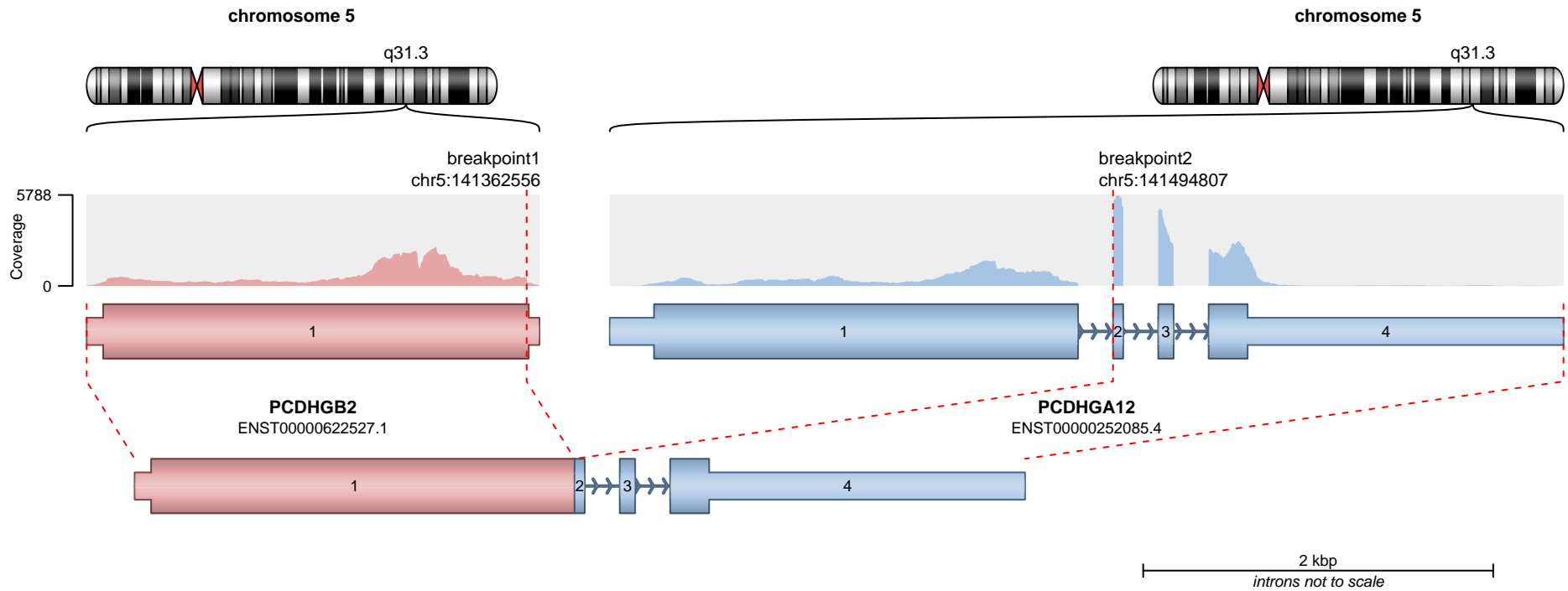

— translocation — deletion  
— duplication — inversion

### RETAINED PROTEIN DOMAINS

reading frame unclear

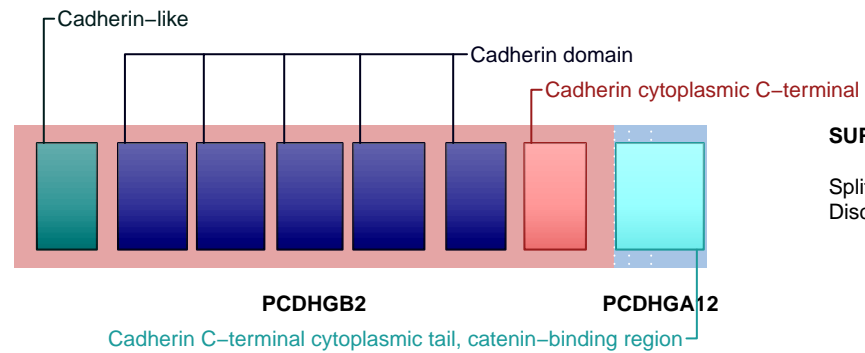

### SUPPORTING READ COUNT

Split reads = 95  
Discordant mates = 1

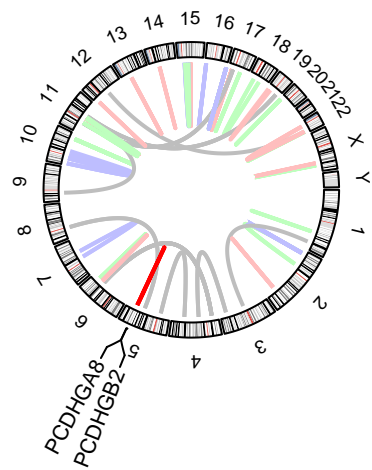
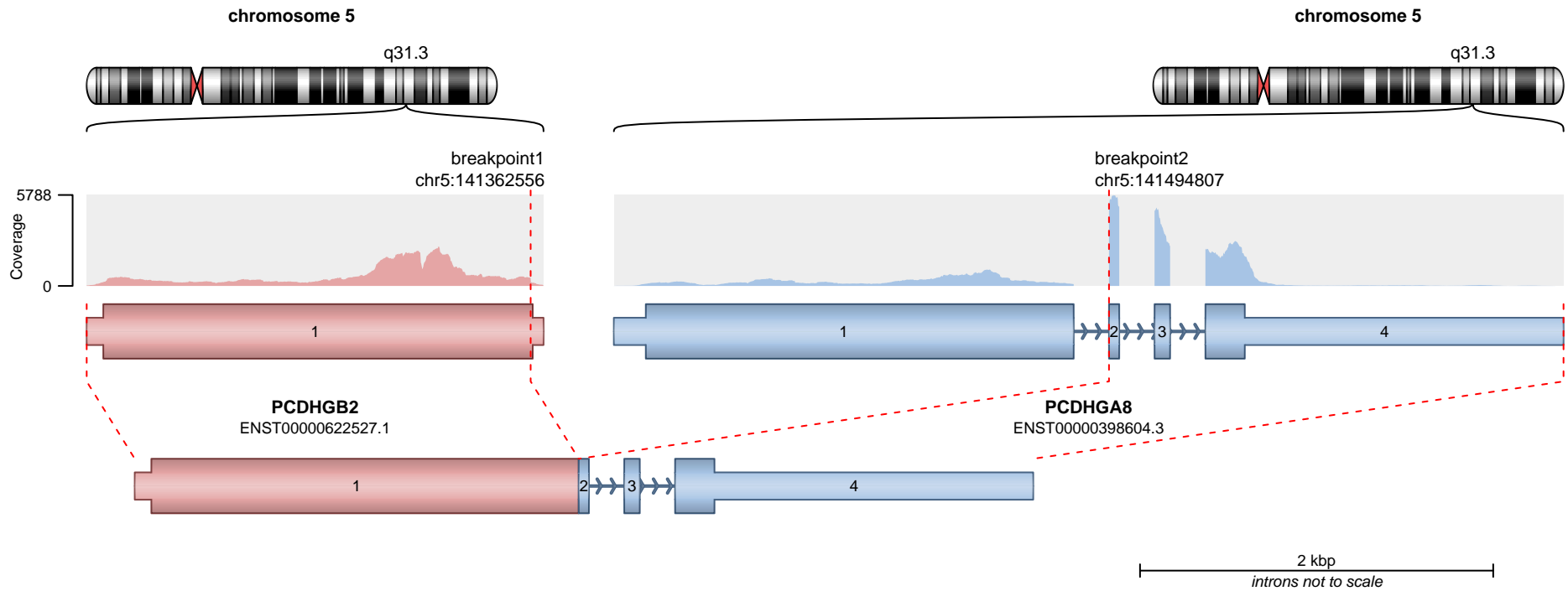

**RETAINED PROTEIN DOMAINS**  
reading frame unclear

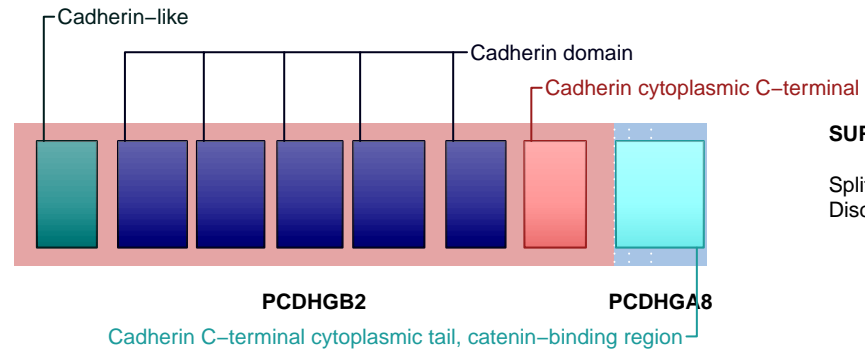

**SUPPORTING READ COUNT**

Split reads = 95  
Discordant mates = 1

— translocation — deletion  
— duplication — inversion

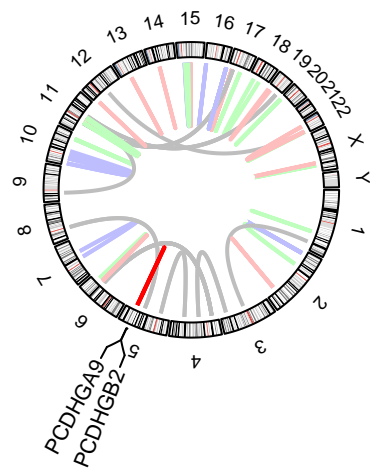
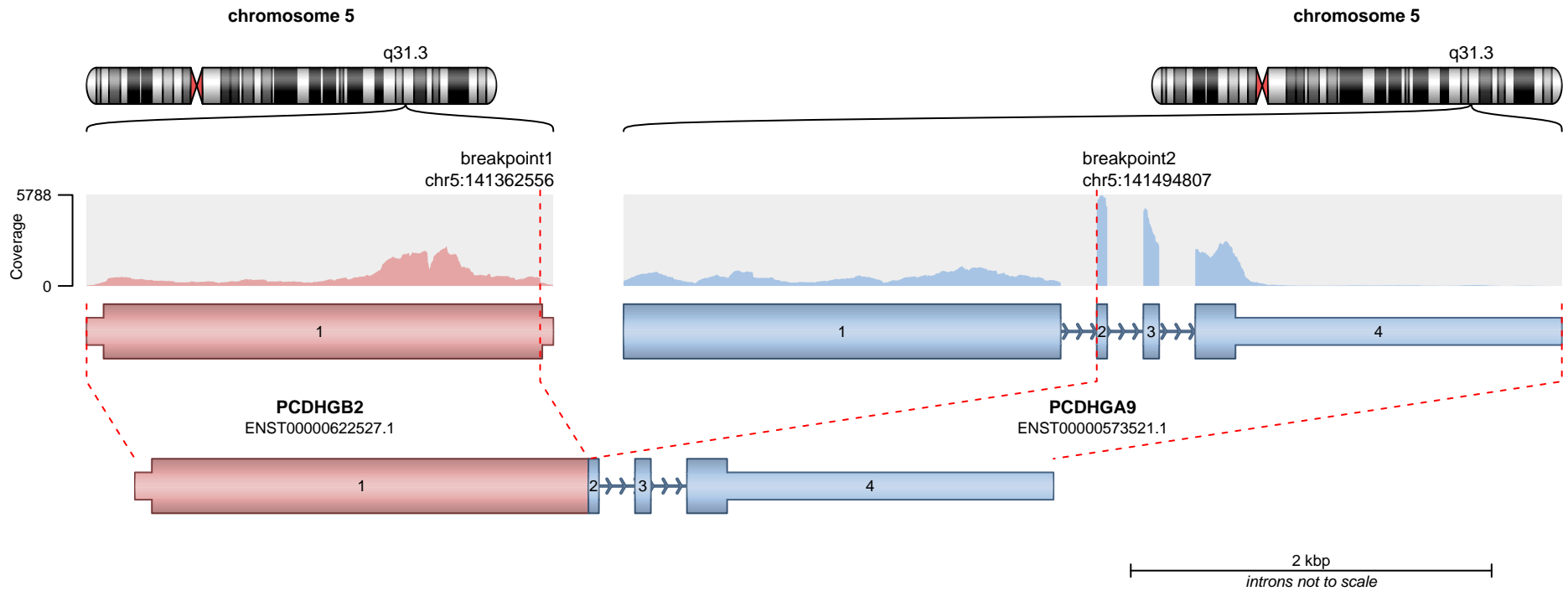

**RETAINED PROTEIN DOMAINS**  
reading frame unclear

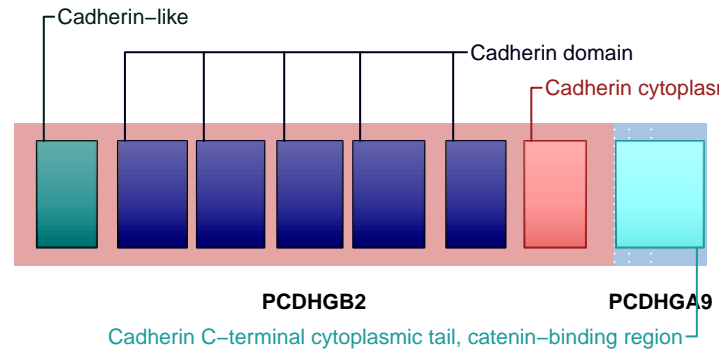

**SUPPORTING READ COUNT**

Split reads = 95  
Discordant mates = 1

— translocation — deletion  
— duplication — inversion

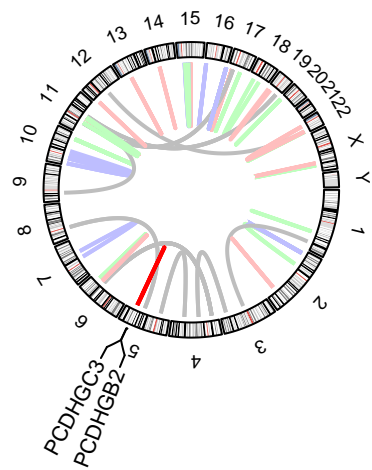
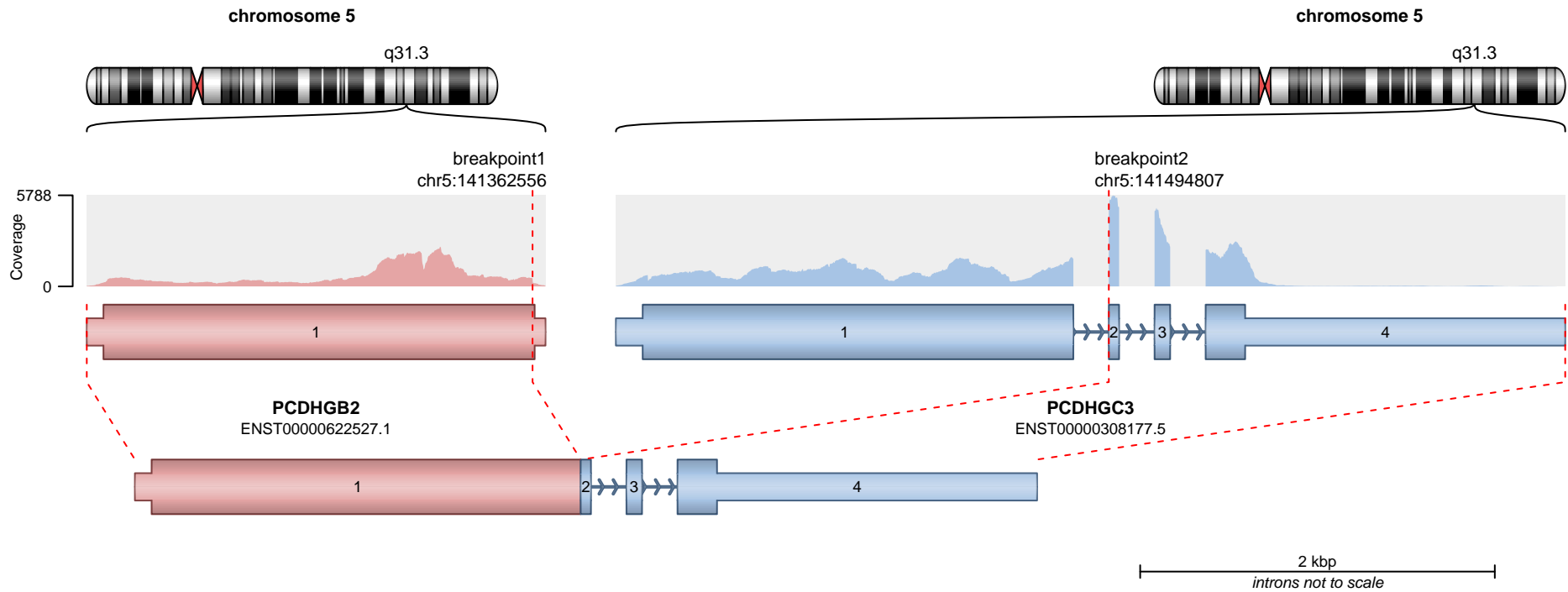

— translocation — deletion  
— duplication — inversion

**RETAINED PROTEIN DOMAINS**  
reading frame unclear

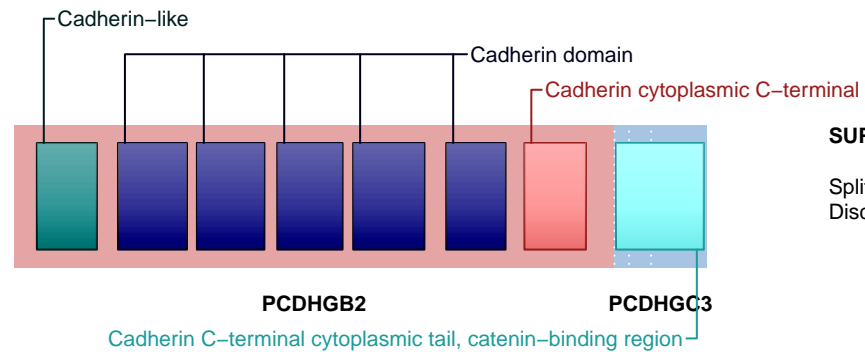

**SUPPORTING READ COUNT**

Split reads = 95  
Discordant mates = 1

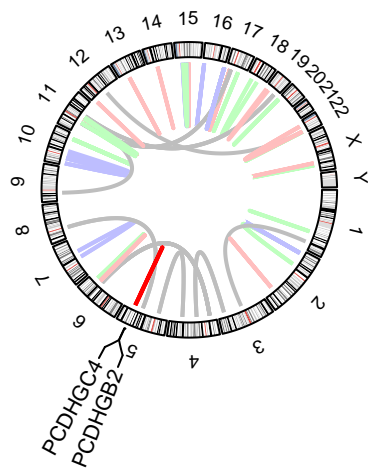
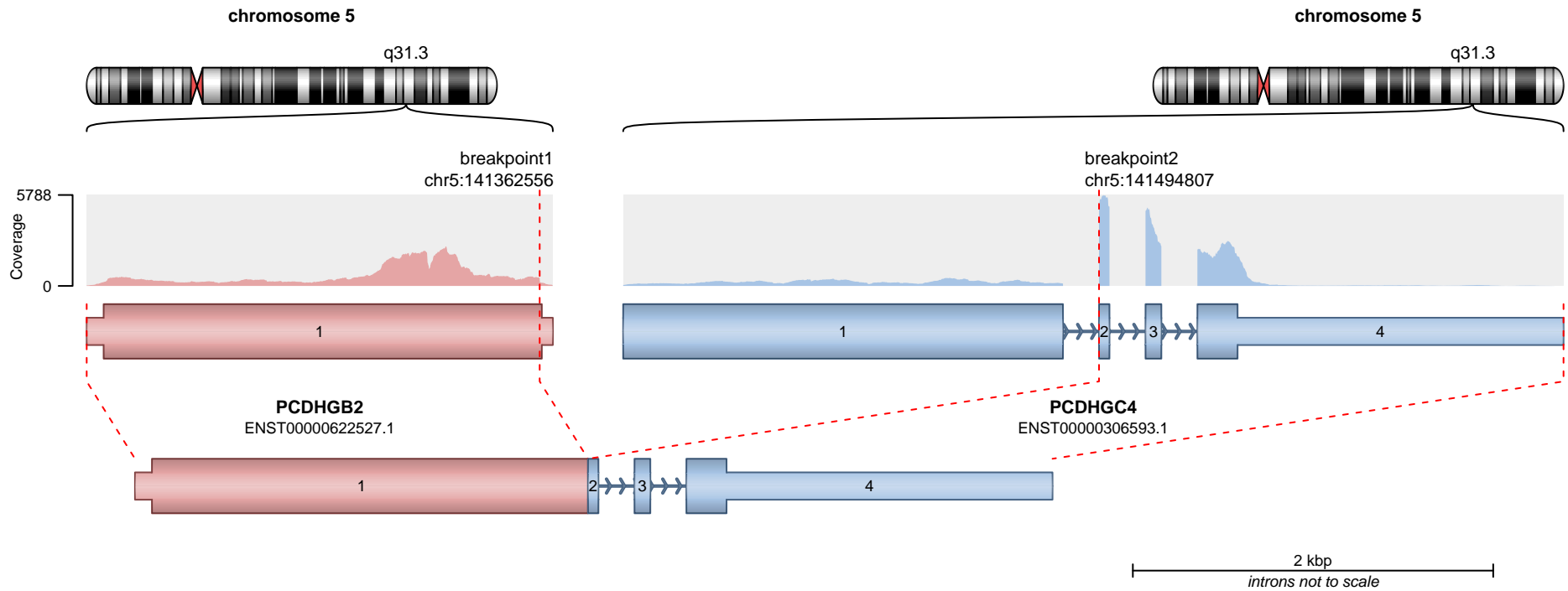

**RETAINED PROTEIN DOMAINS**  
reading frame unclear

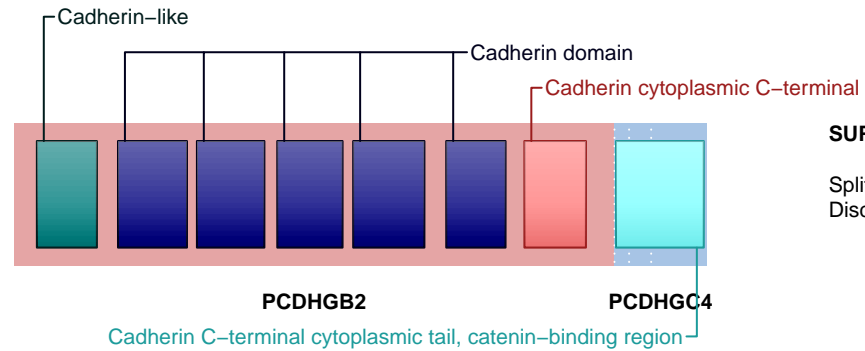

**SUPPORTING READ COUNT**

Split reads = 95  
Discordant mates = 1

— translocation — deletion  
— duplication — inversion

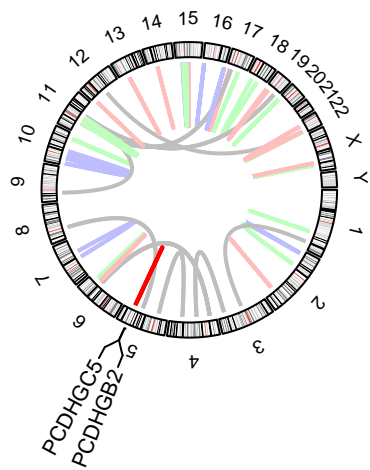
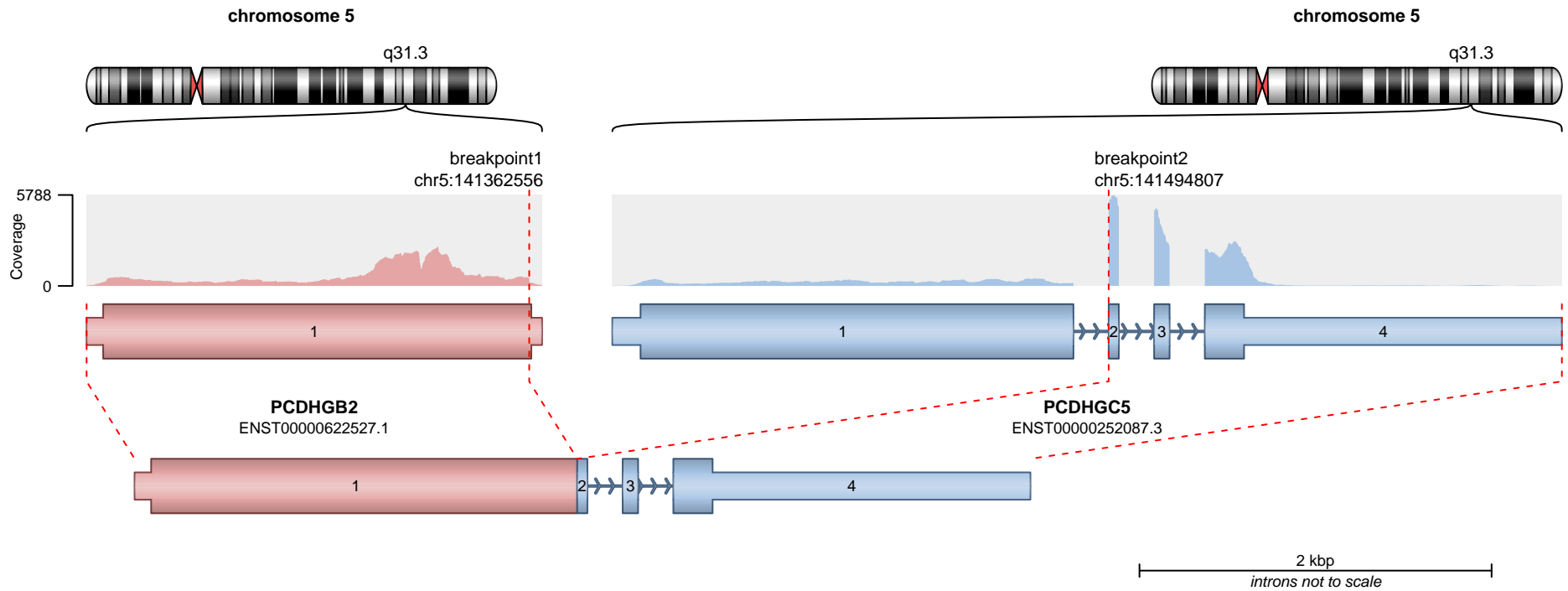

— translocation    — deletion  
 — duplication    — inversion

**RETAINED PROTEIN DOMAINS**  
reading frame unclear

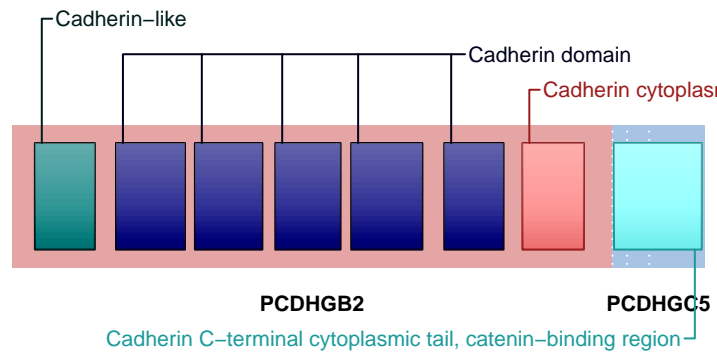

**SUPPORTING READ COUNT**

Split reads = 95  
 Discordant mates = 1

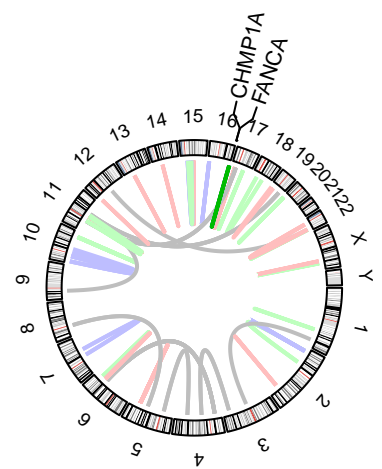
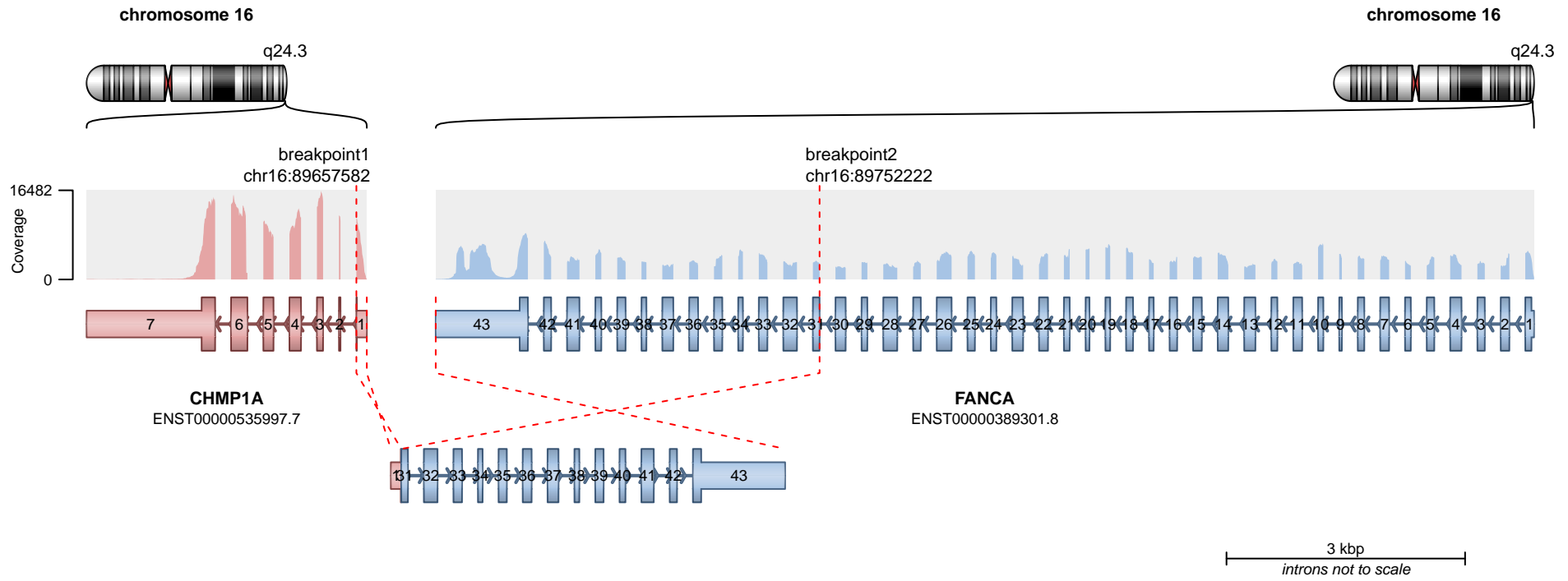

**RETAINED PROTEIN DOMAINS**  
reading frame unclear

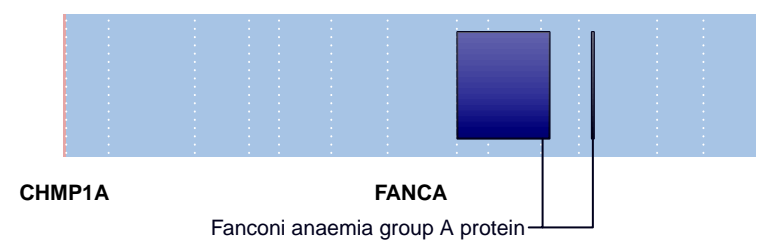

**SUPPORTING READ COUNT**

Split reads = 62  
Discordant mates = 0

- translocation
- duplication
- deletion
- inversion

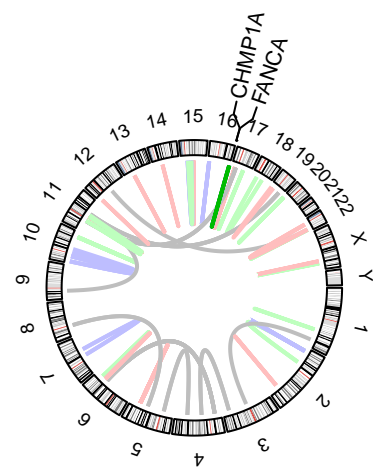
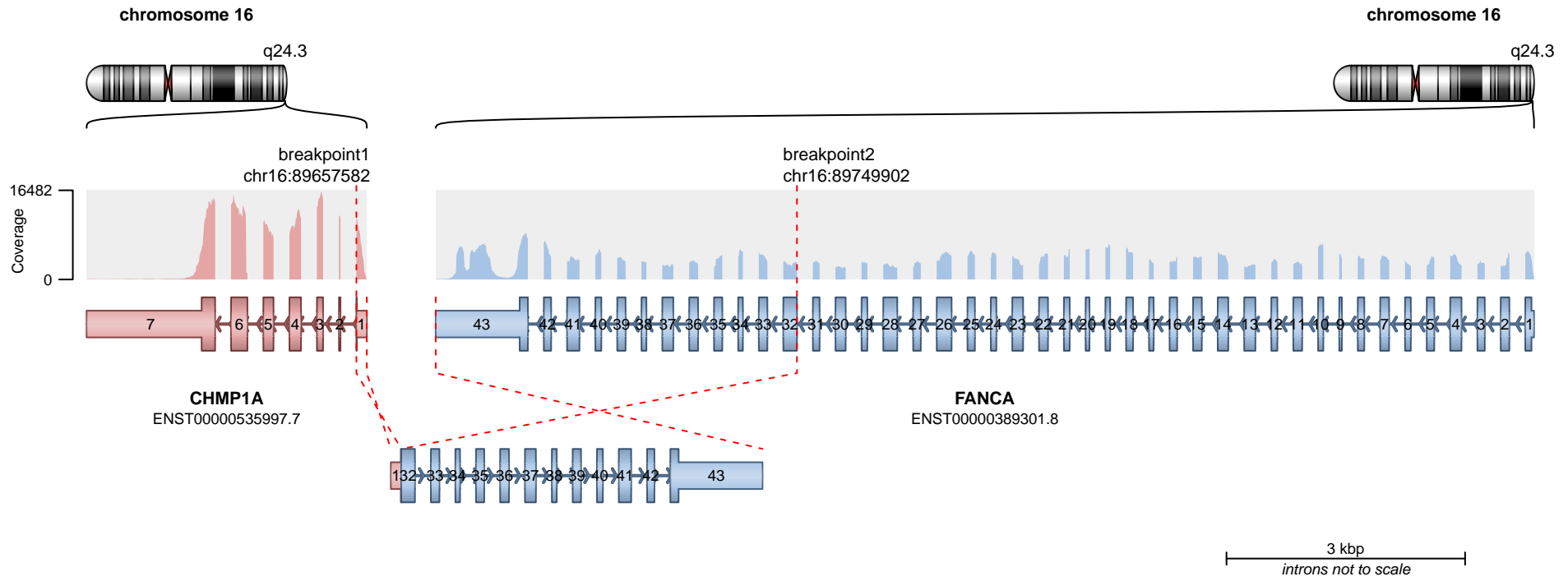

**RETAINED PROTEIN DOMAINS**  
reading frame unclear

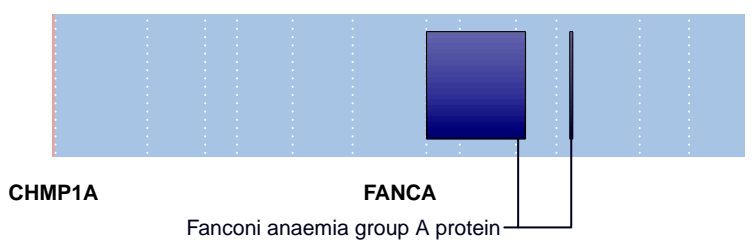

**SUPPORTING READ COUNT**

Split reads = 11  
Discordant mates = 0

- translocation
- duplication
- deletion
- inversion

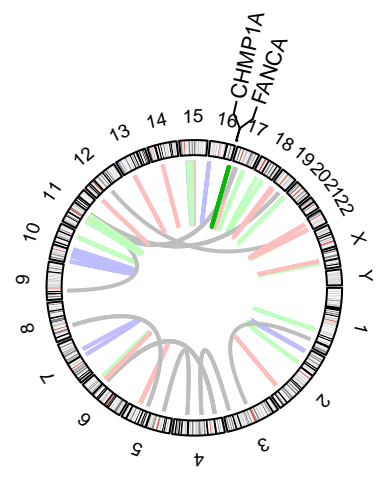
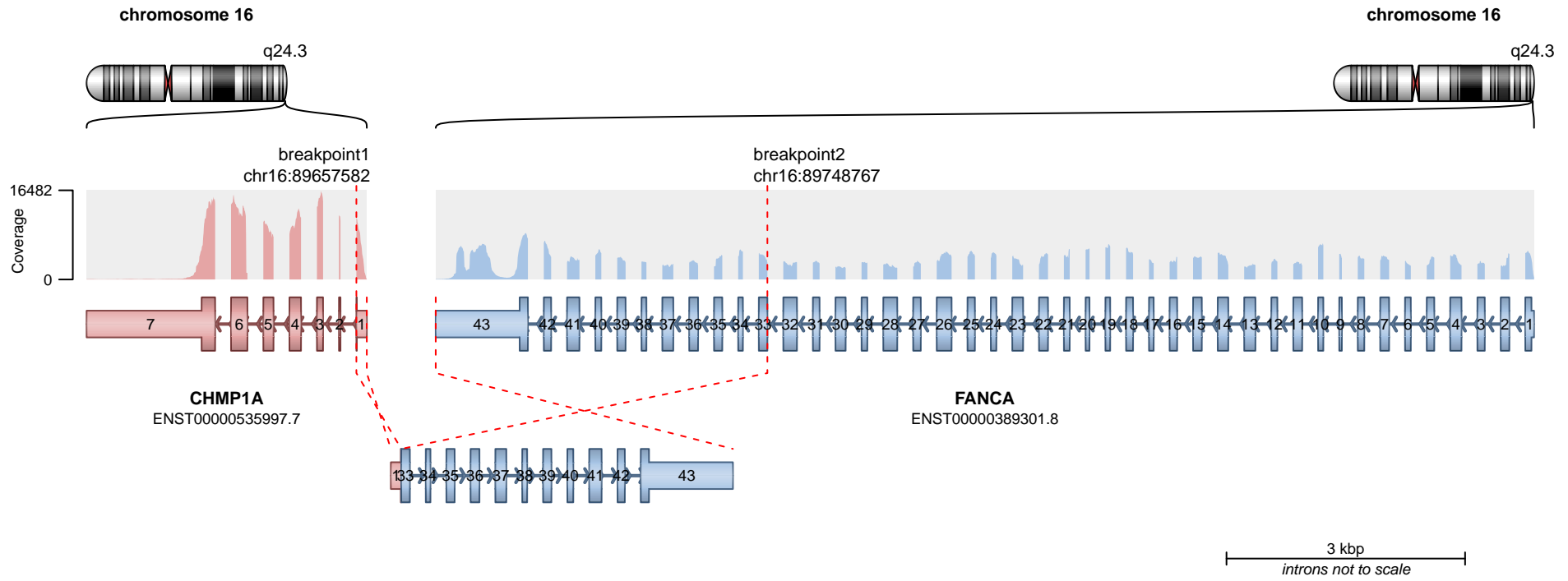

**RETAINED PROTEIN DOMAINS**  
reading frame unclear

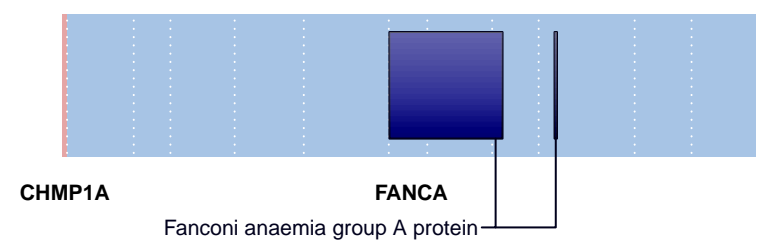

**SUPPORTING READ COUNT**

Split reads = 2  
Discordant mates = 0

- translocation
- duplication
- deletion
- inversion

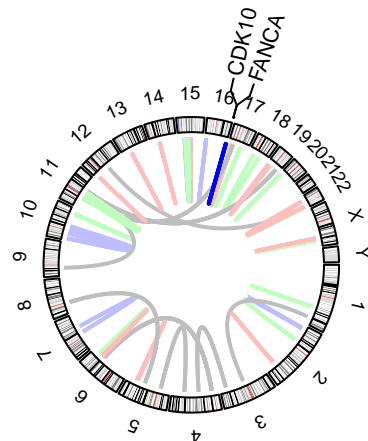
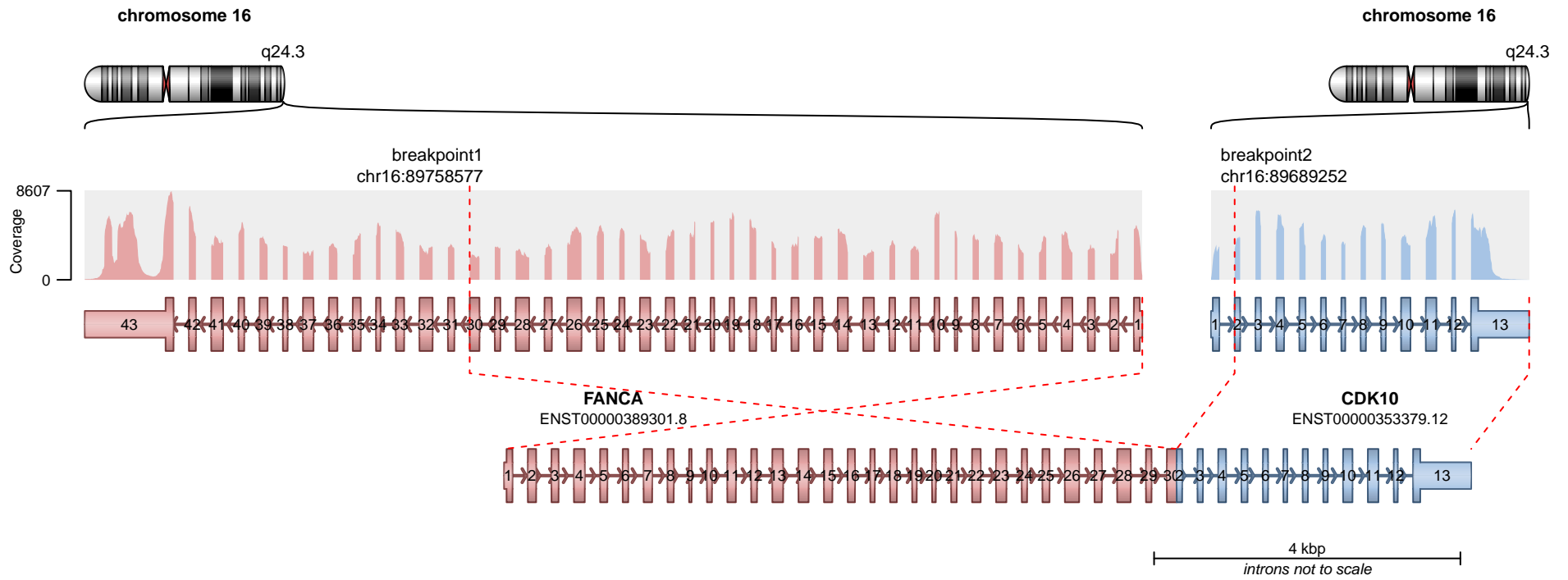

**RETAINED PROTEIN DOMAINS**  
reading frame unclear

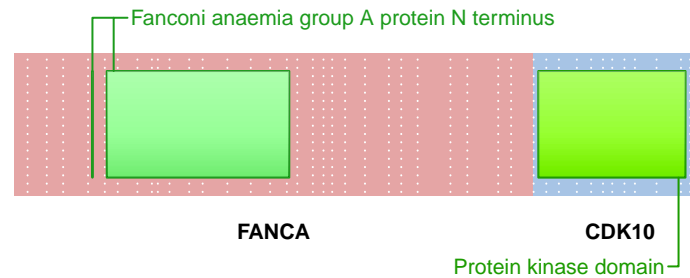

**SUPPORTING READ COUNT**

Split reads = 59  
Discordant mates = 0

- translocation
- duplication
- deletion
- inversion

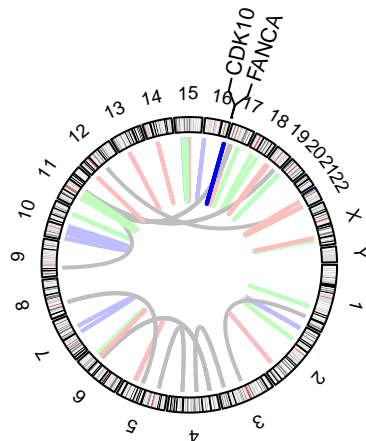
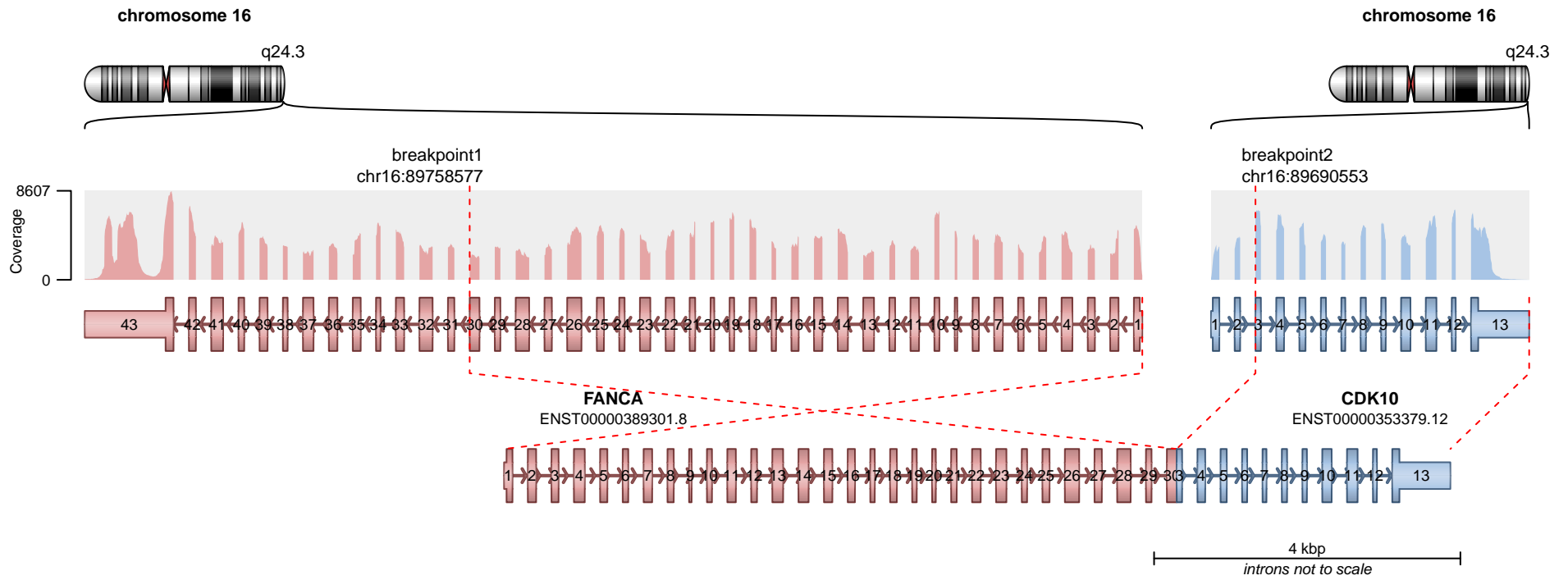

**RETAINED PROTEIN DOMAINS**  
reading frame unclear

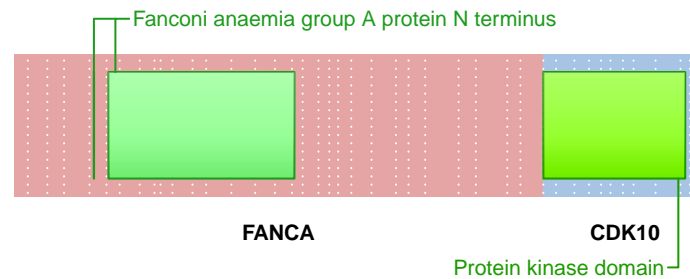

**SUPPORTING READ COUNT**

Split reads = 46  
Discordant mates = 0

- translocation
- duplication
- deletion
- inversion

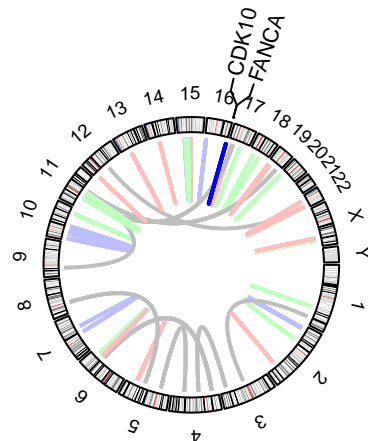
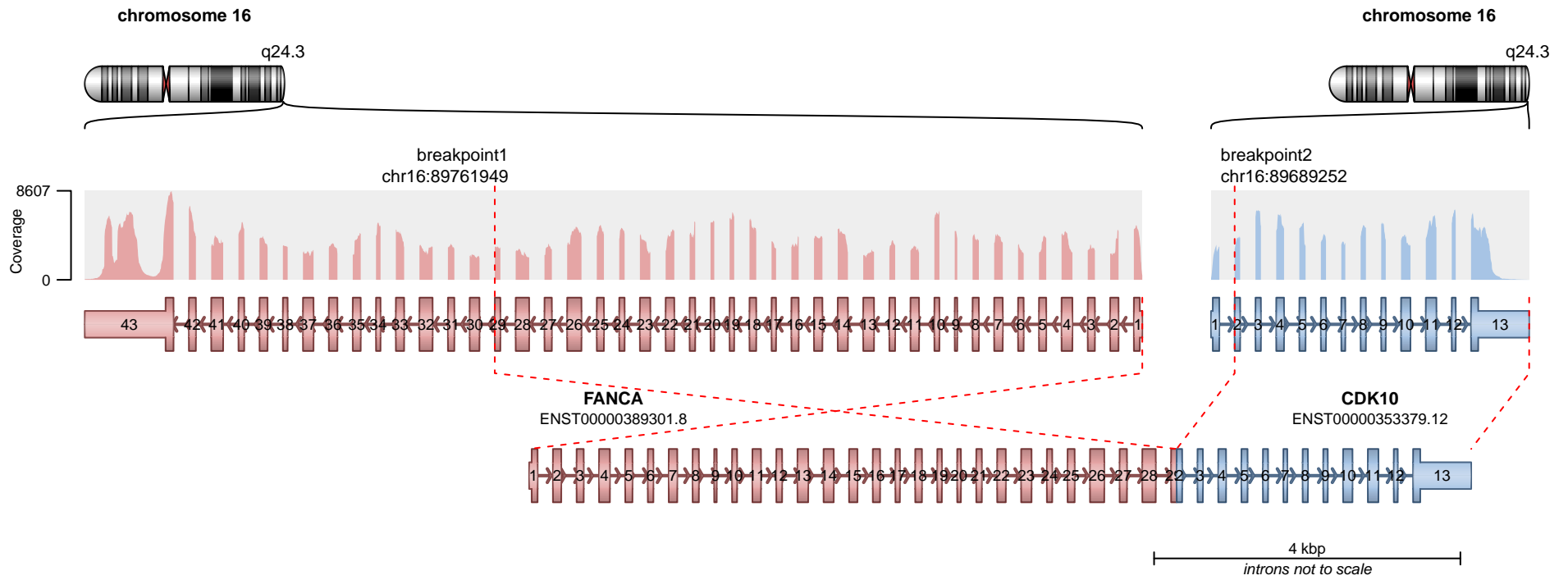

**RETAINED PROTEIN DOMAINS**  
reading frame unclear

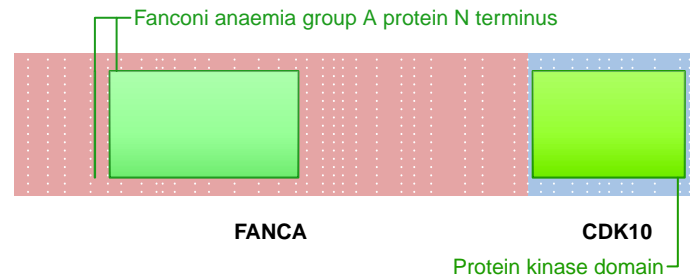

**SUPPORTING READ COUNT**

Split reads = 2  
Discordant mates = 0

- translocation
- duplication
- deletion
- inversion

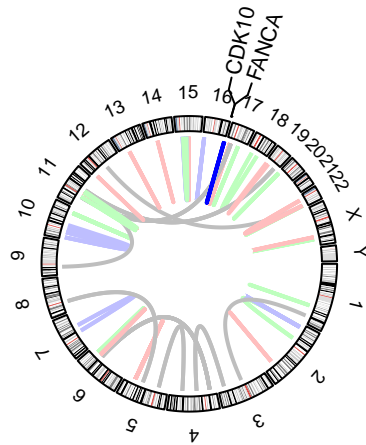
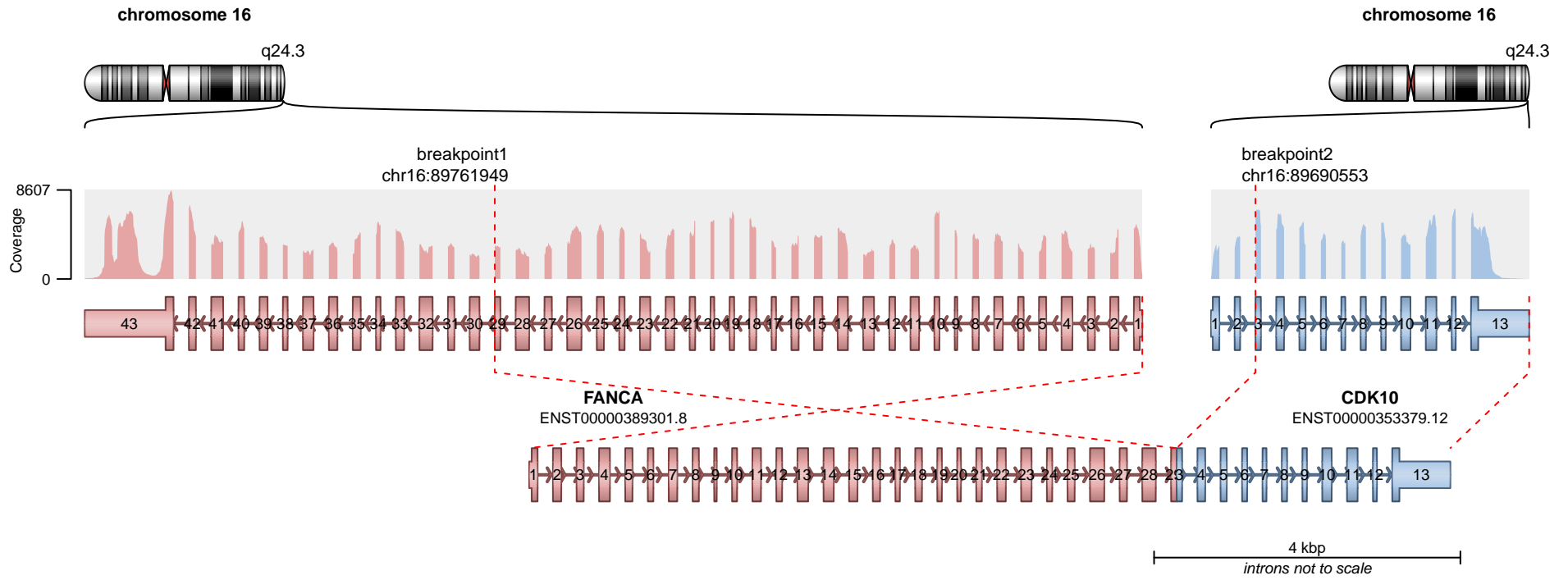

**RETAINED PROTEIN DOMAINS**  
reading frame unclear

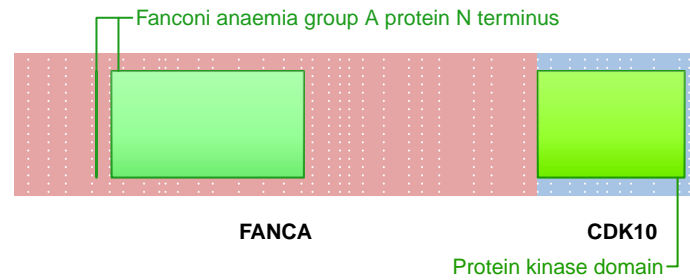

**SUPPORTING READ COUNT**

Split reads = 2  
Discordant mates = 0

- translocation
- duplication
- deletion
- inversion

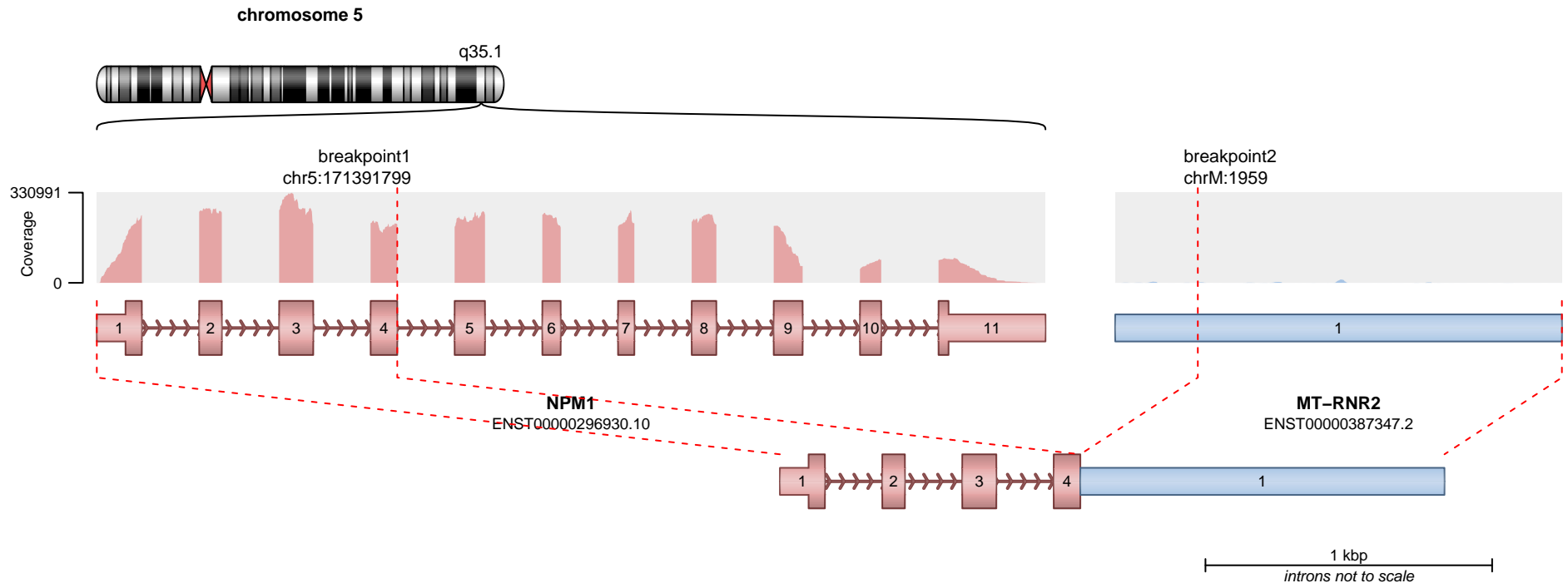

**RETAINED PROTEIN DOMAINS**  
reading frame unclear

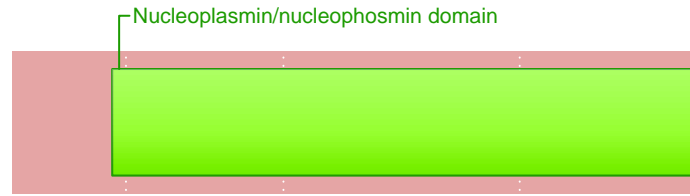

**NPM1**

**SUPPORTING READ COUNT**

Split reads = 56  
Discordant mates = 0

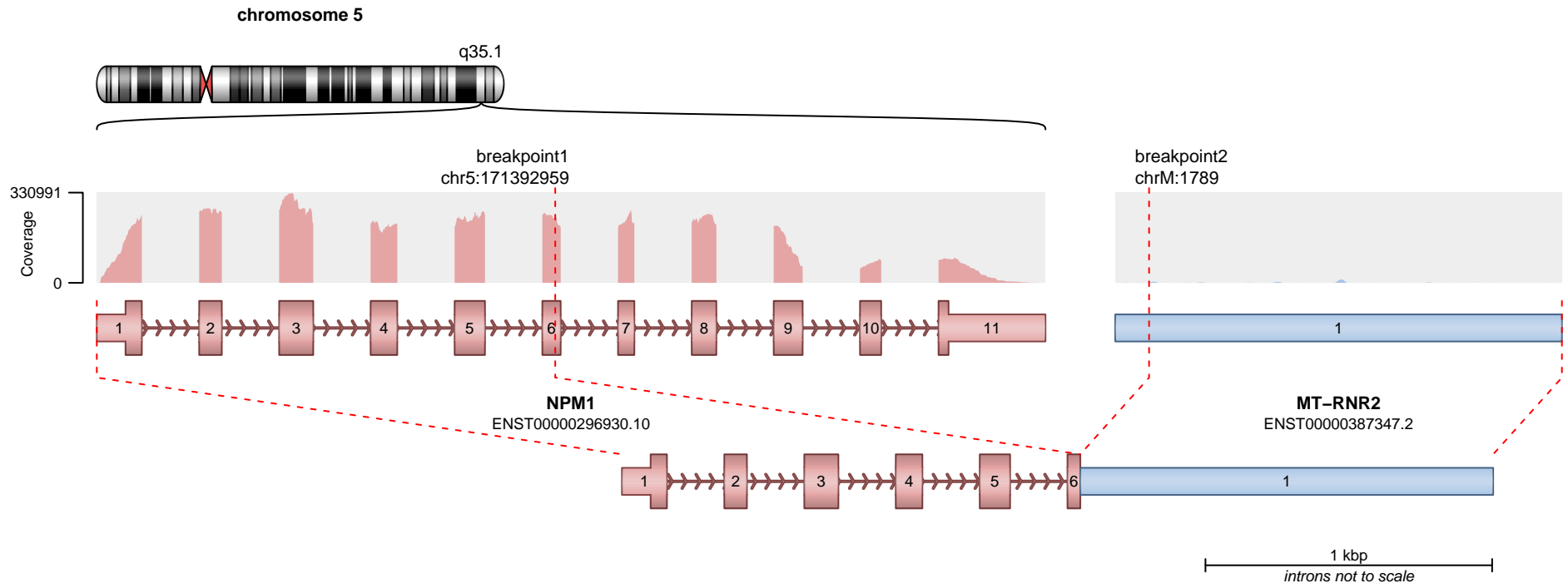

**RETAINED PROTEIN DOMAINS**  
reading frame unclear

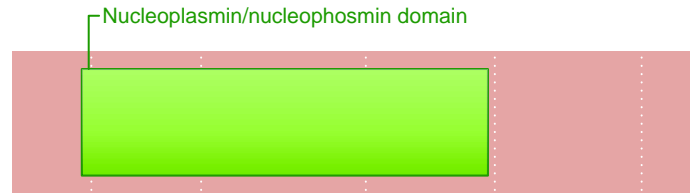

**NPM1**

**SUPPORTING READ COUNT**

Split reads = 10  
Discordant mates = 0

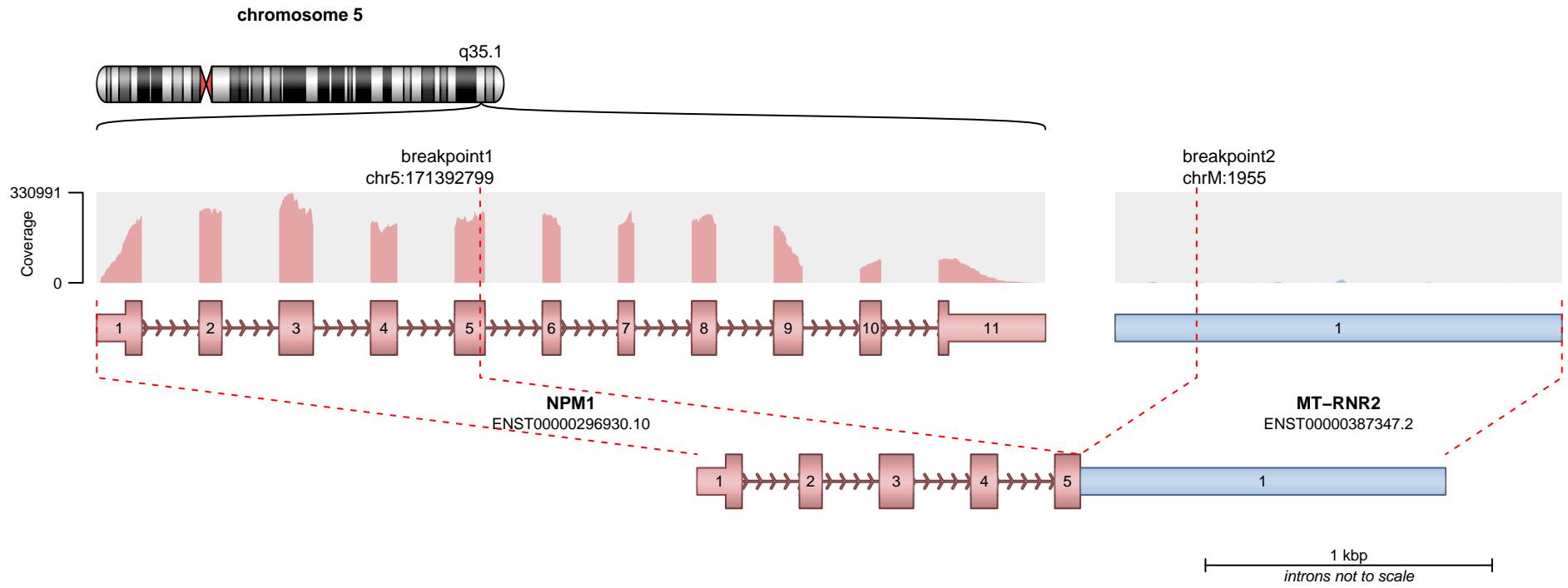

**RETAINED PROTEIN DOMAINS**  
reading frame unclear

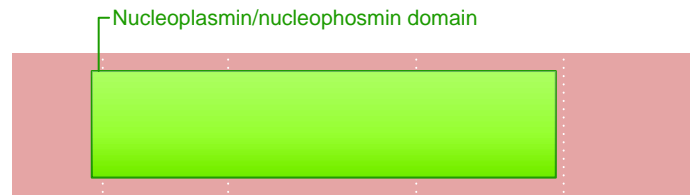

**NPM1**

**SUPPORTING READ COUNT**

Split reads = 7  
Discordant mates = 0

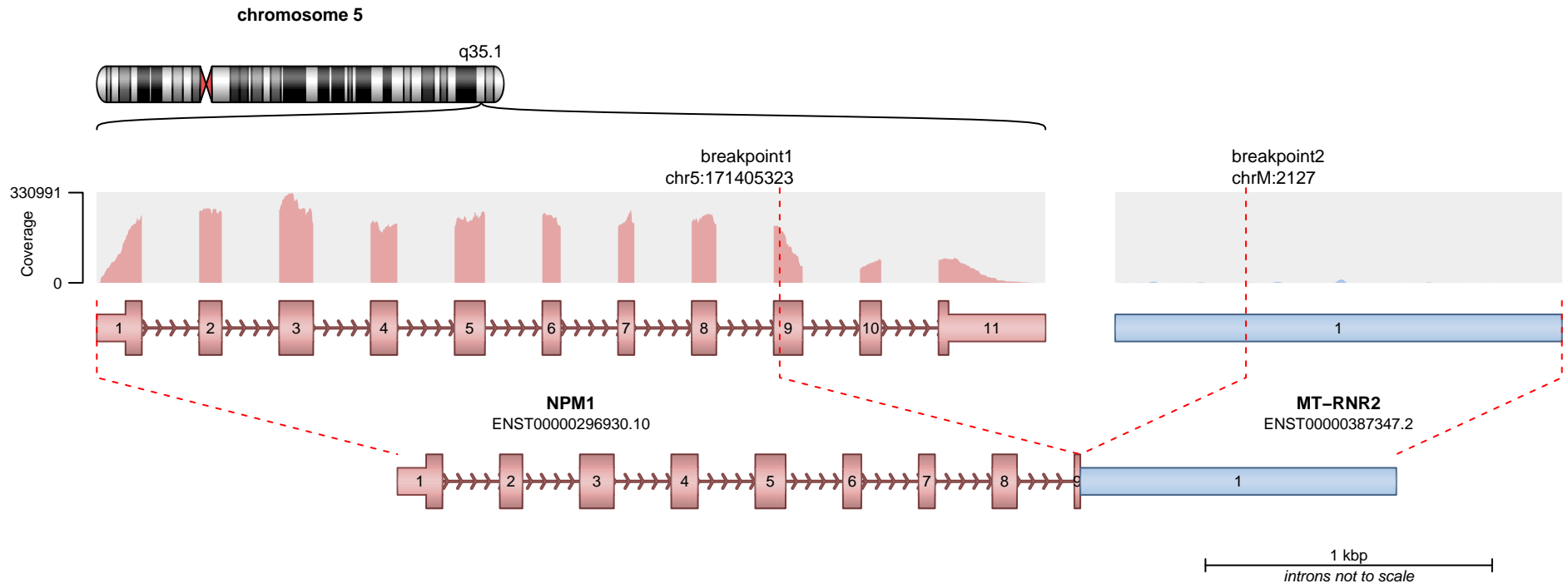

**RETAINED PROTEIN DOMAINS**  
reading frame unclear

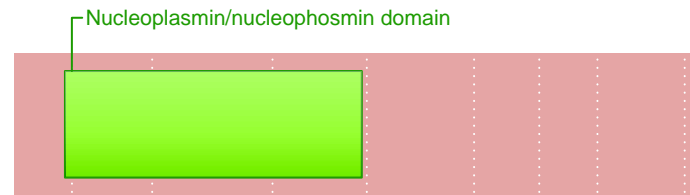

**NPM1**

**SUPPORTING READ COUNT**

Split reads = 5  
Discordant mates = 0

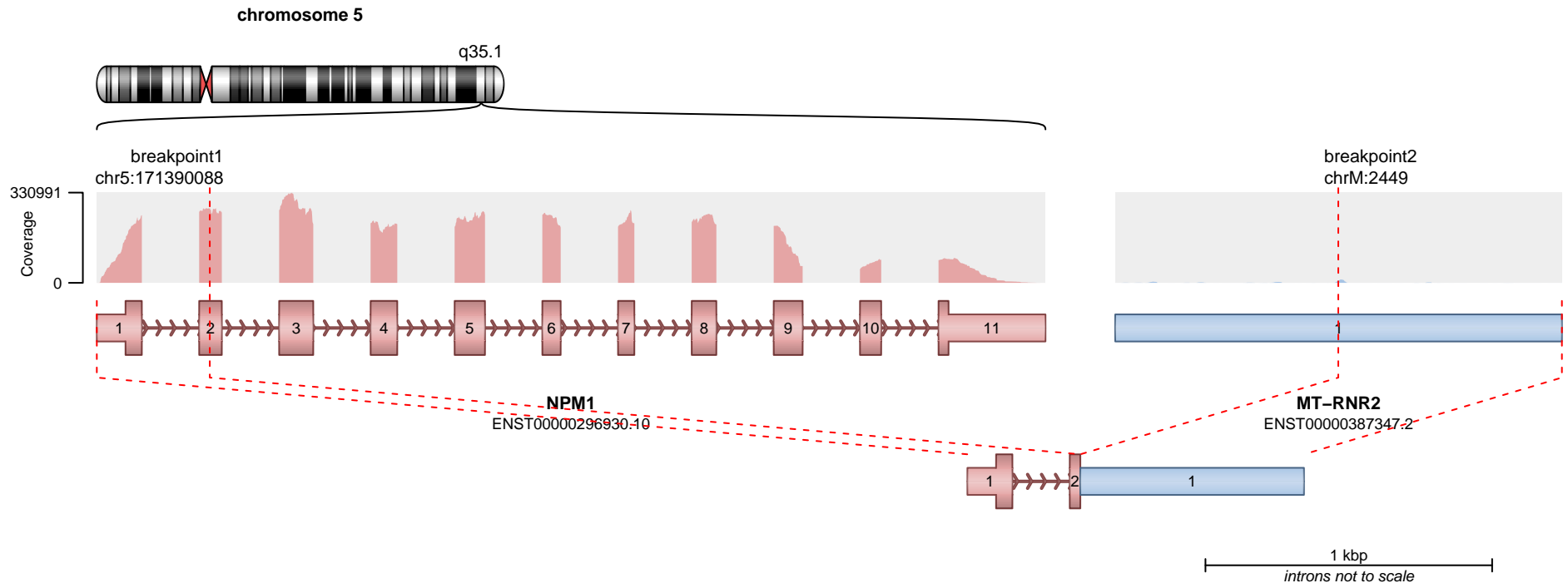

**RETAINED PROTEIN DOMAINS**  
reading frame unclear

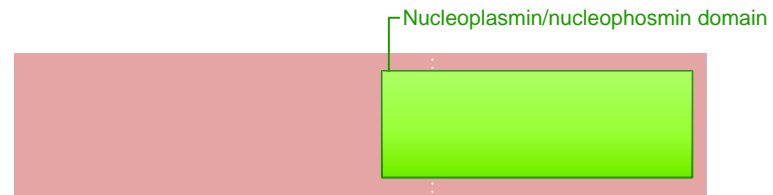

**NPM1**

**SUPPORTING READ COUNT**

Split reads = 4  
Discordant mates = 0

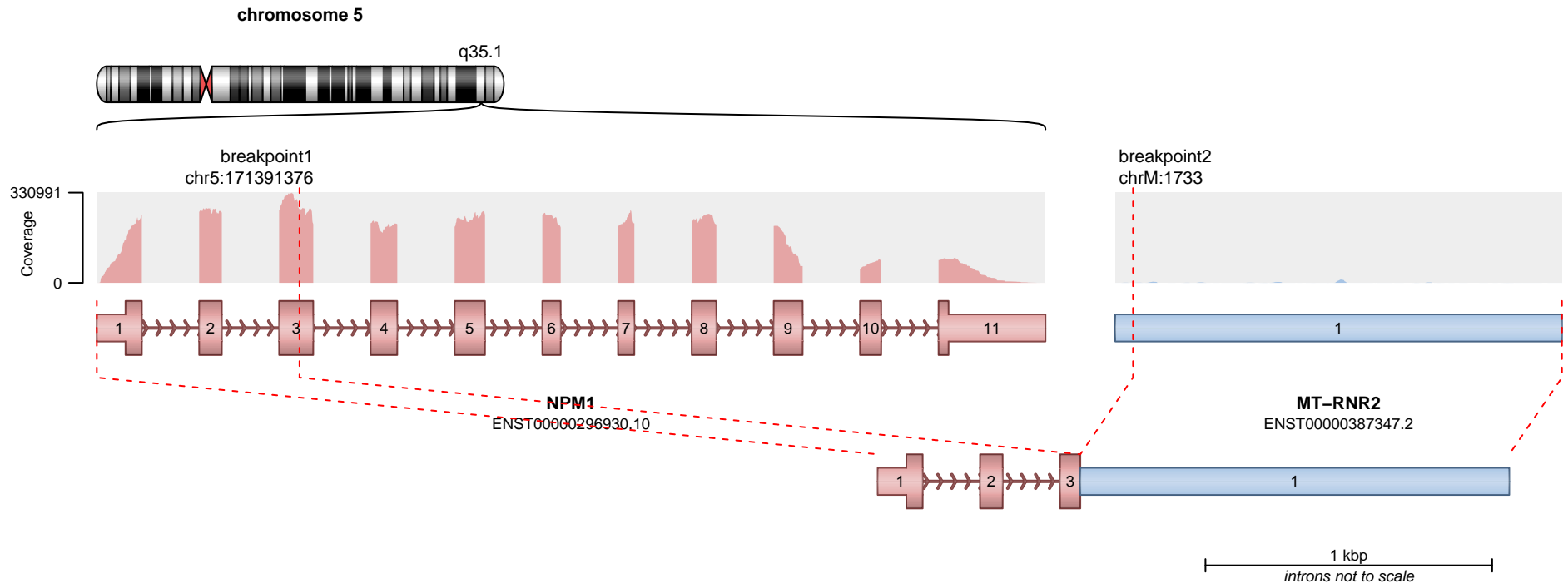

**RETAINED PROTEIN DOMAINS**  
reading frame unclear

Nucleoplasmin/nucleophosmin domain



**NPM1**

**SUPPORTING READ COUNT**

Split reads = 3  
Discordant mates = 0

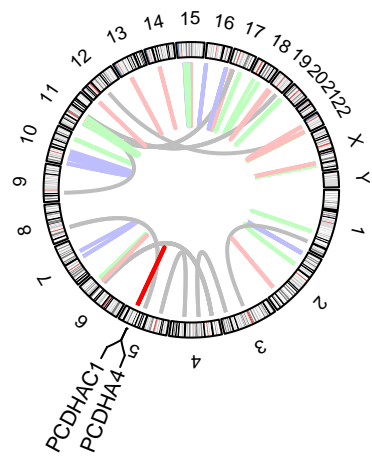
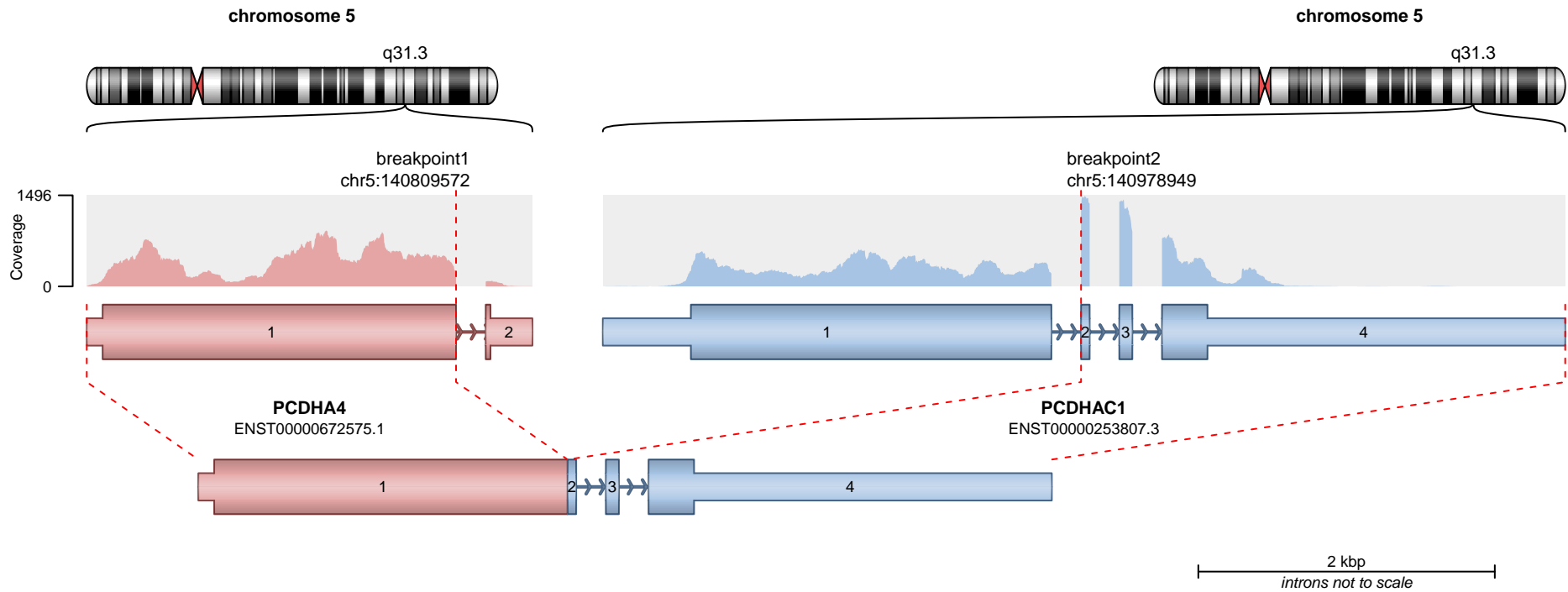

**RETAINED PROTEIN DOMAINS**  
reading frame unclear

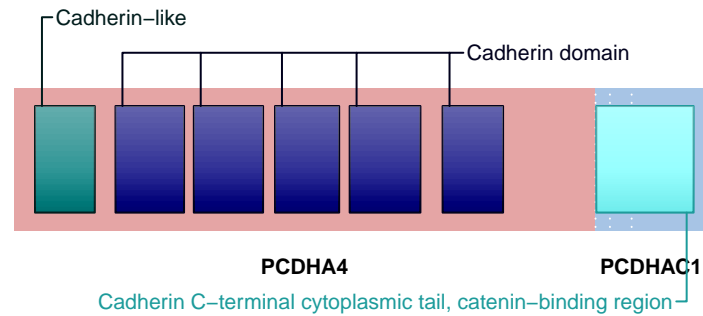

**SUPPORTING READ COUNT**

Split reads = 54  
Discordant mates = 3

— translocation — deletion  
— duplication — inversion

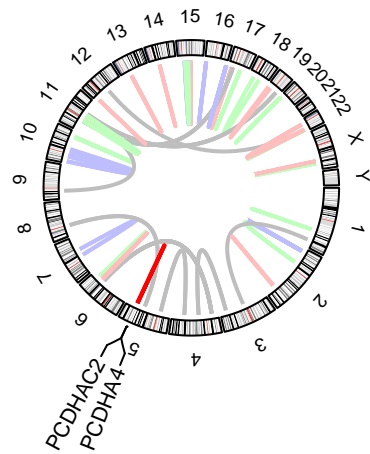
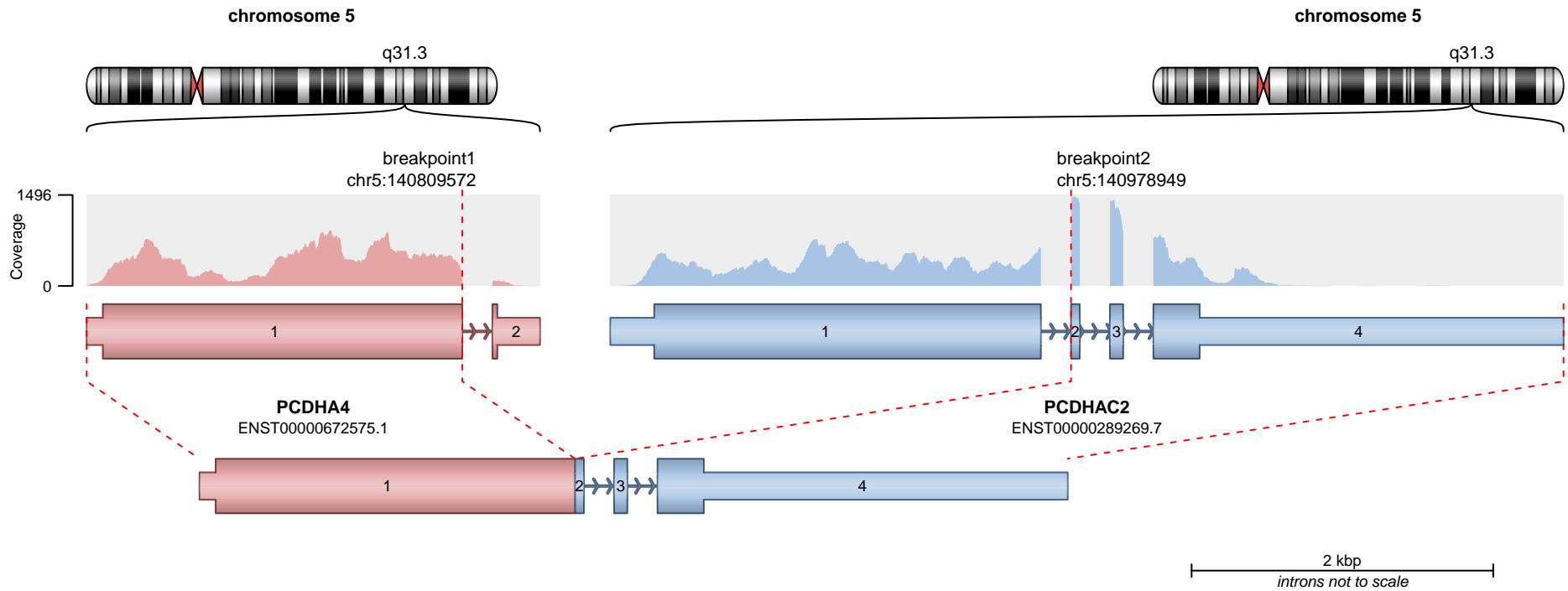

**RETAINED PROTEIN DOMAINS**  
reading frame unclear

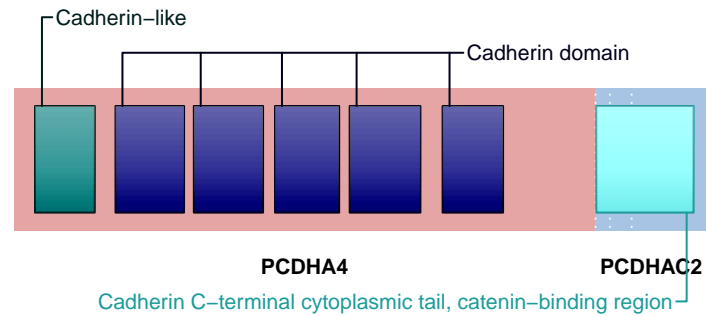

**SUPPORTING READ COUNT**

Split reads = 54  
Discordant mates = 3

— translocation — deletion  
— duplication — inversion

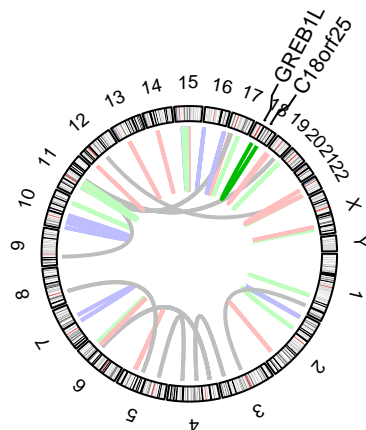
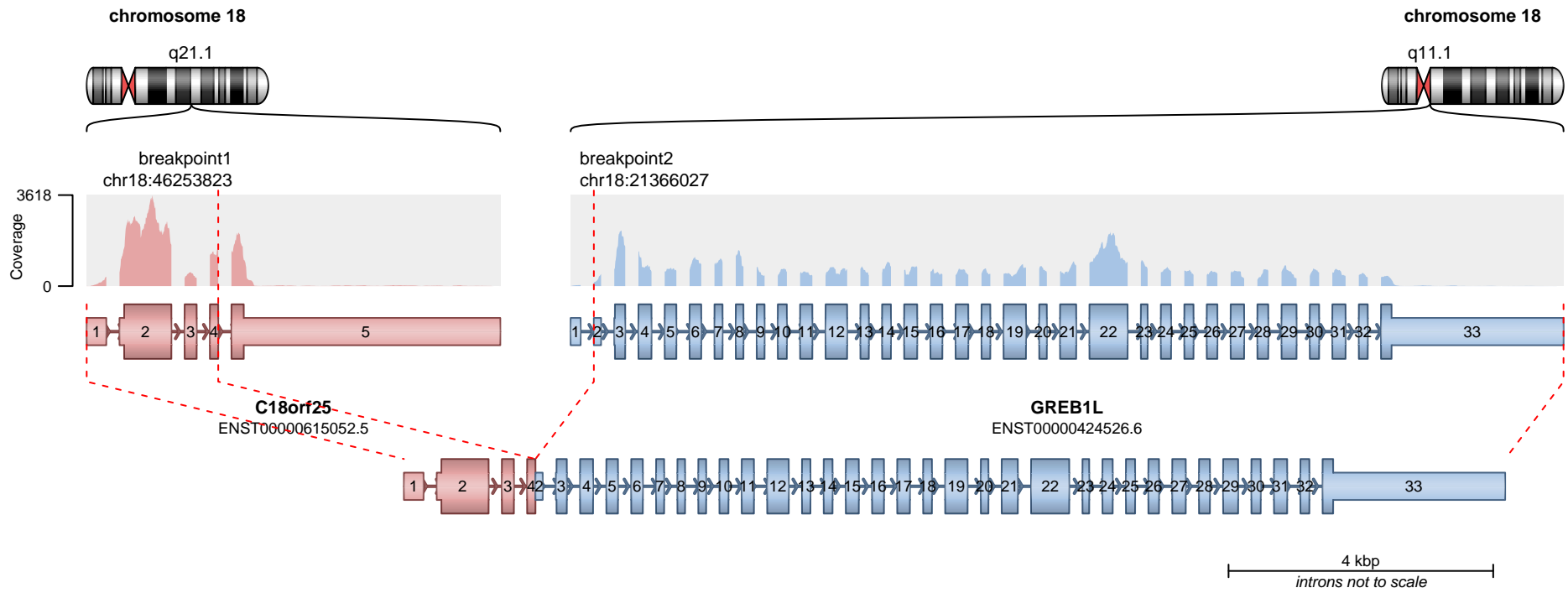

**RETAINED PROTEIN DOMAINS**  
reading frame unclear

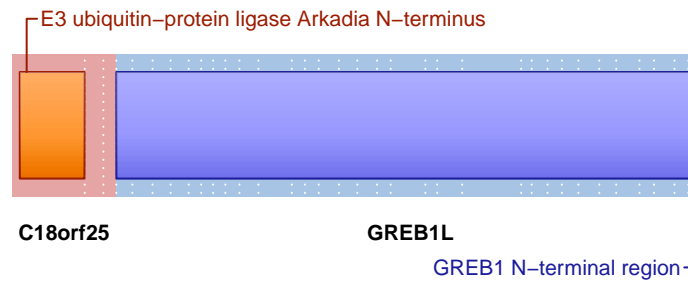

**SUPPORTING READ COUNT**

Split reads = 54  
Discordant mates = 1

— translocation — deletion  
— duplication — inversion

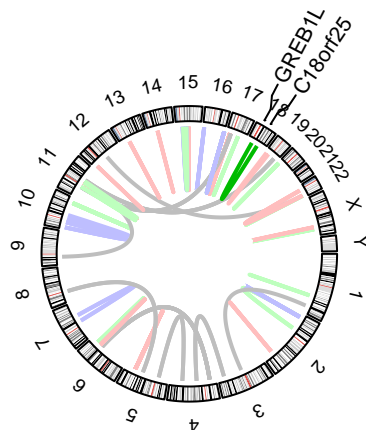
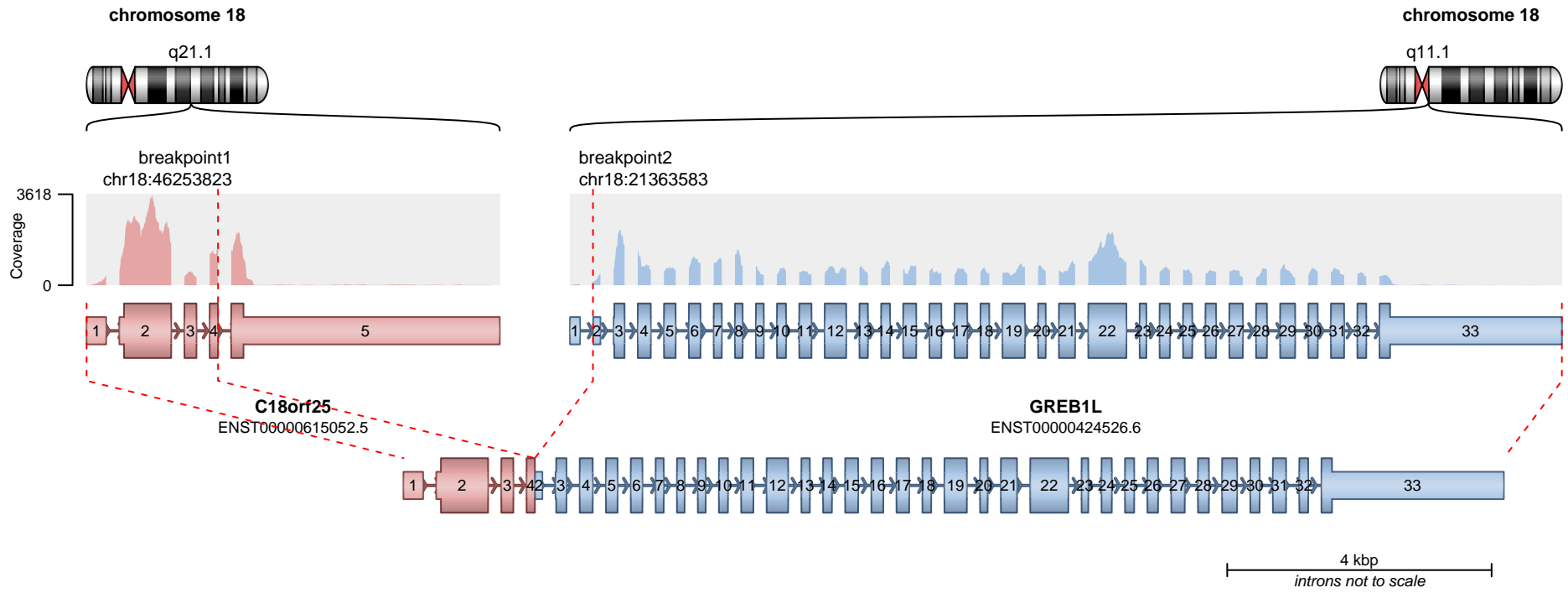

**RETAINED PROTEIN DOMAINS**  
reading frame unclear

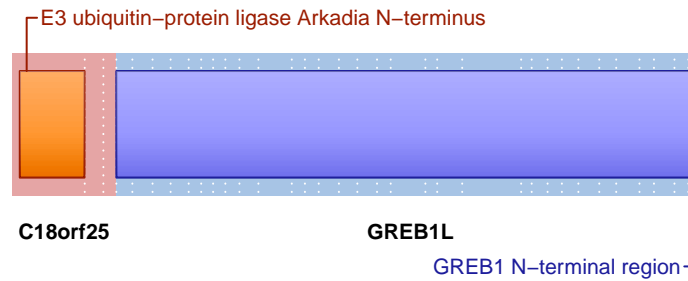

**SUPPORTING READ COUNT**

Split reads = 3  
Discordant mates = 1

— translocation    — deletion  
— duplication    — inversion

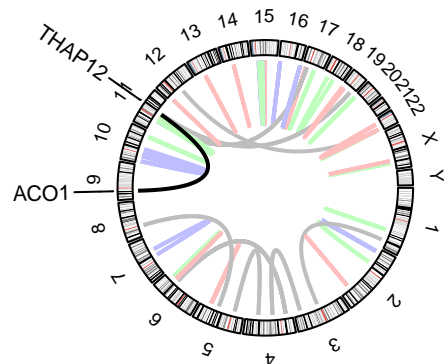
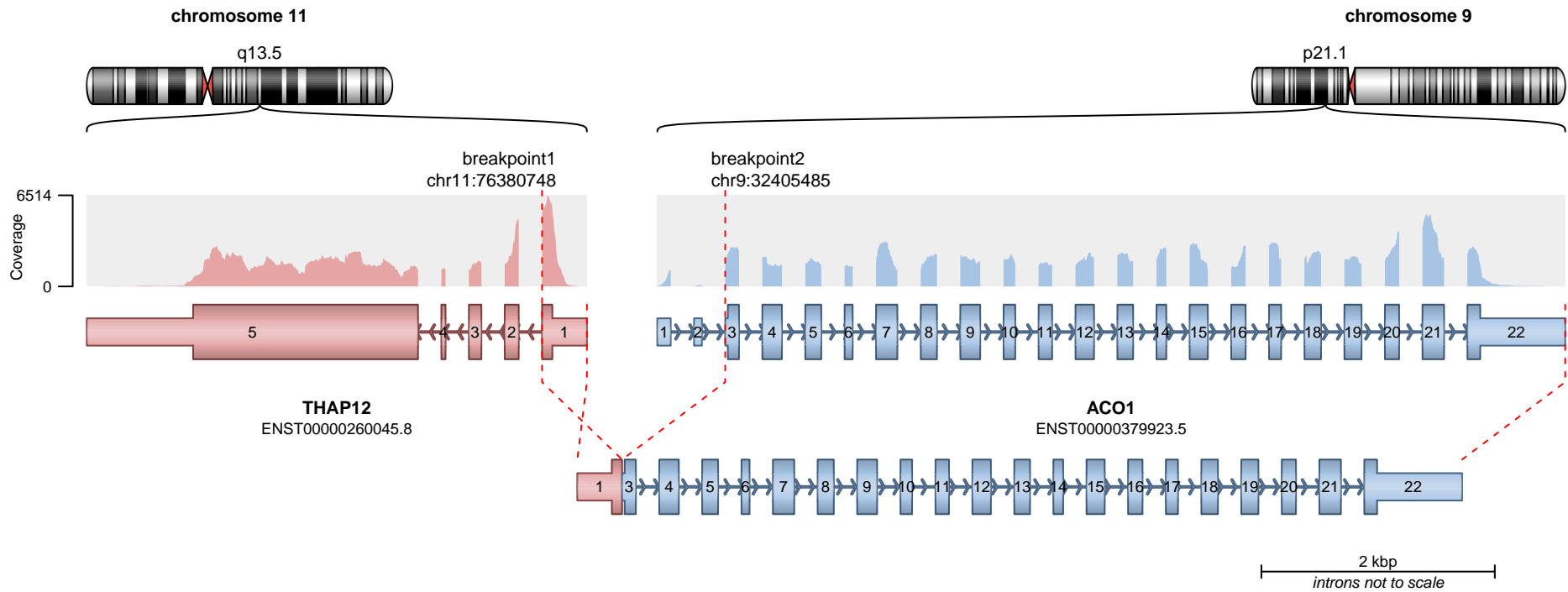

**RETAINED PROTEIN DOMAINS**  
reading frame unclear

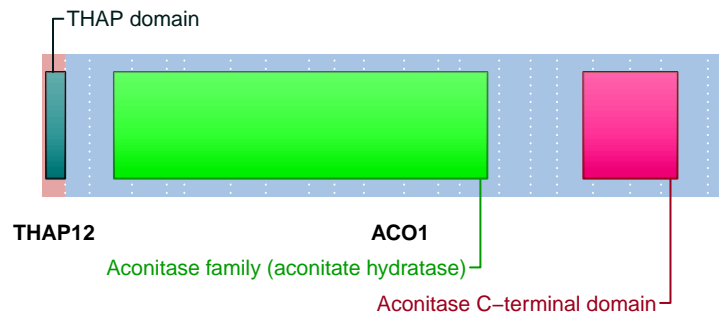

**SUPPORTING READ COUNT**

Split reads = 49  
Discordant mates = 2

— translocation — deletion  
— duplication — inversion

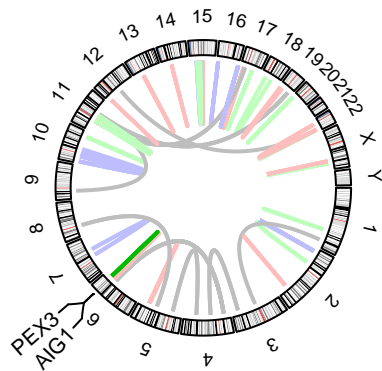
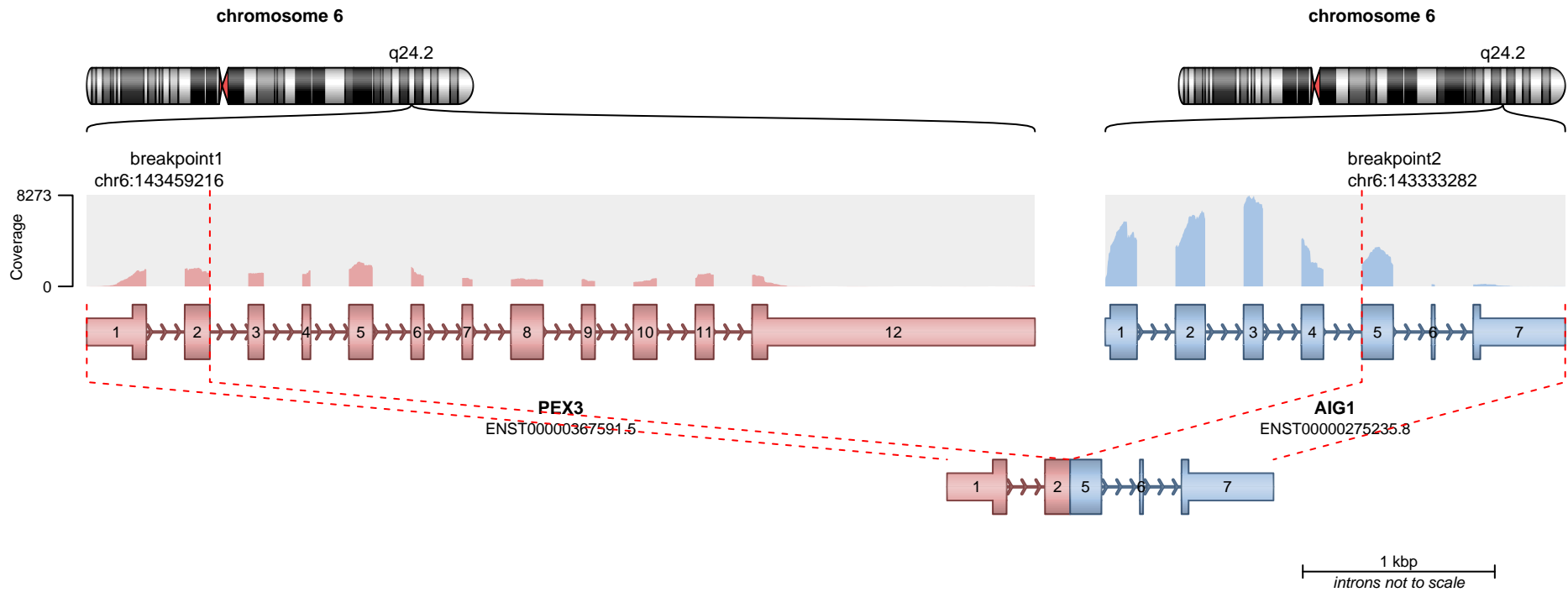

**RETAINED PROTEIN DOMAINS**  
reading frame unclear

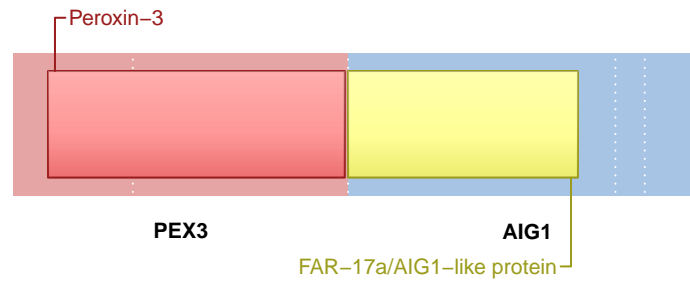

**SUPPORTING READ COUNT**

Split reads = 47  
Discordant mates = 2

- translocation
- duplication
- deletion
- inversion

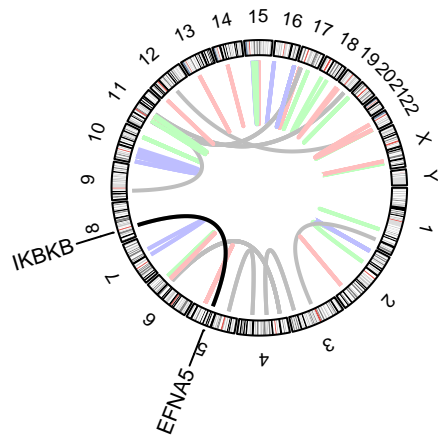
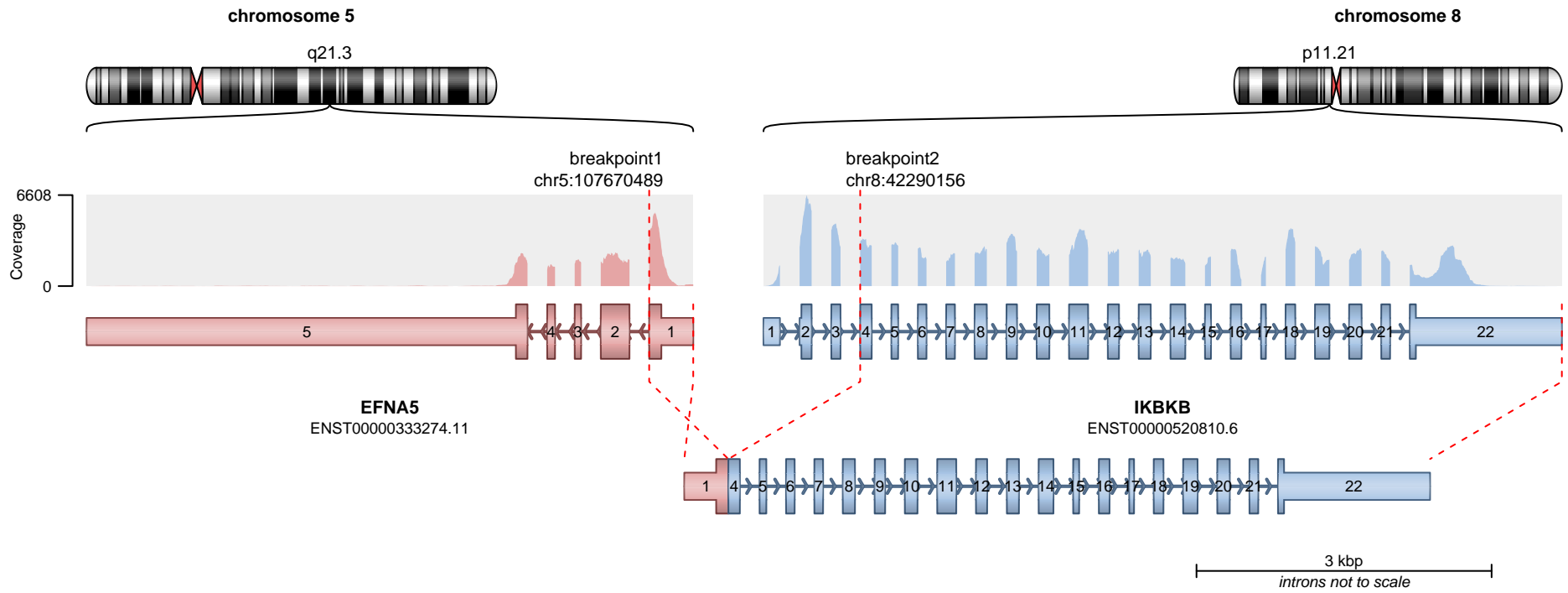

**RETAINED PROTEIN DOMAINS**  
reading frame unclear

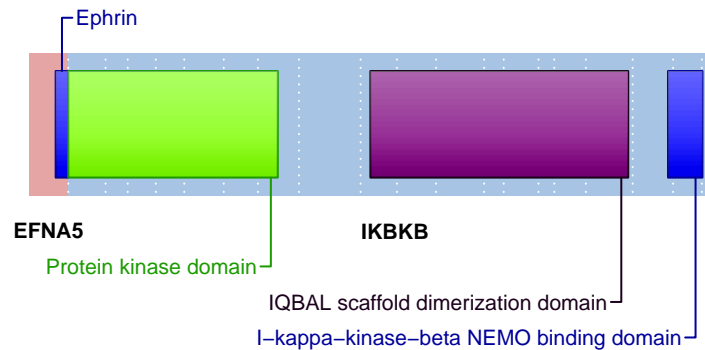

**SUPPORTING READ COUNT**

Split reads = 46  
Discordant mates = 2

— translocation    — deletion  
— duplication    — inversion

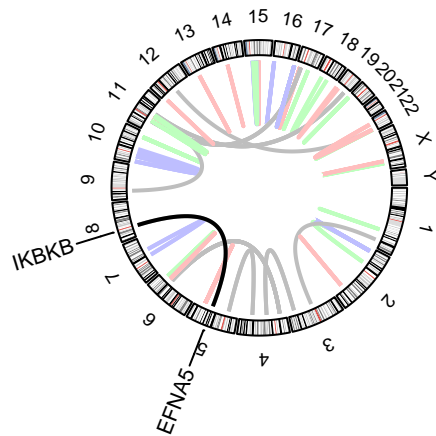
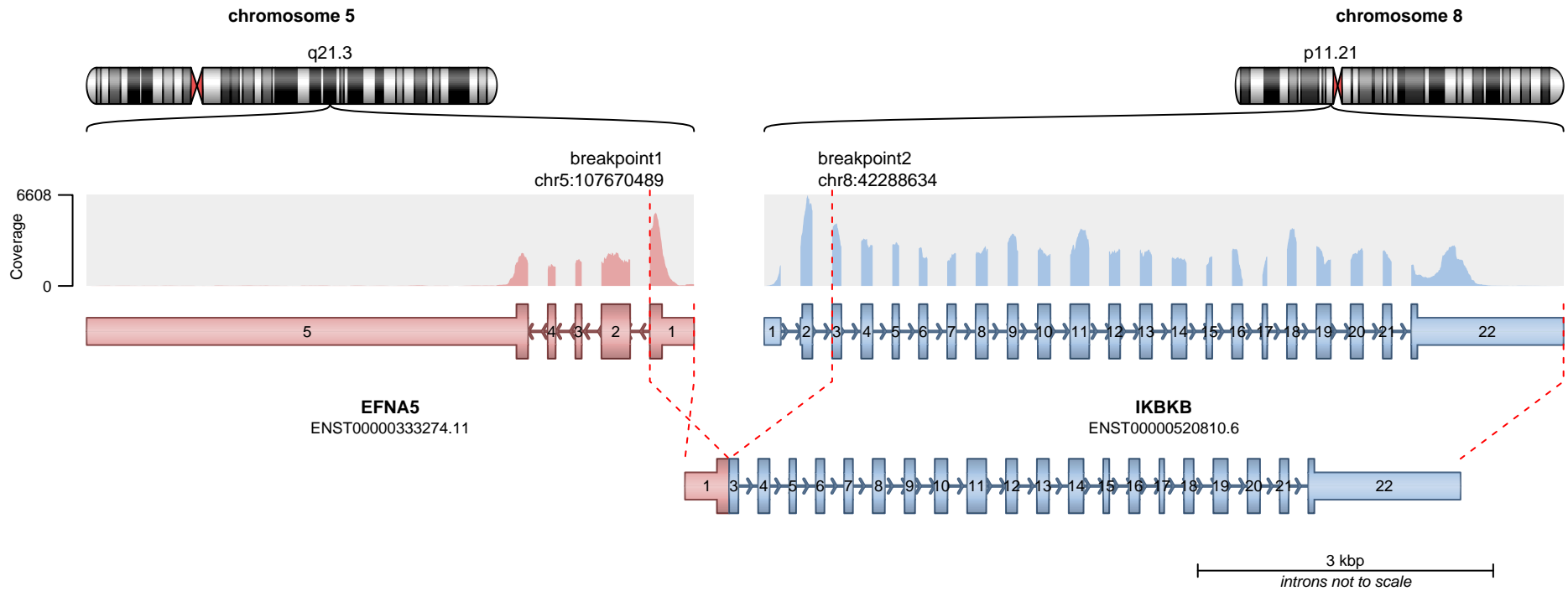

**RETAINED PROTEIN DOMAINS**  
reading frame unclear

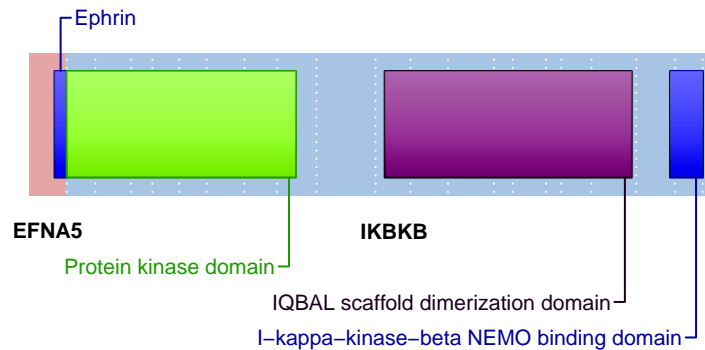

**SUPPORTING READ COUNT**

Split reads = 4  
Discordant mates = 2

- translocation
- duplication
- deletion
- inversion

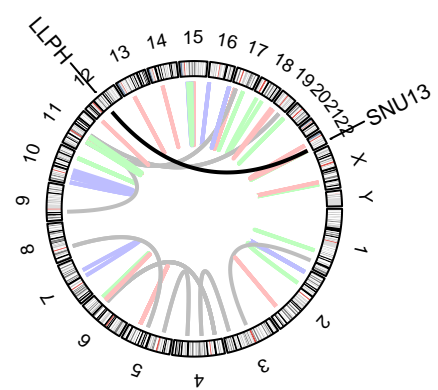
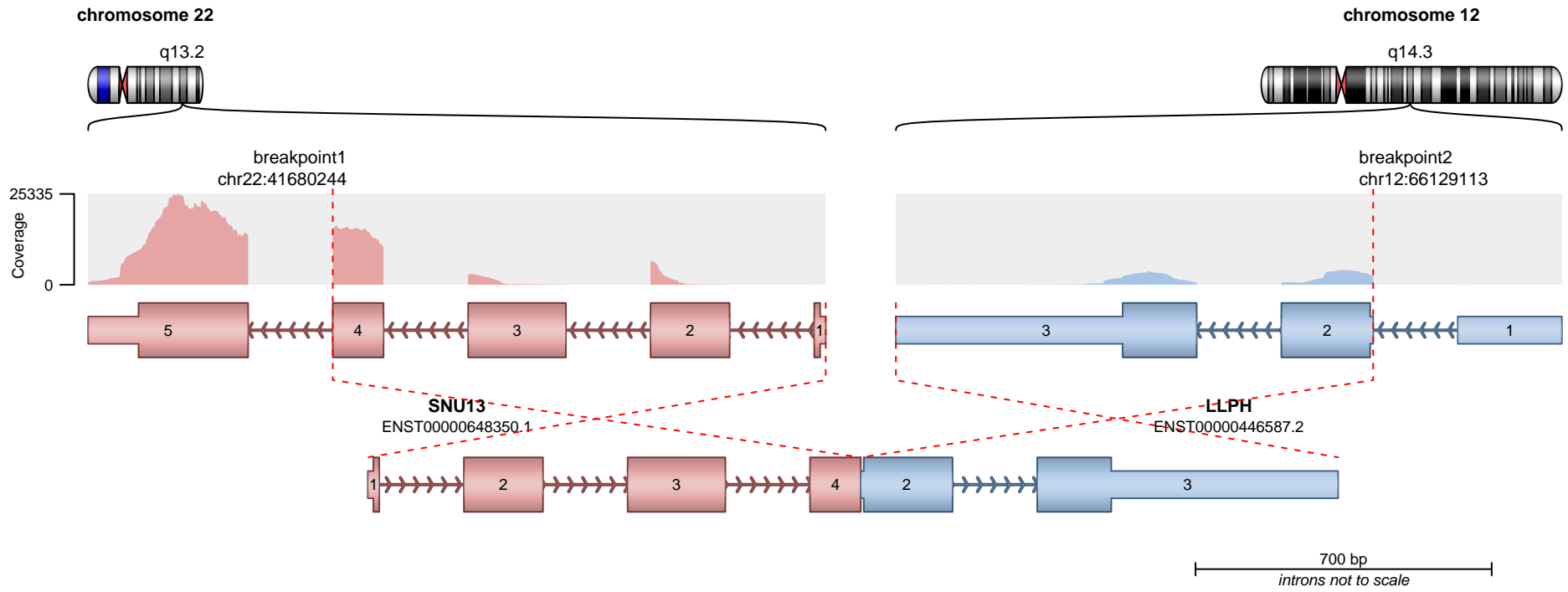

**RETAINED PROTEIN DOMAINS**  
reading frame unclear

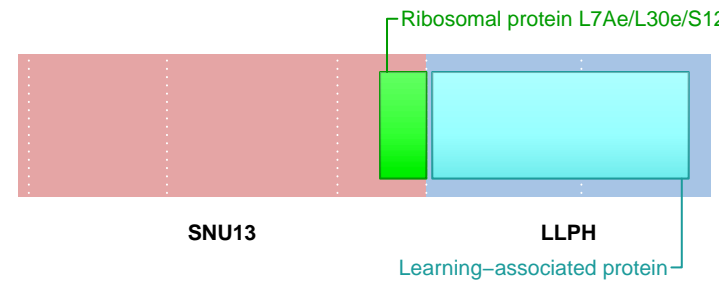

**SUPPORTING READ COUNT**

Split reads = 43  
Discordant mates = 0

- translocation
- duplication
- deletion
- inversion

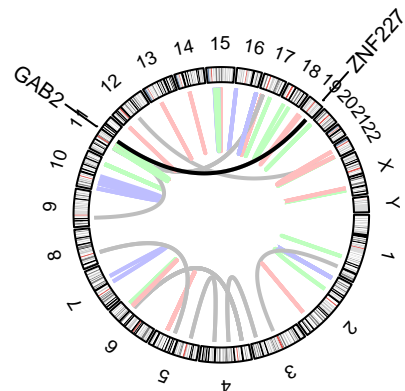
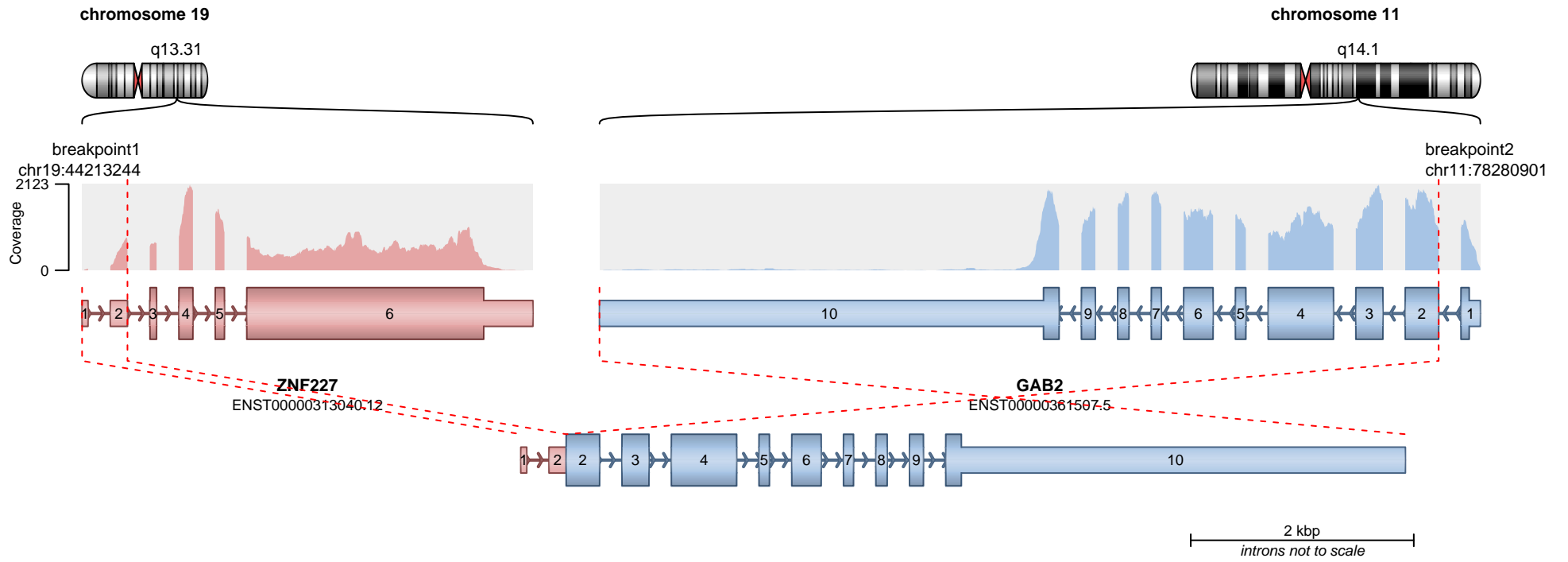

**RETAINED PROTEIN DOMAINS**  
reading frame unclear

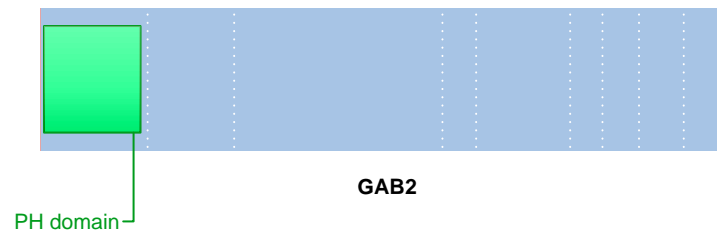

**SUPPORTING READ COUNT**

Split reads = 34  
Discordant mates = 0

— translocation — deletion  
— duplication — inversion

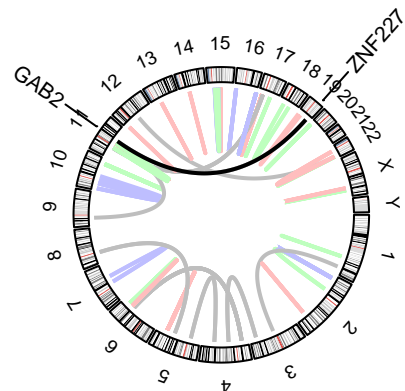
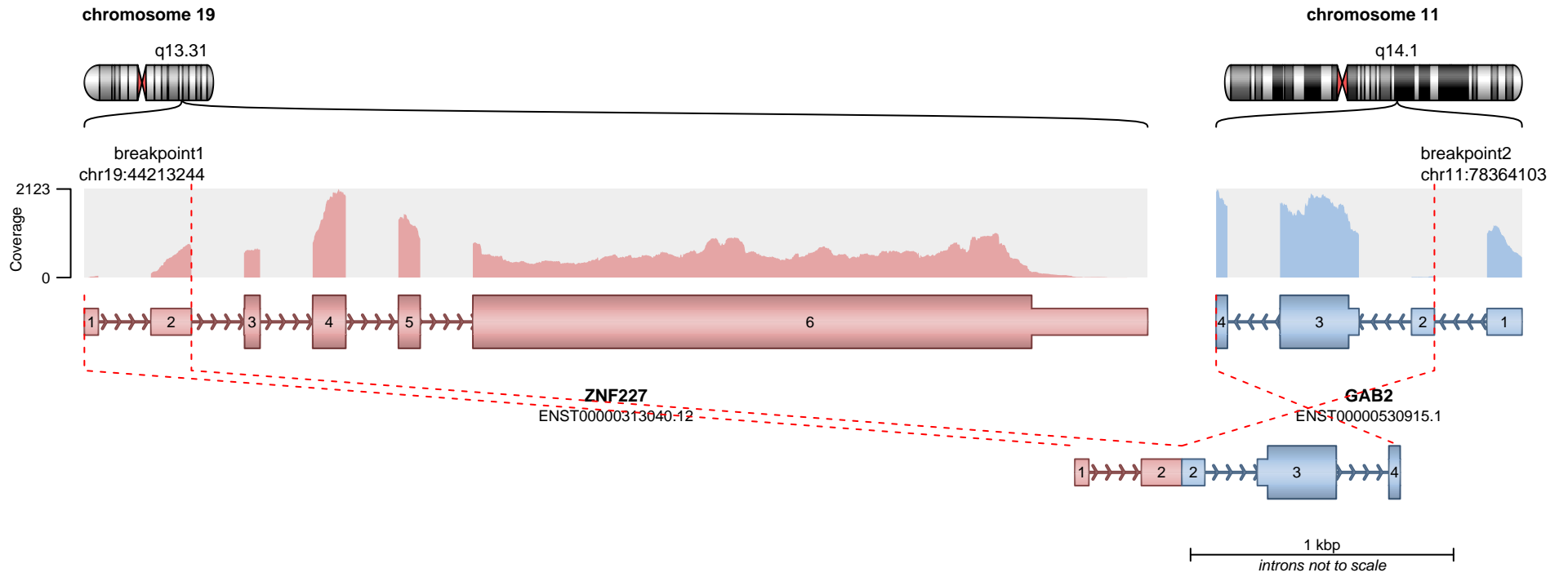

**RETAINED PROTEIN DOMAINS**  
 reading frame unclear

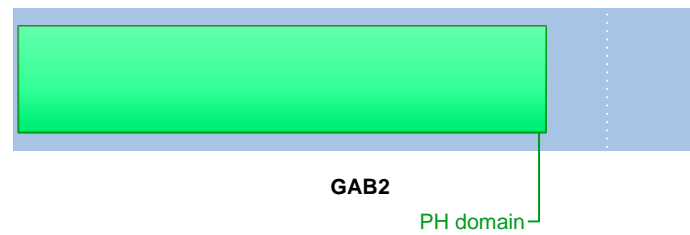

**SUPPORTING READ COUNT**

Split reads = 1  
 Discordant mates = 0

— translocation — deletion  
 — duplication — inversion

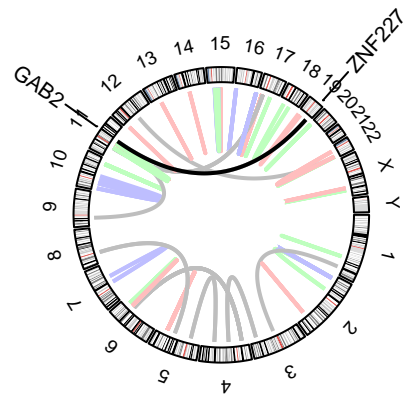
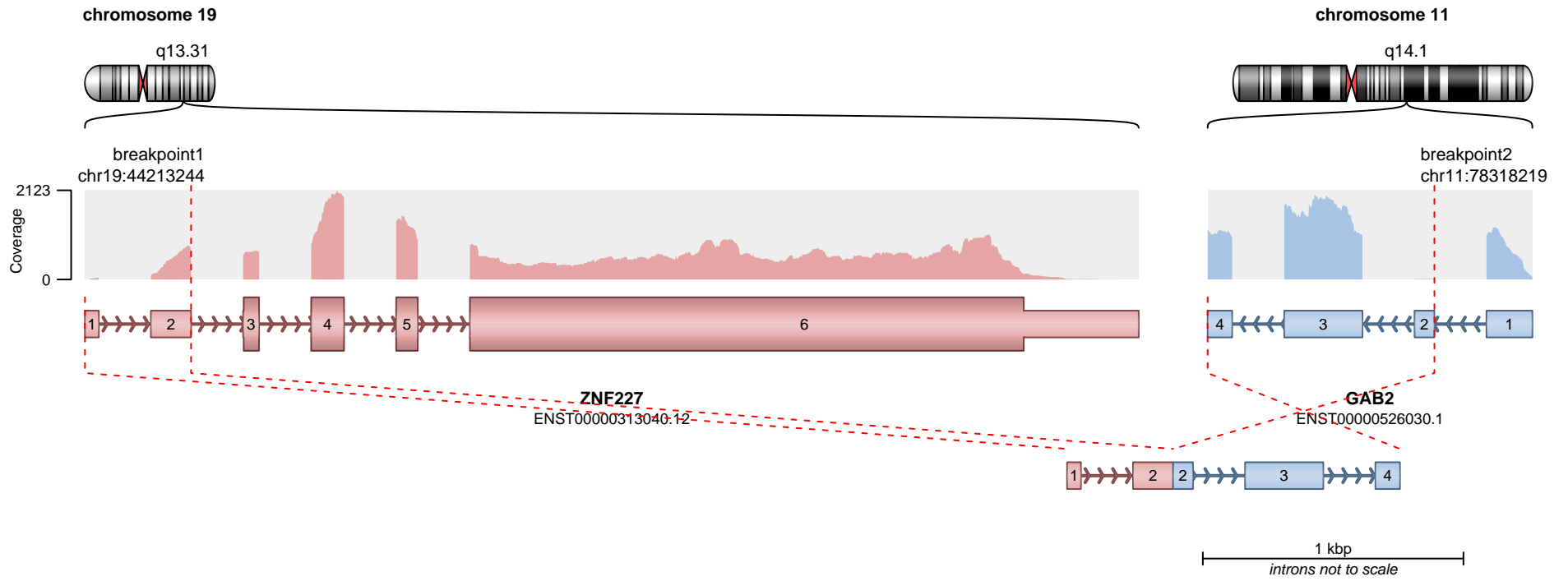

— translocation    — deletion  
— duplication    — inversion

No coding regions retained in fusion transcript.

**SUPPORTING READ COUNT**

Split reads = 1  
Discordant mates = 0

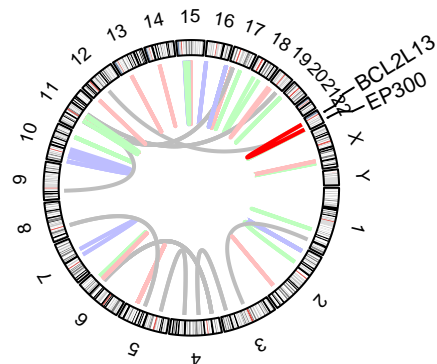
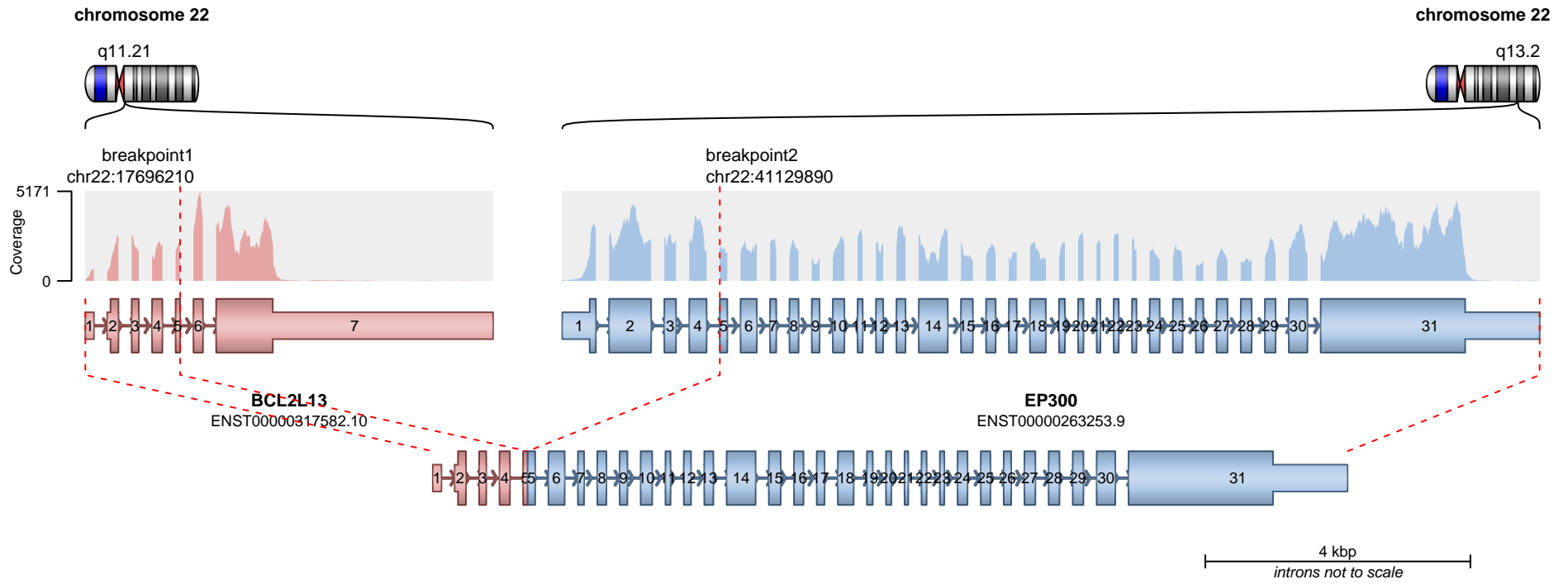

— translocation    — deletion  
— duplication    — inversion

**RETAINED PROTEIN DOMAINS**  
reading frame unclear

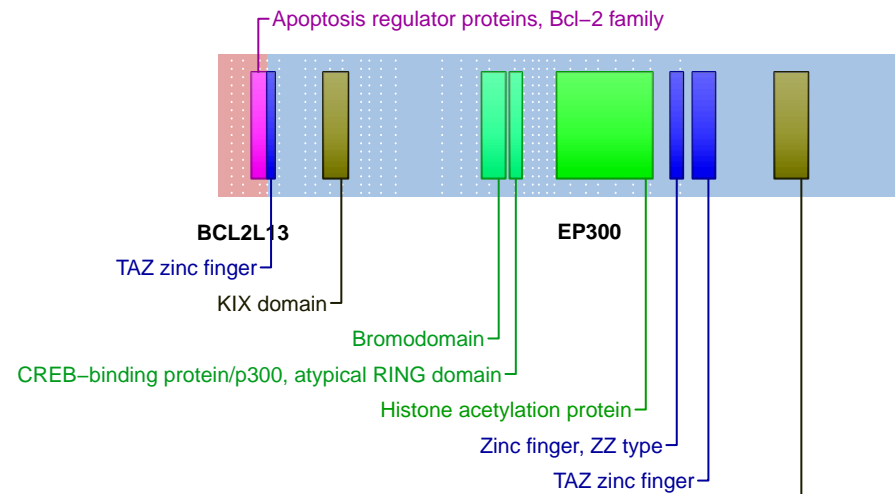

**SUPPORTING READ COUNT**

Split reads = 27  
Discordant mates = 2

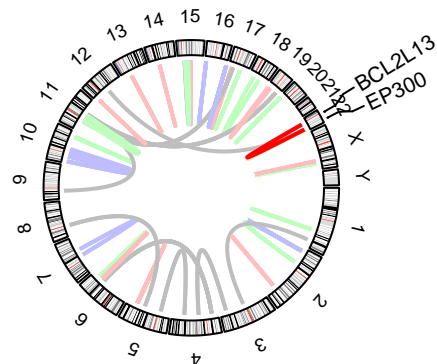
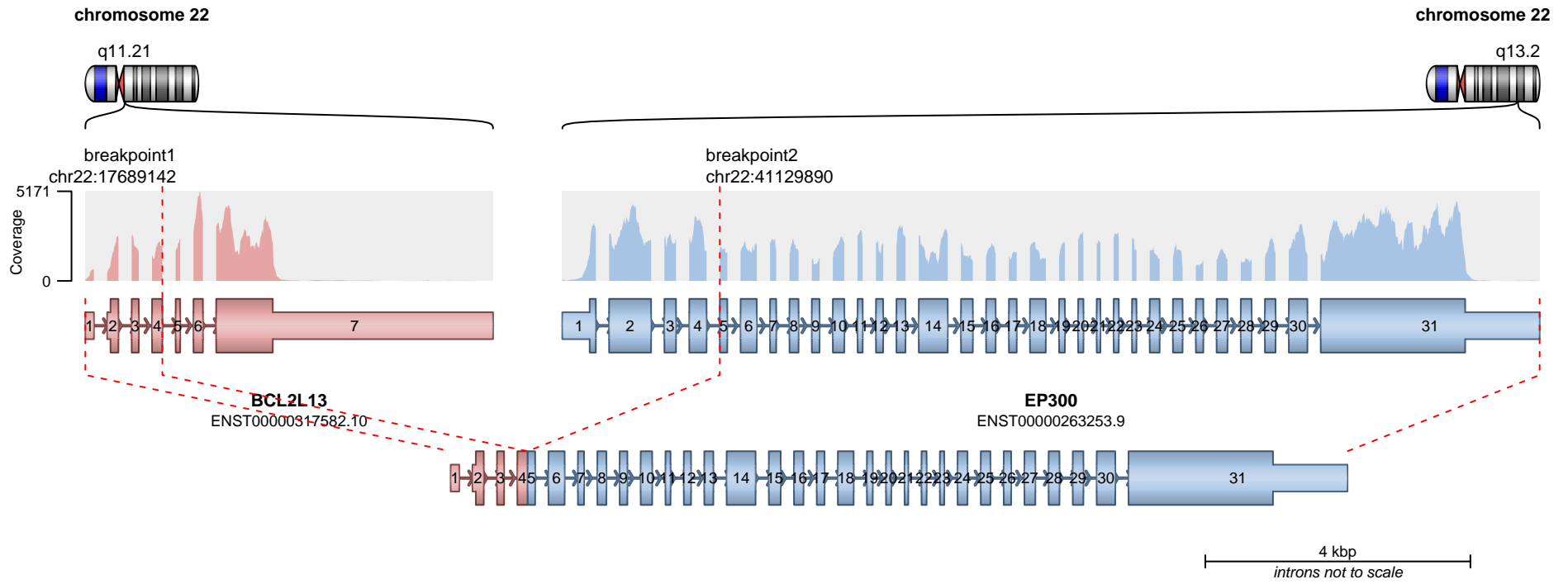

— translocation    — deletion  
— duplication    — inversion

**RETAINED PROTEIN DOMAINS**  
reading frame unclear

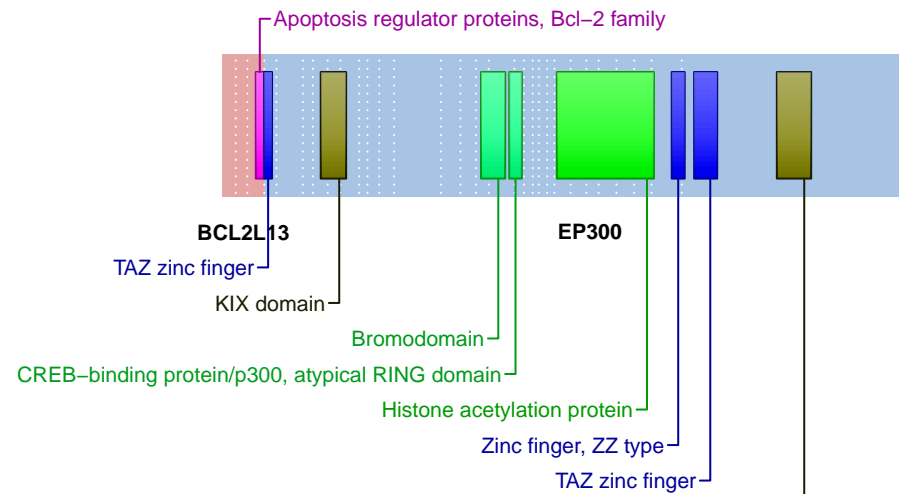

**SUPPORTING READ COUNT**

Split reads = 10  
Discordant mates = 0

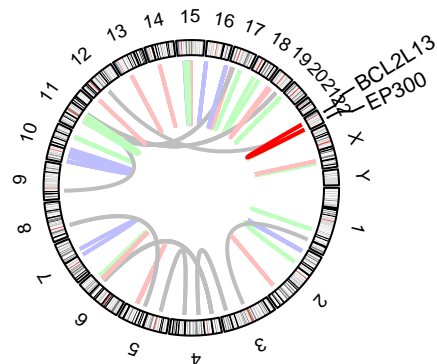
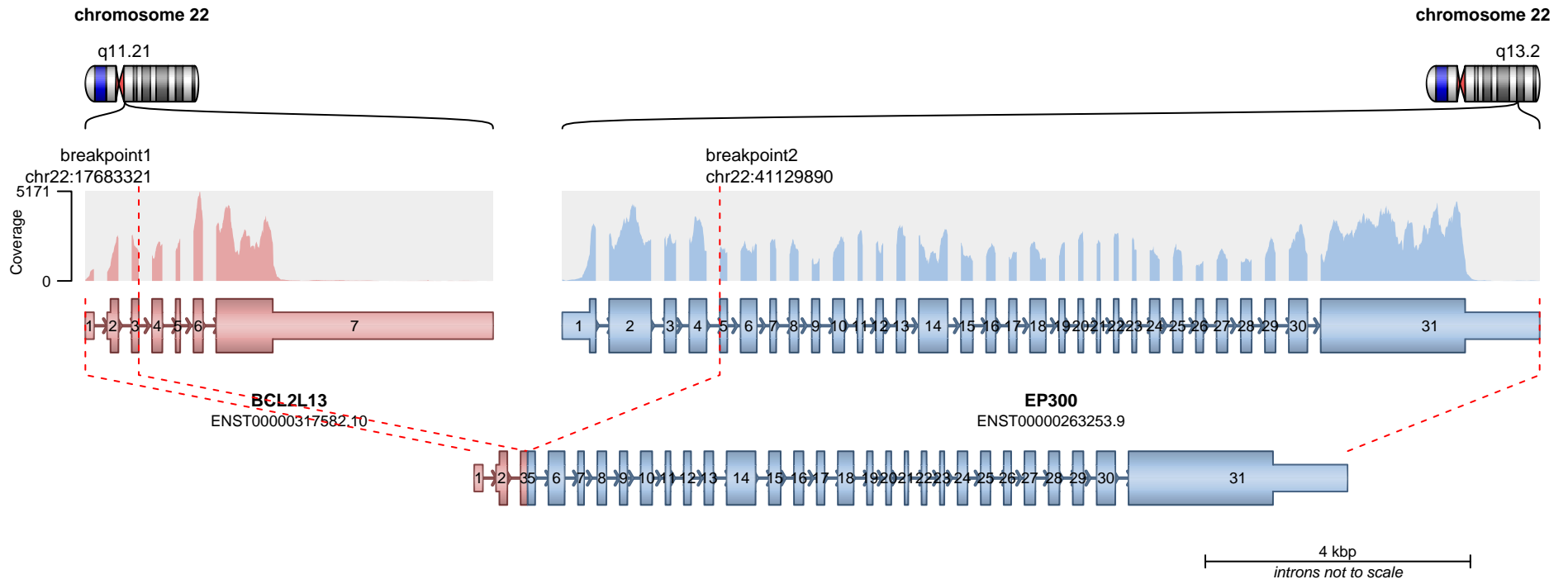

— translocation    — deletion  
 — duplication    — inversion

**RETAINED PROTEIN DOMAINS**  
reading frame unclear

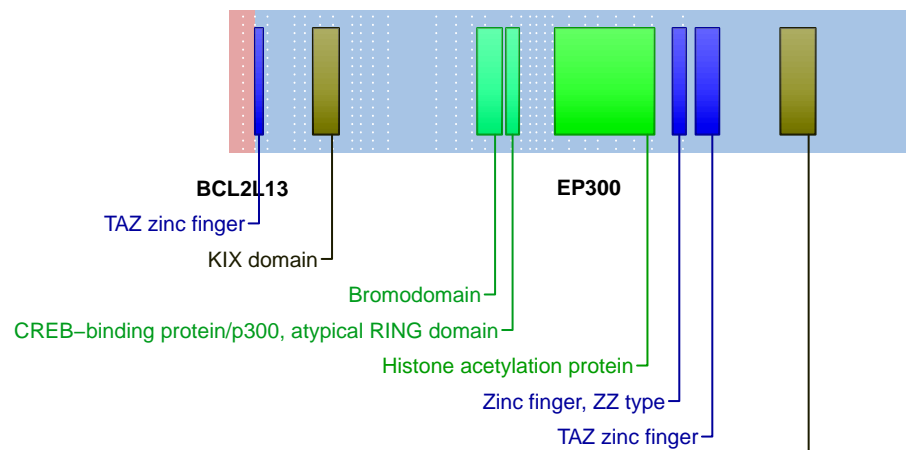

**SUPPORTING READ COUNT**

Split reads = 3  
 Discordant mates = 0

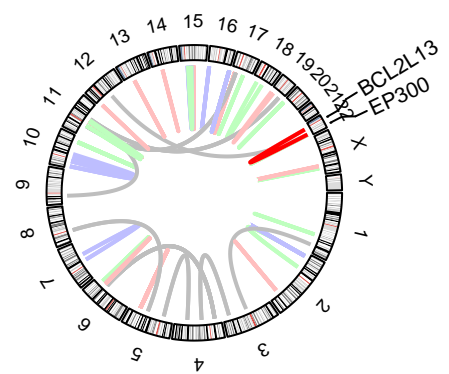
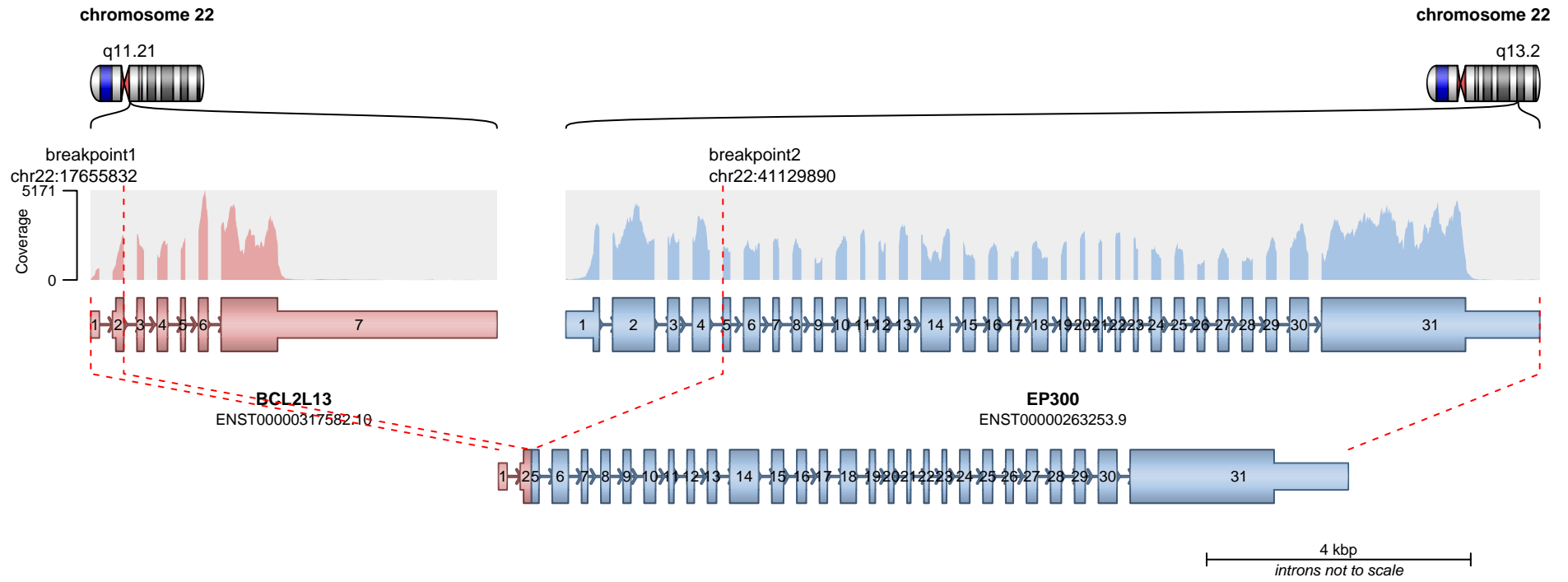

— translocation    — deletion  
— duplication    — inversion

**RETAINED PROTEIN DOMAINS**  
reading frame unclear

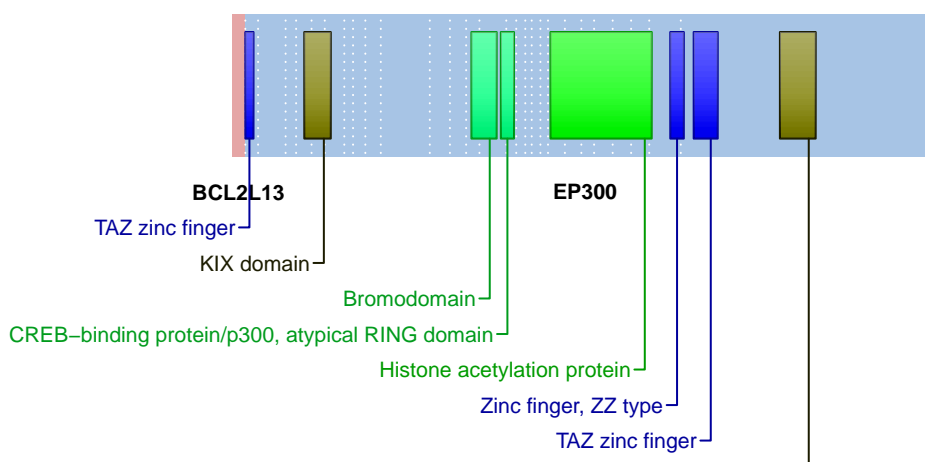

**SUPPORTING READ COUNT**

Split reads = 2  
Discordant mates = 0

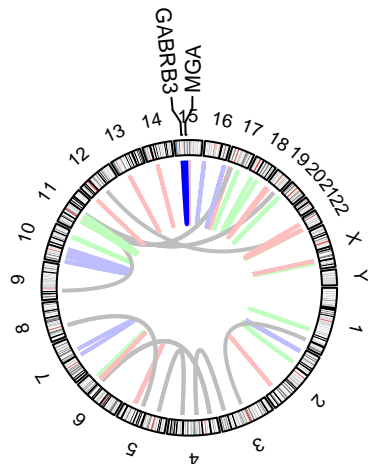
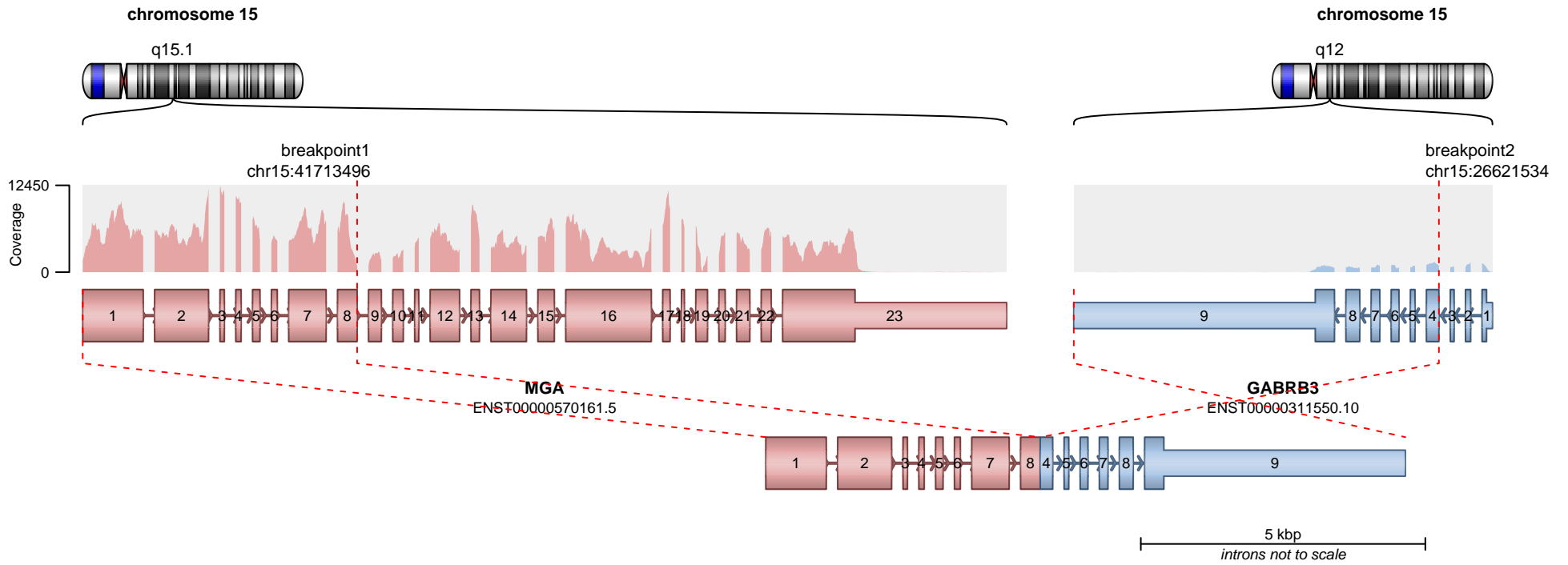

**RETAINED PROTEIN DOMAINS**  
reading frame unclear

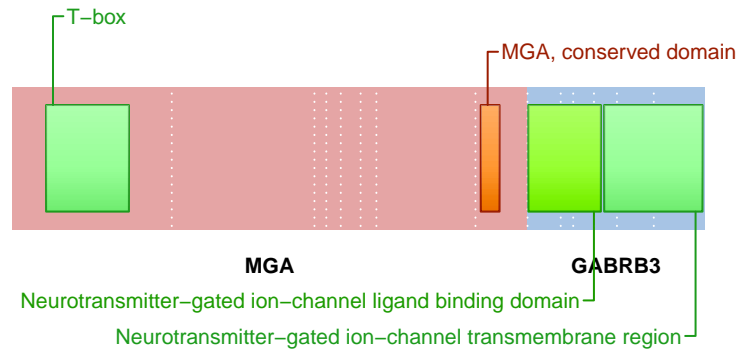

**SUPPORTING READ COUNT**

Split reads = 27  
Discordant mates = 0

— translocation    — deletion  
— duplication    — inversion

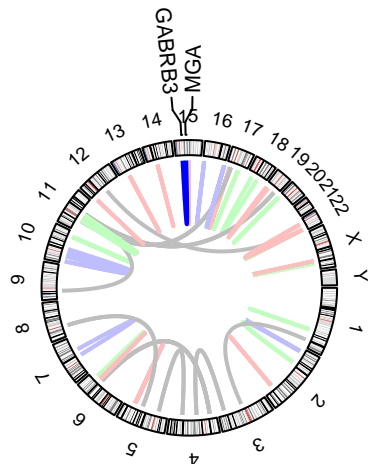
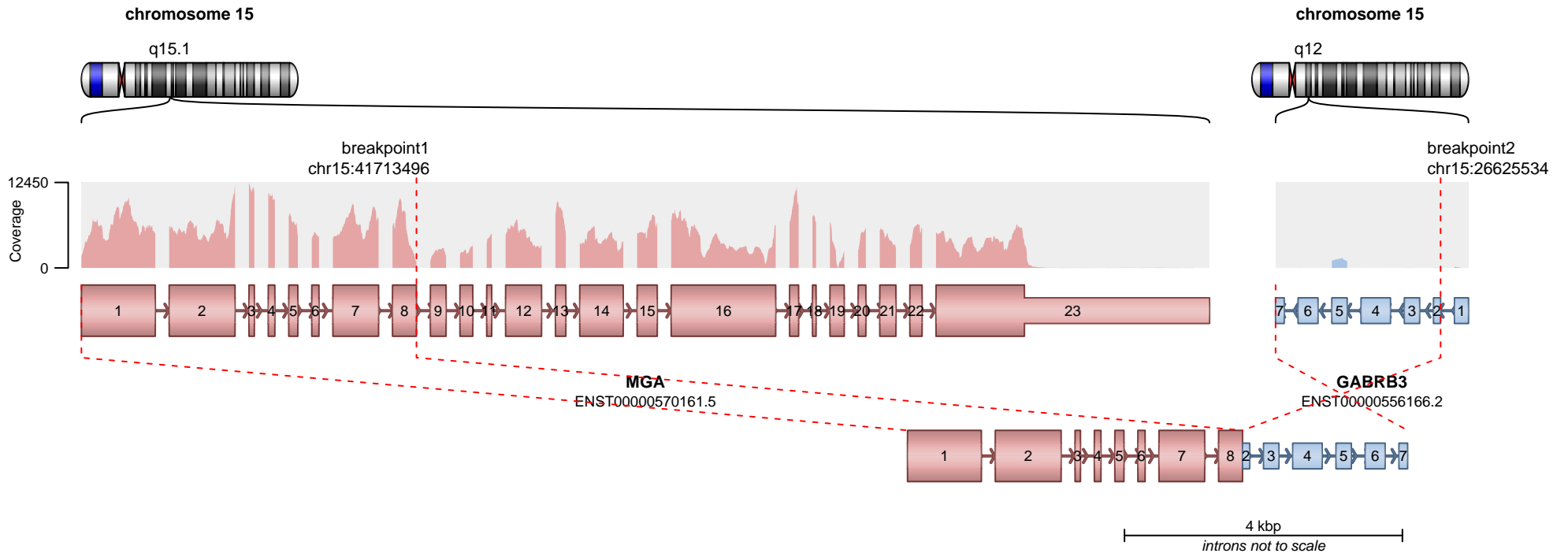

**RETAINED PROTEIN DOMAINS**  
reading frame unclear



**SUPPORTING READ COUNT**

Split reads = 11  
Discordant mates = 0

- translocation
- duplication
- deletion
- inversion

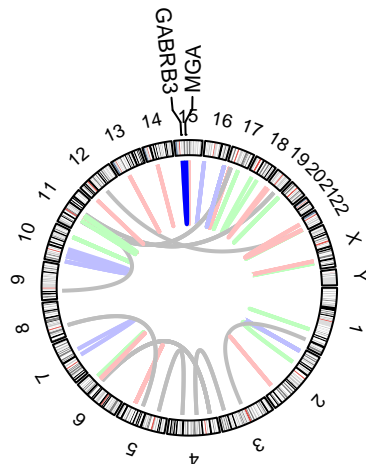
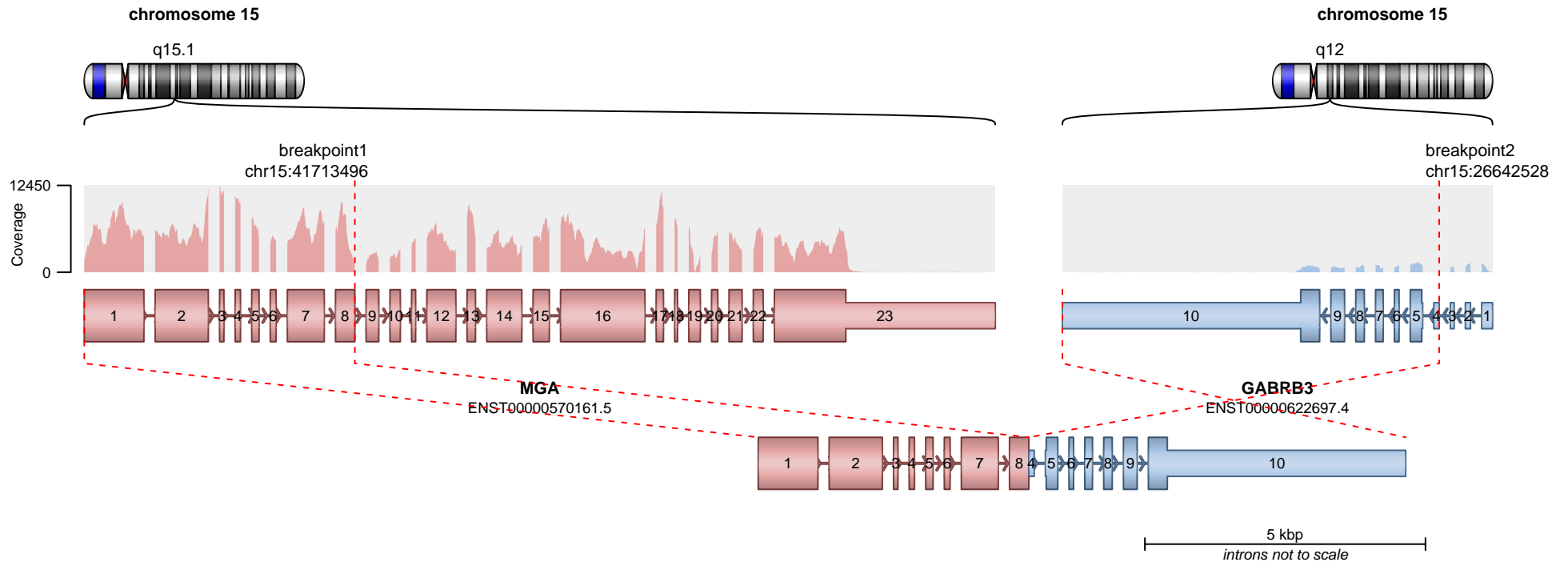

**RETAINED PROTEIN DOMAINS**  
reading frame unclear

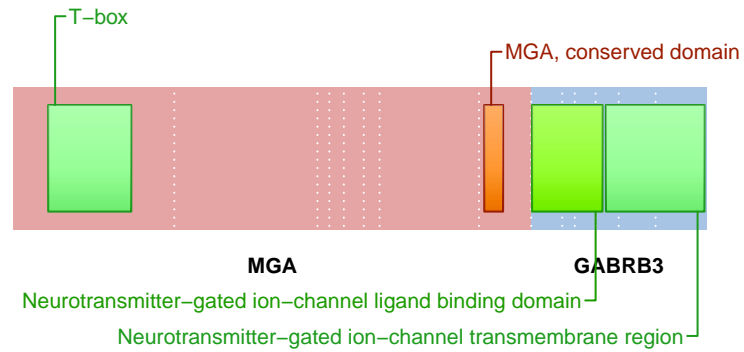

**SUPPORTING READ COUNT**

Split reads = 1  
Discordant mates = 0

— translocation — deletion  
— duplication — inversion

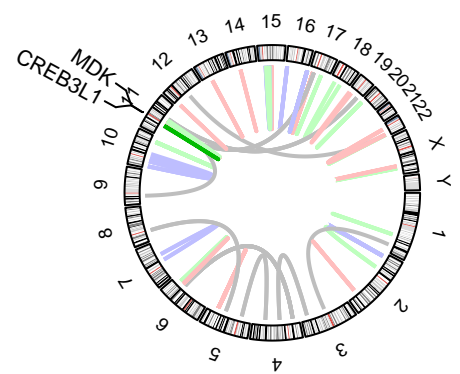
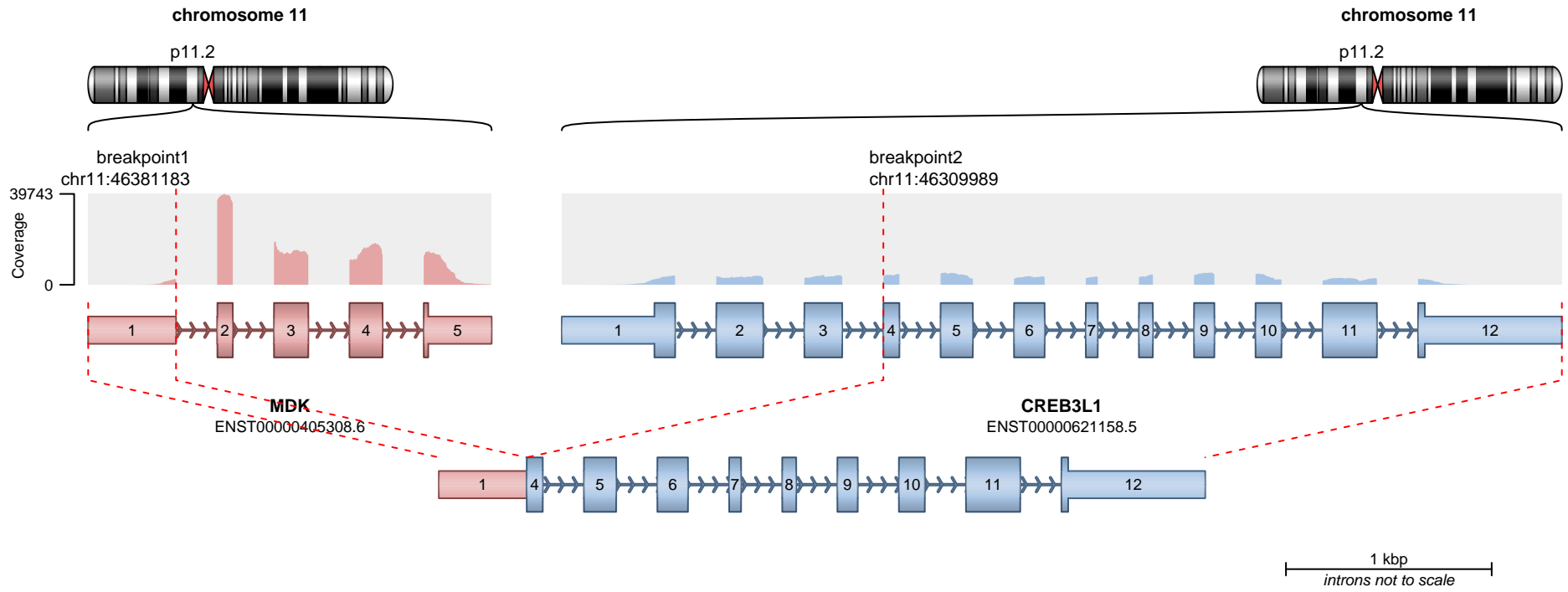

**RETAINED PROTEIN DOMAINS**  
reading frame unclear

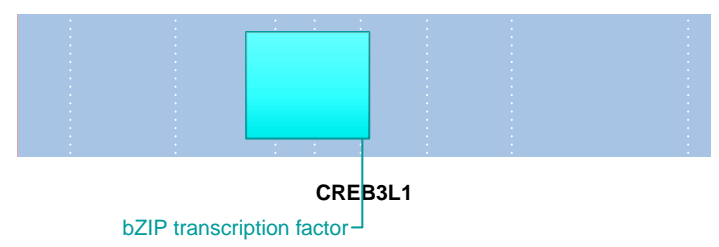

**SUPPORTING READ COUNT**

Split reads = 26  
Discordant mates = 0

— translocation — deletion  
— duplication — inversion

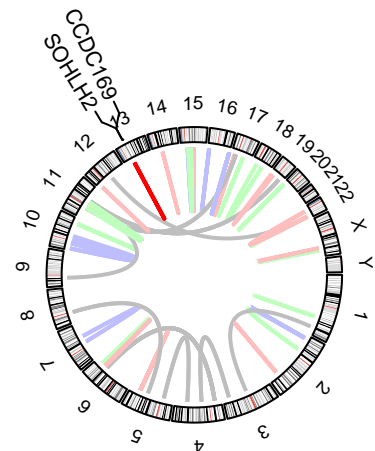
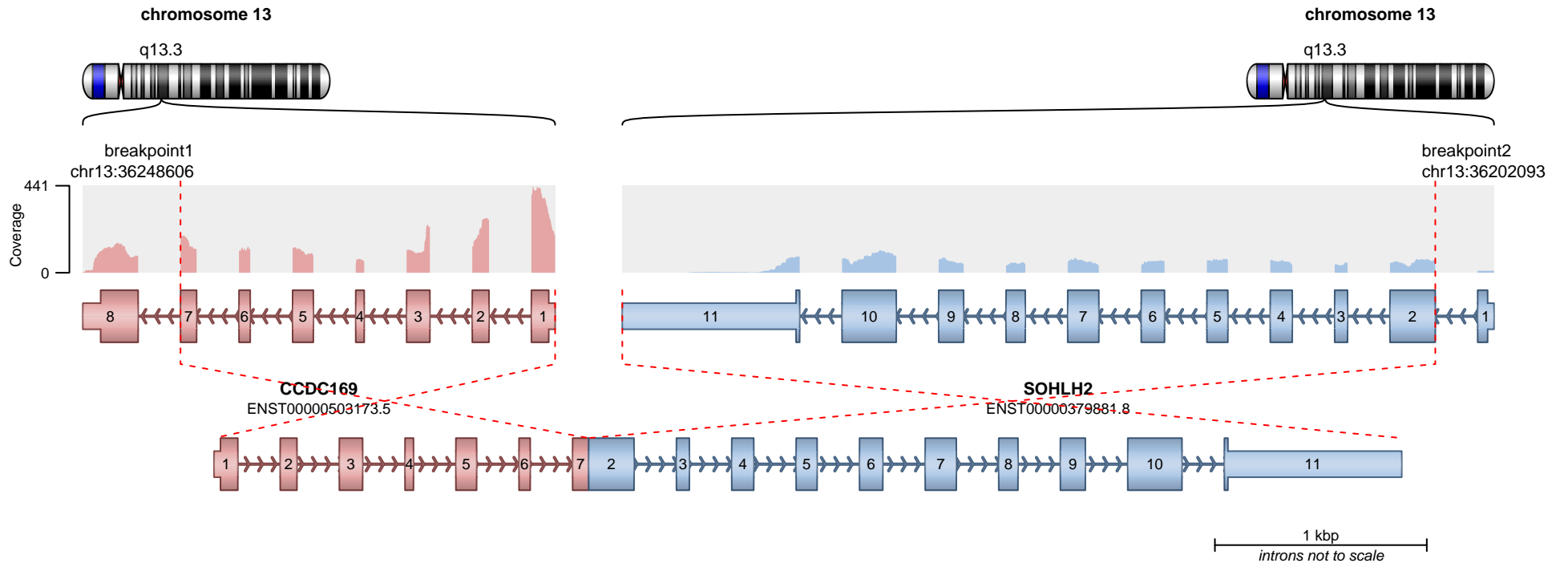

**RETAINED PROTEIN DOMAINS**  
reading frame unclear

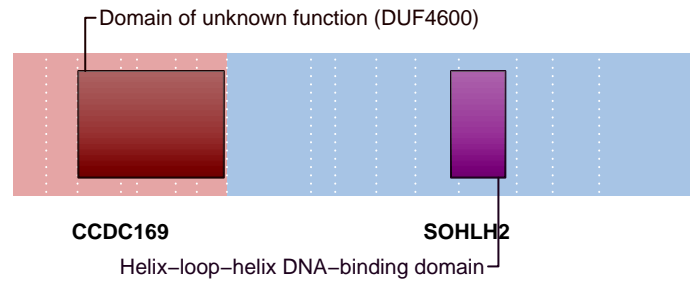

**SUPPORTING READ COUNT**

Split reads = 20  
Discordant mates = 0

— translocation — deletion  
— duplication — inversion

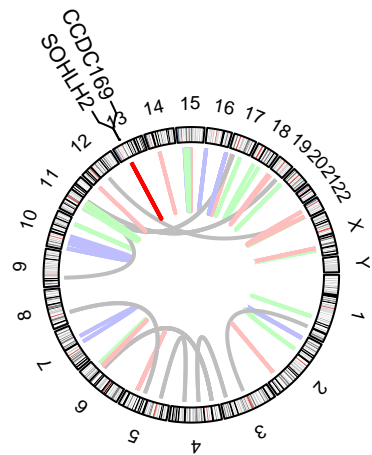
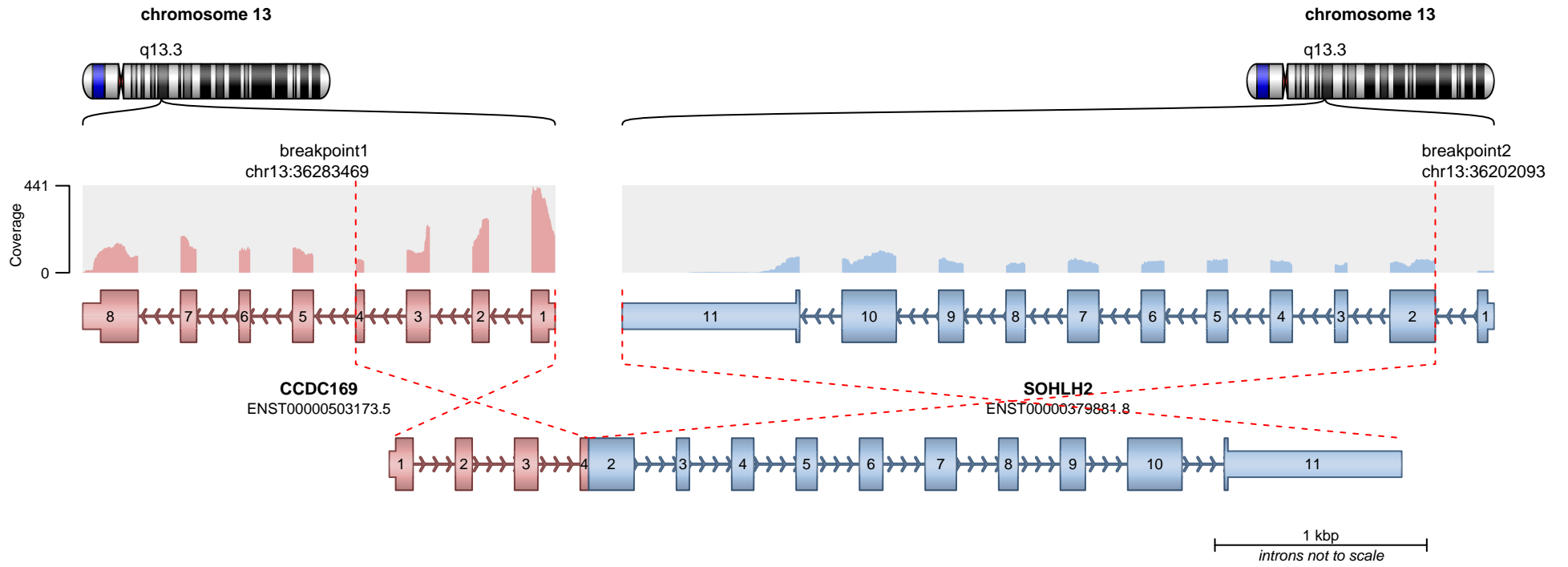

**RETAINED PROTEIN DOMAINS**  
reading frame unclear

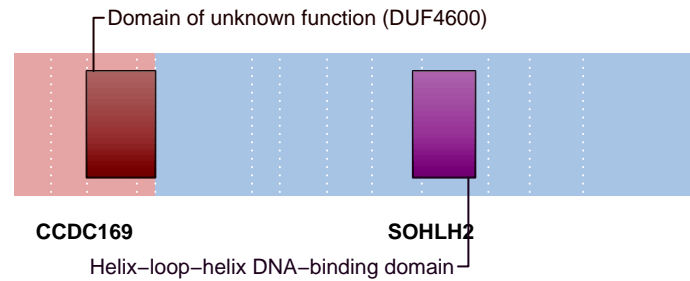

**SUPPORTING READ COUNT**

Split reads = 1  
Discordant mates = 0

— translocation — deletion  
— duplication — inversion

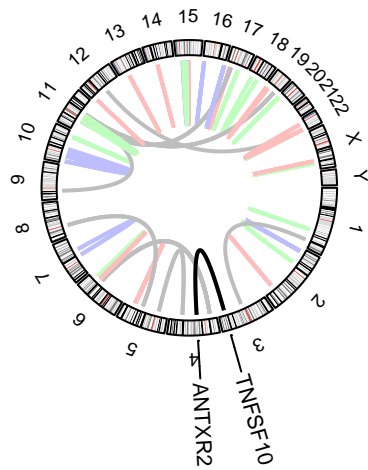
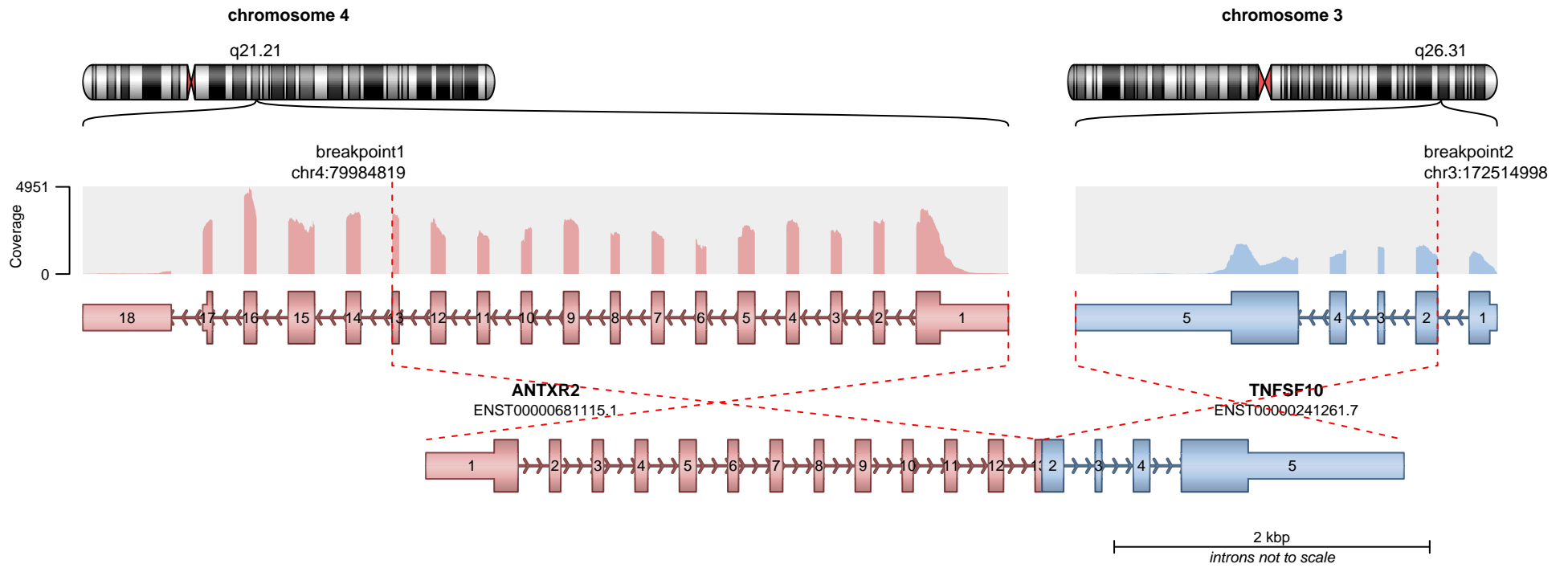

**RETAINED PROTEIN DOMAINS**  
reading frame unclear

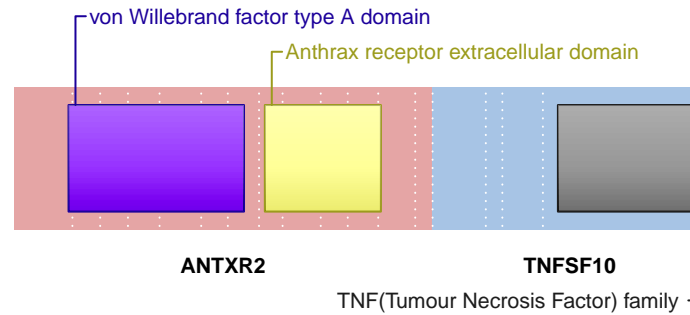

**SUPPORTING READ COUNT**

Split reads = 17  
Discordant mates = 1

— translocation — deletion  
— duplication — inversion

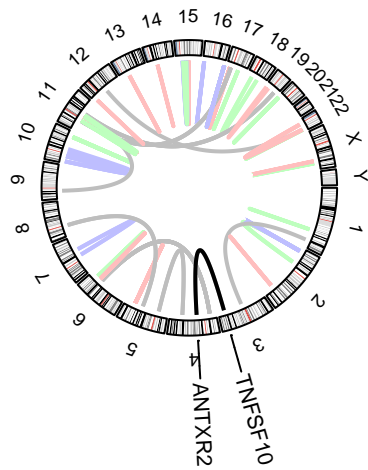
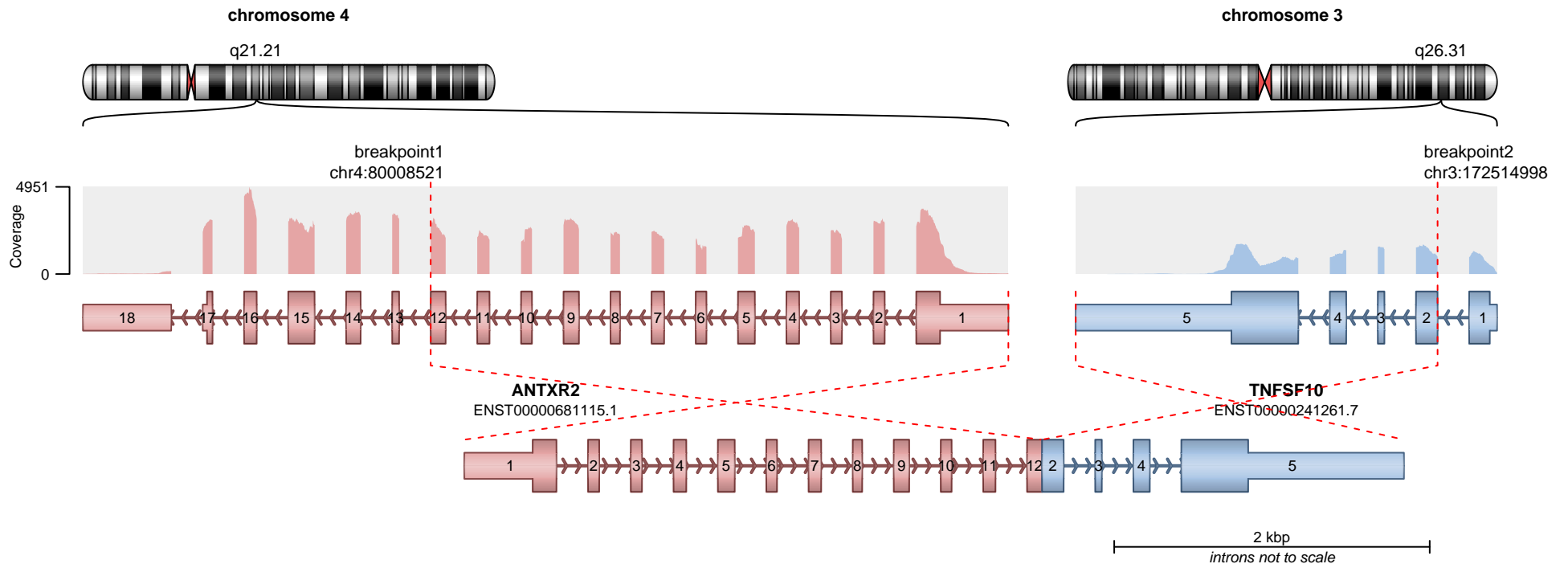

**RETAINED PROTEIN DOMAINS**  
reading frame unclear

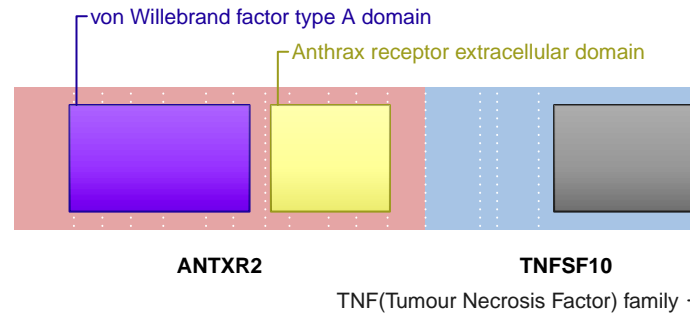

**SUPPORTING READ COUNT**

Split reads = 5  
Discordant mates = 1

— translocation — deletion  
— duplication — inversion

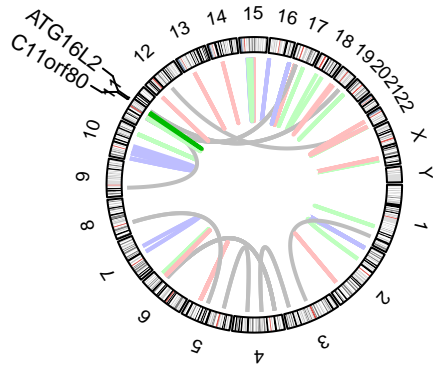
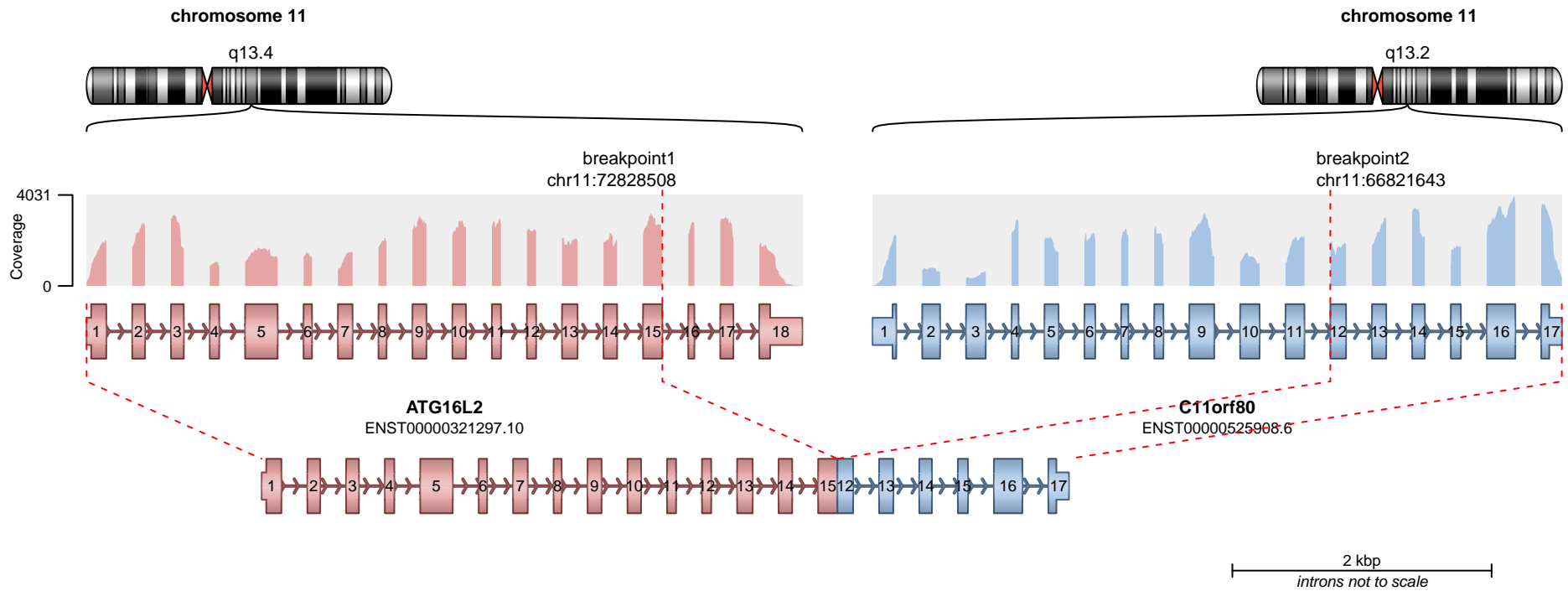

**RETAINED PROTEIN DOMAINS**  
reading frame unclear

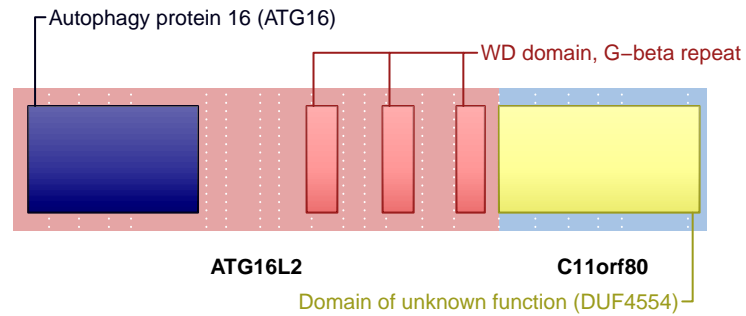

**SUPPORTING READ COUNT**

Split reads = 16  
Discordant mates = 1

- translocation
- duplication
- deletion
- inversion

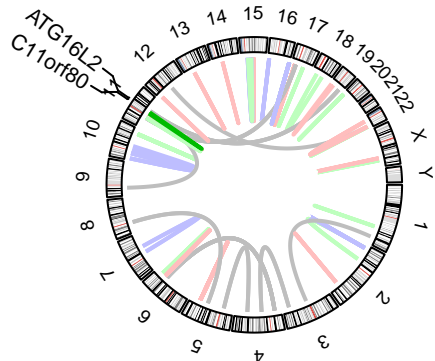
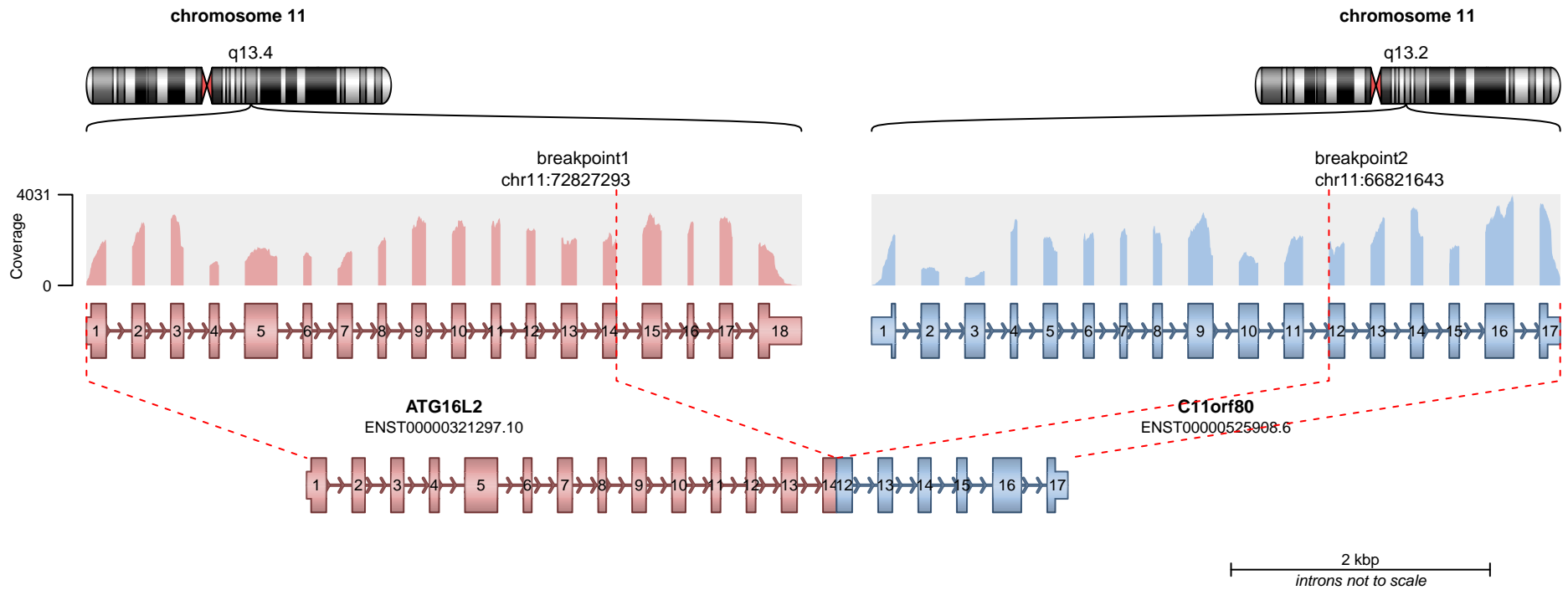

**RETAINED PROTEIN DOMAINS**  
reading frame unclear

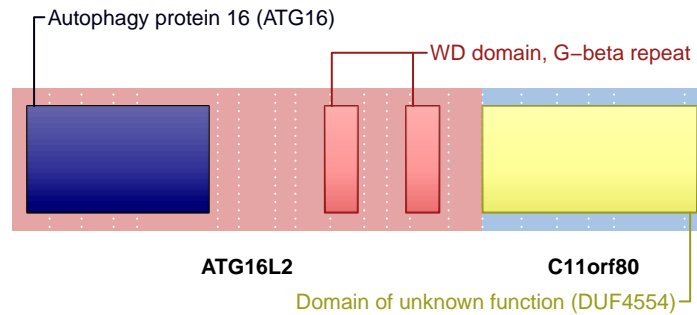

**SUPPORTING READ COUNT**

Split reads = 4  
Discordant mates = 0

- translocation
- duplication
- deletion
- inversion



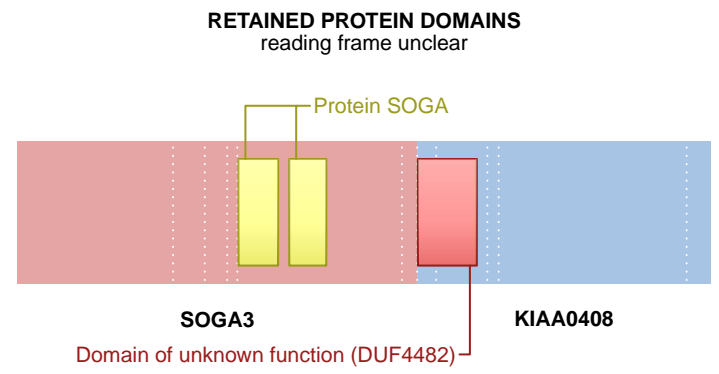
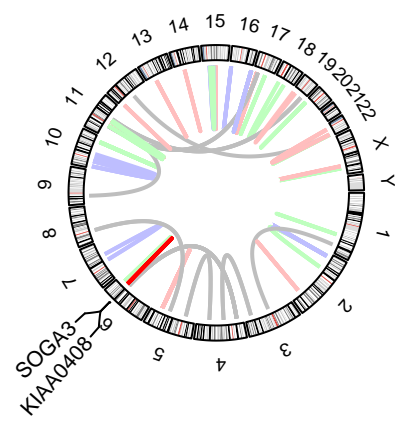
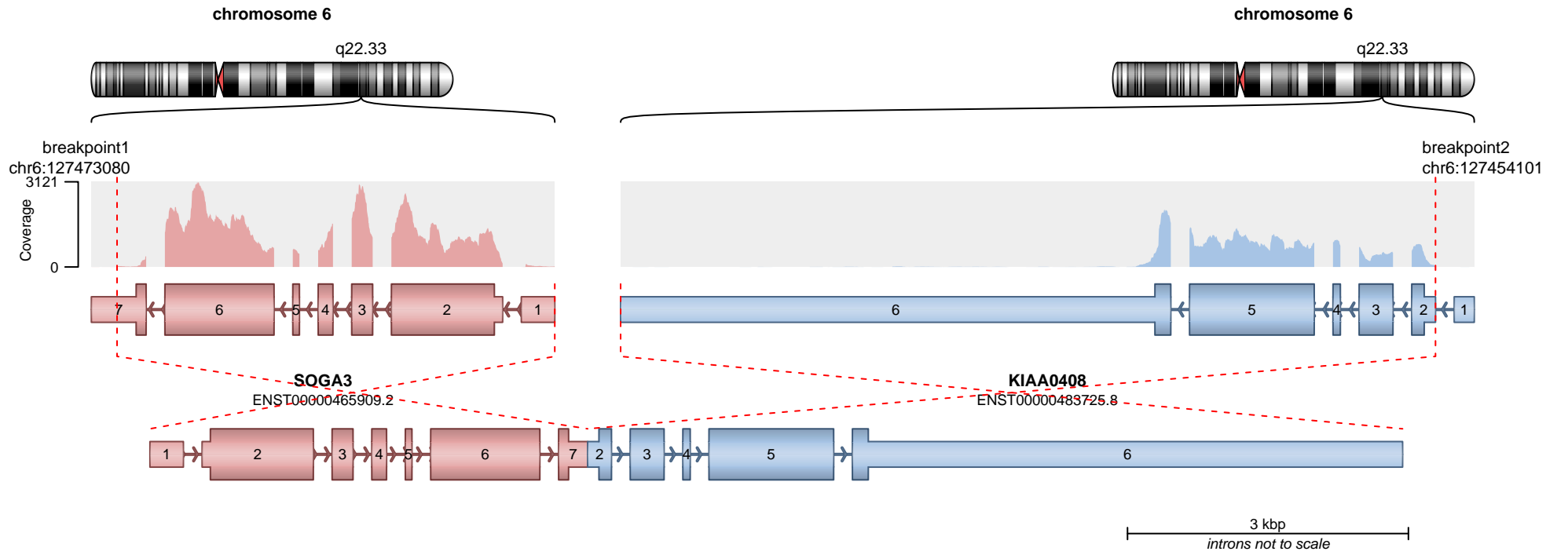

**SUPPORTING READ COUNT**

Split reads = 15  
Discordant mates = 1

— translocation — deletion  
— duplication — inversion

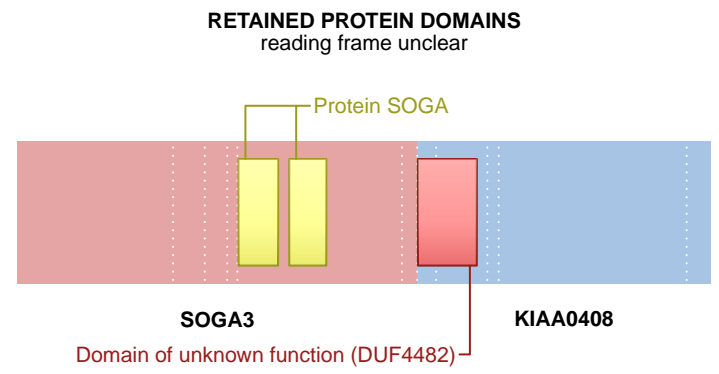
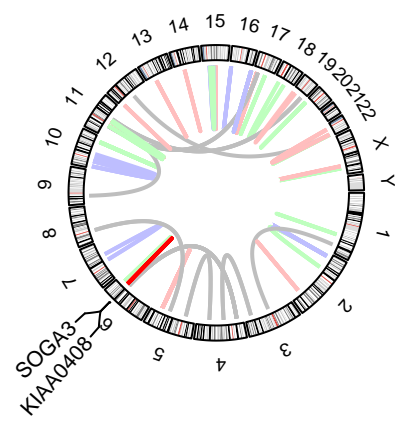
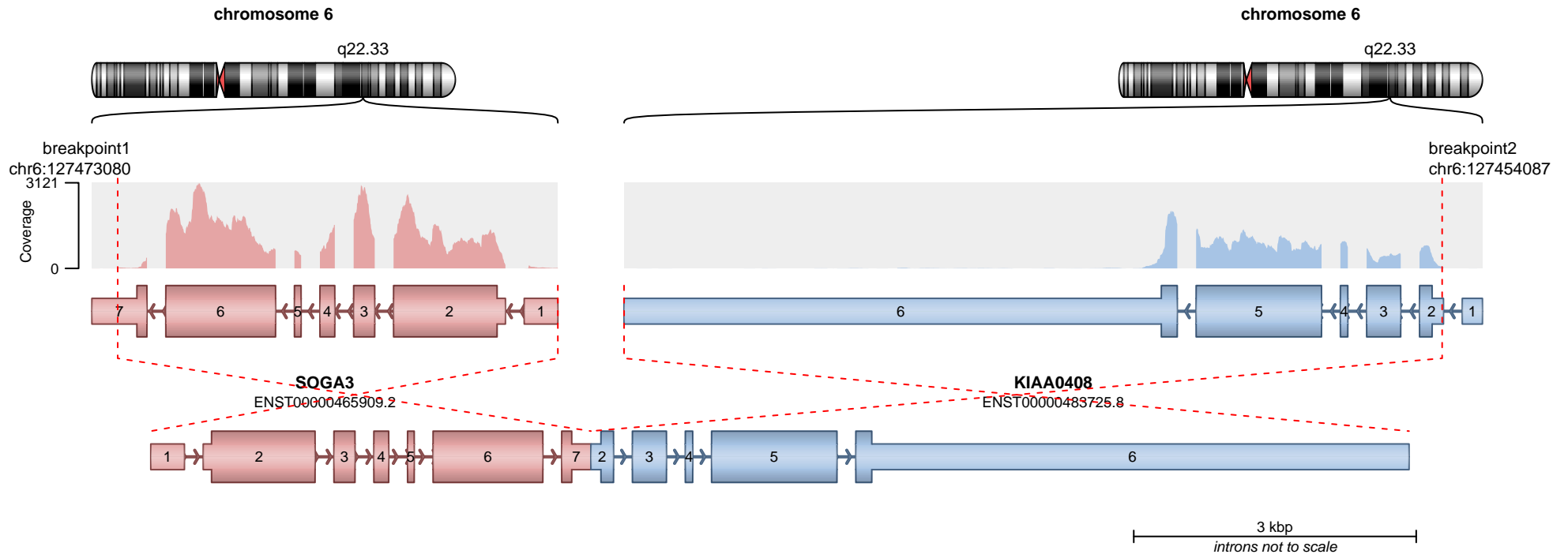

**SUPPORTING READ COUNT**

Split reads = 3  
Discordant mates = 1

— translocation — deletion  
— duplication — inversion

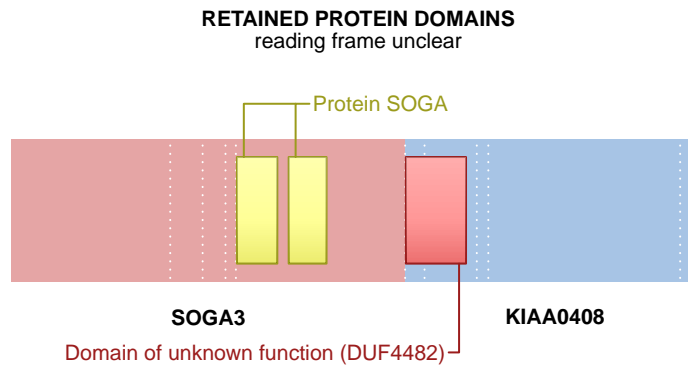
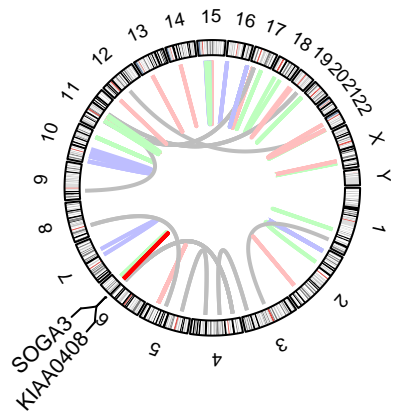
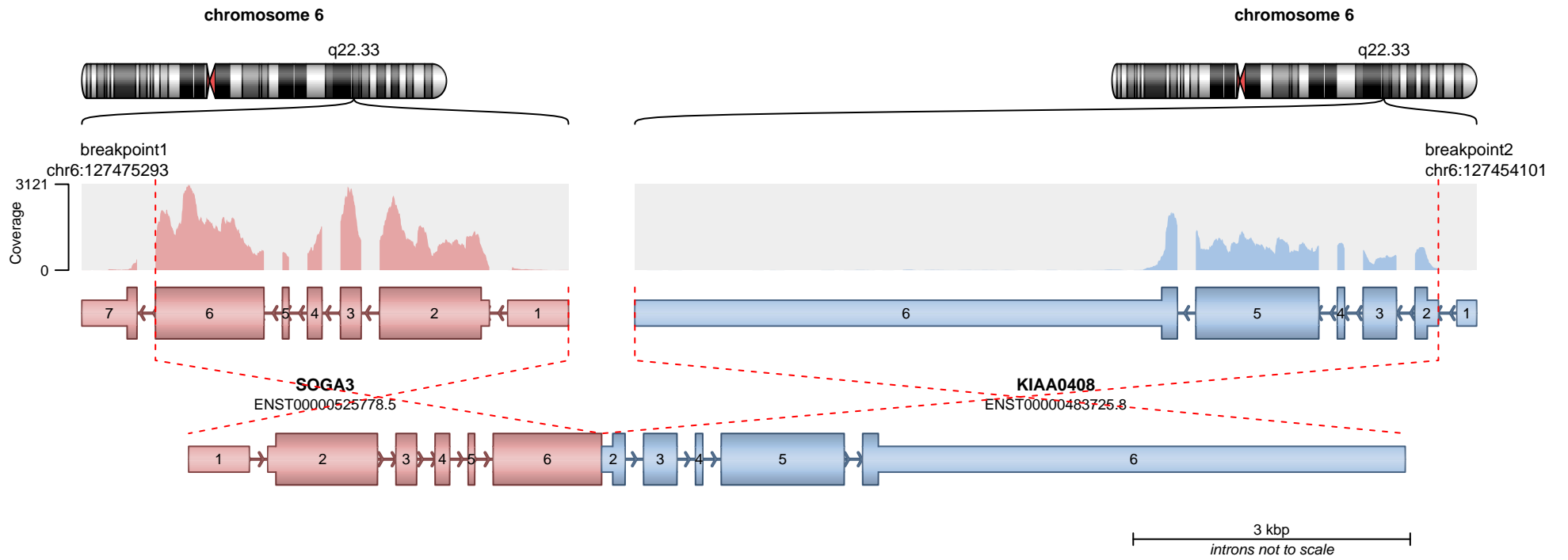

**SUPPORTING READ COUNT**

Split reads = 1  
Discordant mates = 0

- translocation
- duplication
- deletion
- inversion

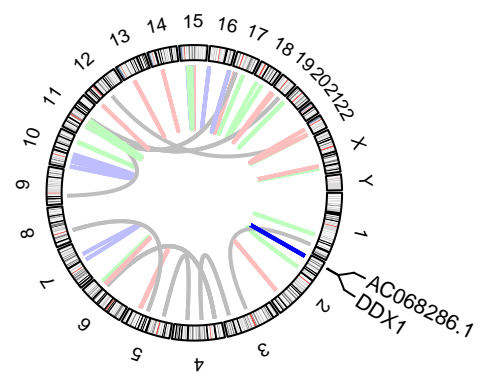
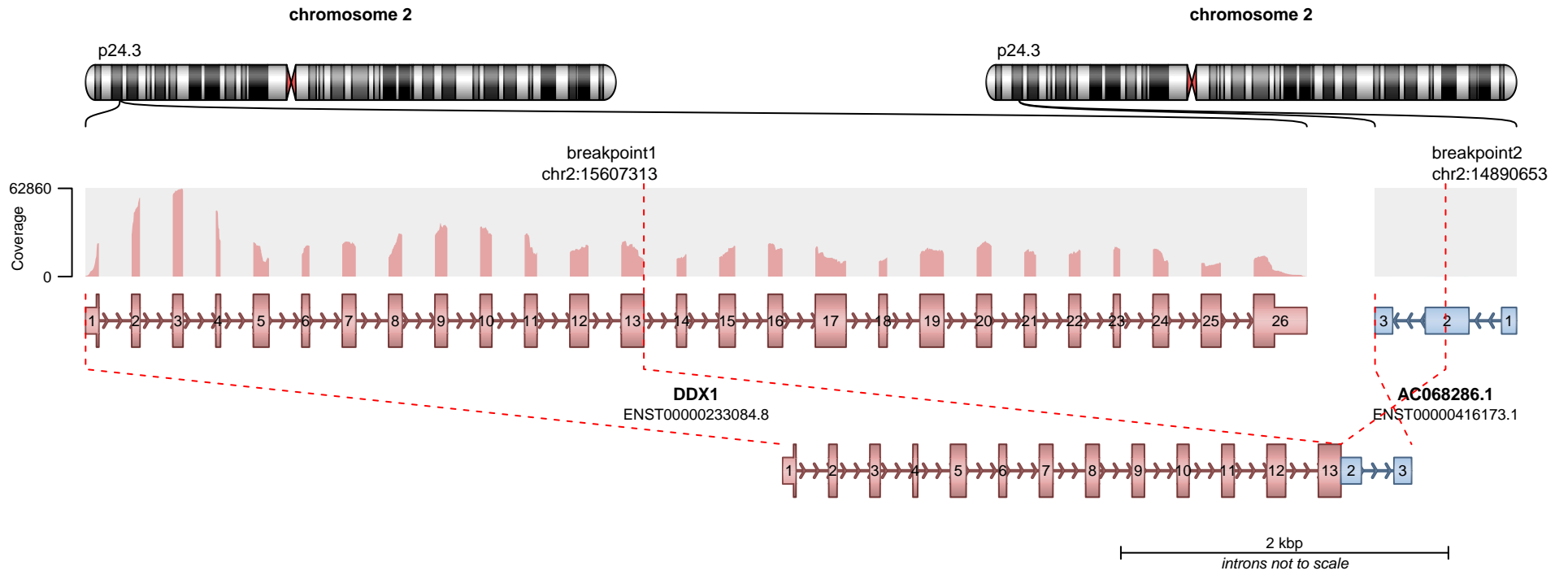

**RETAINED PROTEIN DOMAINS**  
reading frame unclear

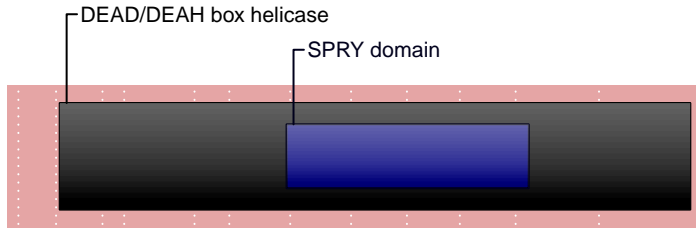

**SUPPORTING READ COUNT**

Split reads = 15  
Discordant mates = 0

- translocation
- duplication
- deletion
- inversion

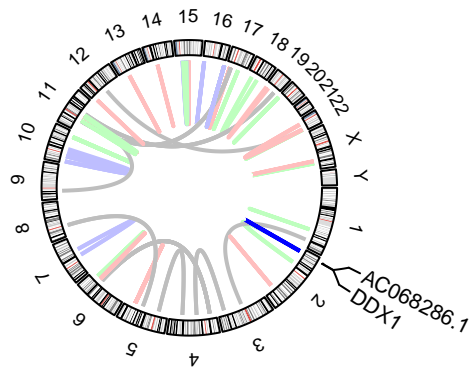
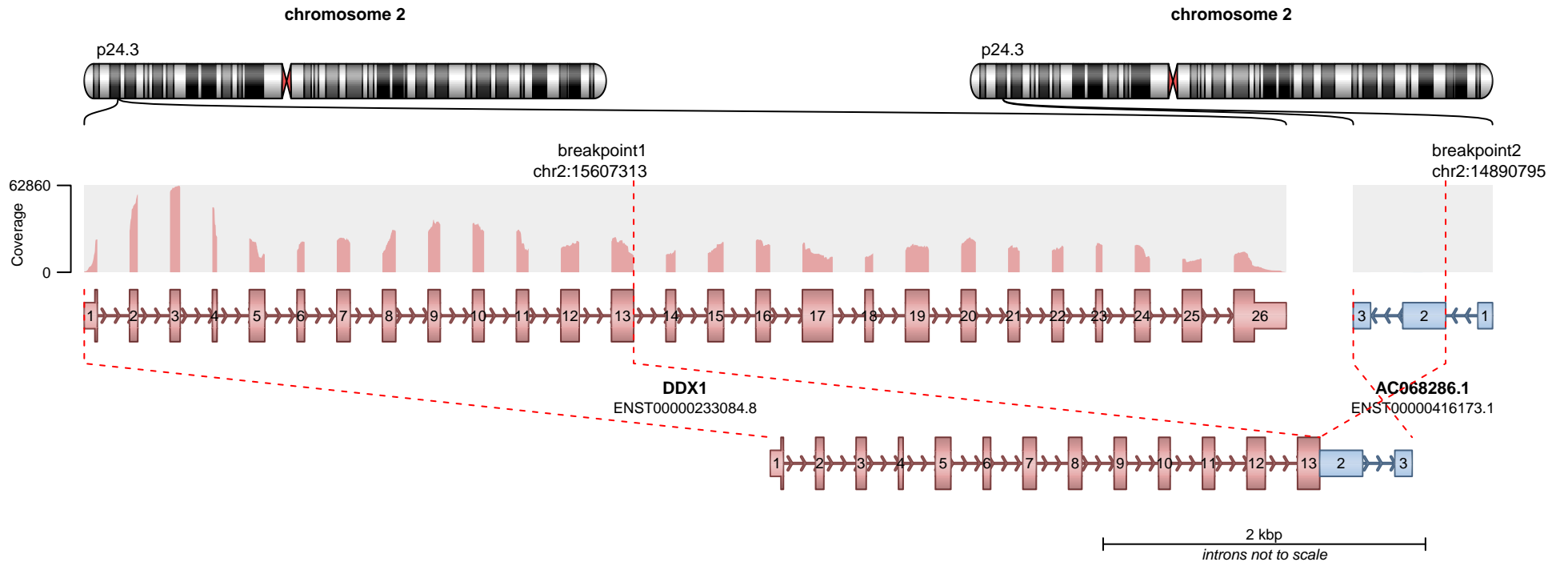

**RETAINED PROTEIN DOMAINS**  
reading frame unclear

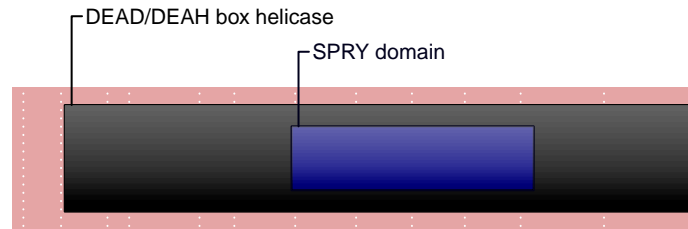

**SUPPORTING READ COUNT**

Split reads = 10  
Discordant mates = 1

- translocation
- duplication
- deletion
- inversion

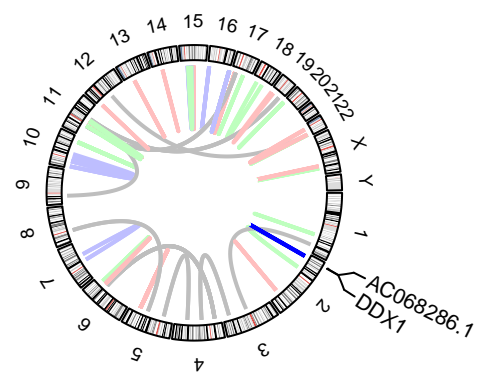
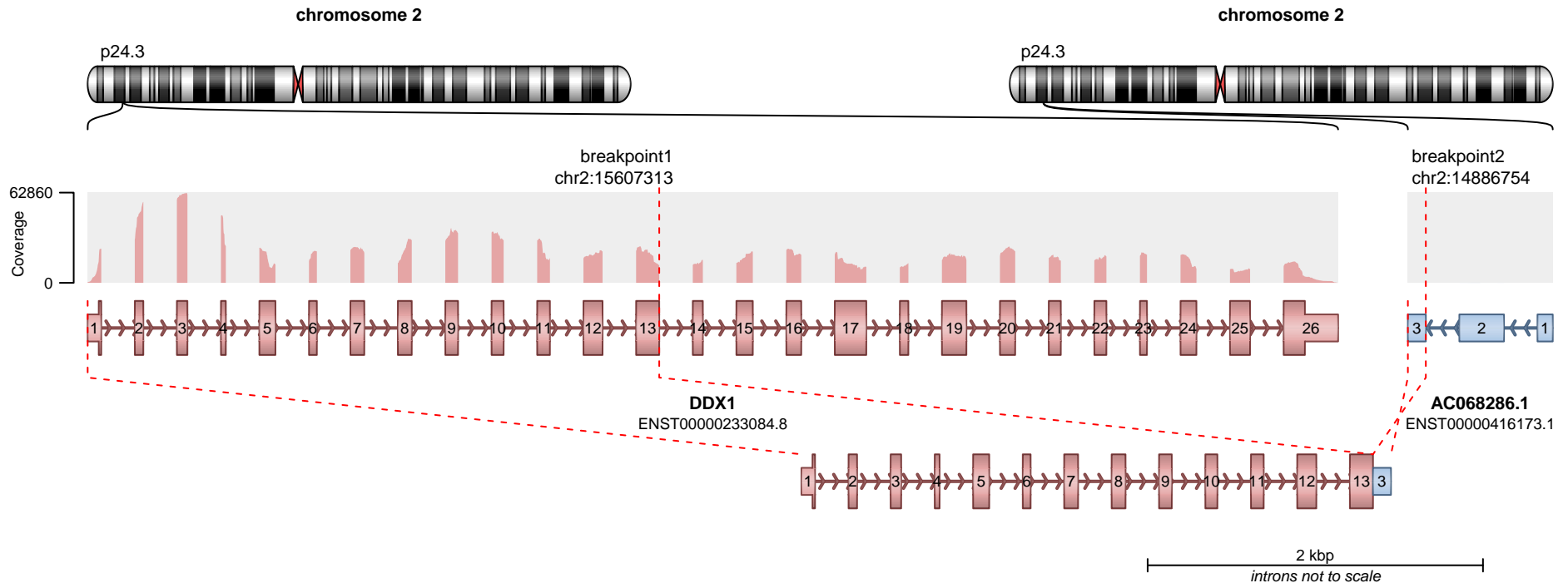

**RETAINED PROTEIN DOMAINS**  
reading frame unclear

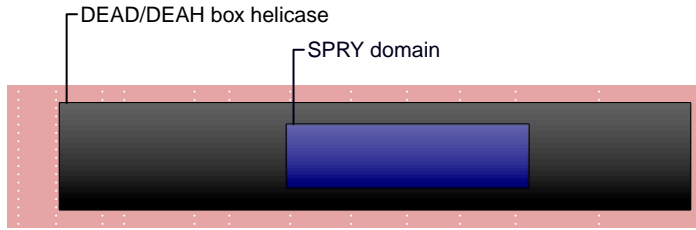

**SUPPORTING READ COUNT**

Split reads = 9  
Discordant mates = 0

- translocation
- duplication
- deletion
- inversion

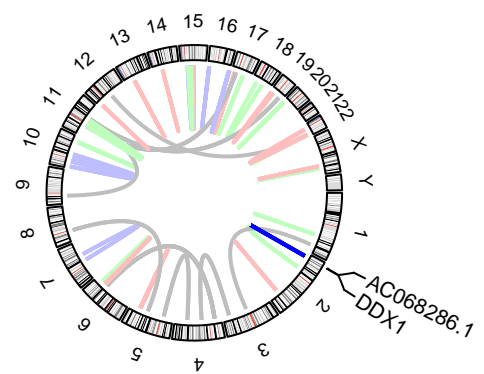
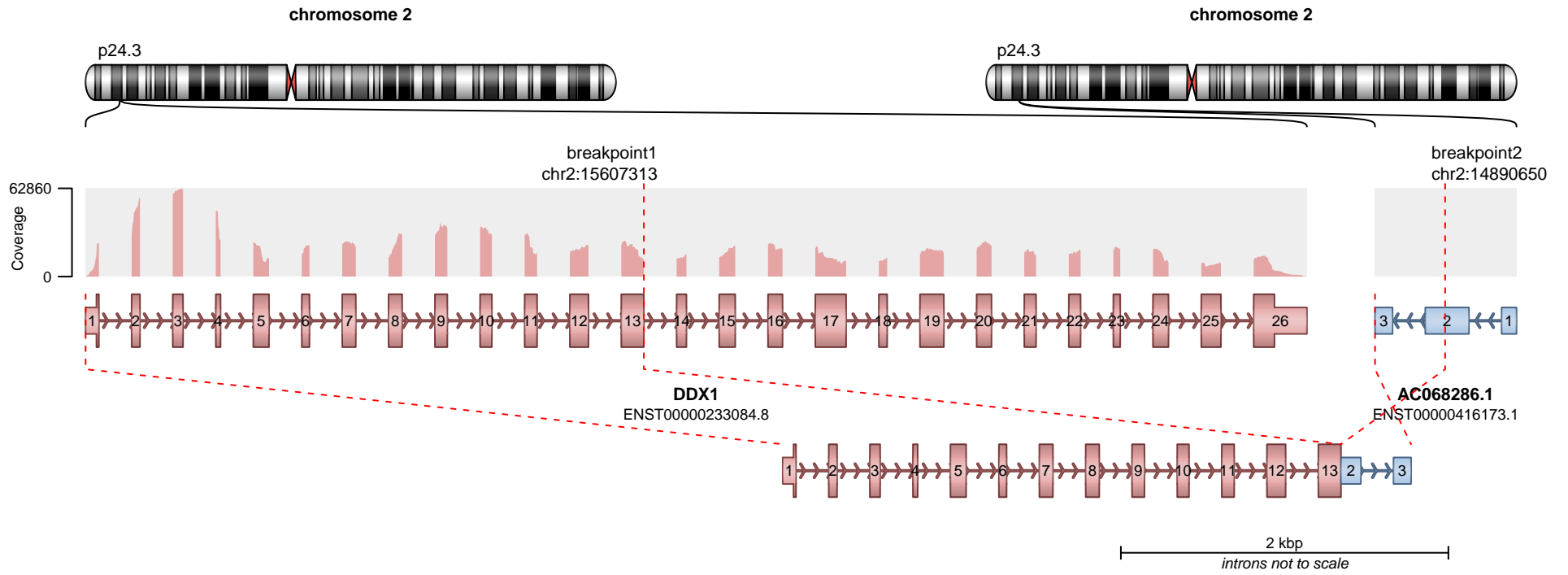

**RETAINED PROTEIN DOMAINS**  
reading frame unclear

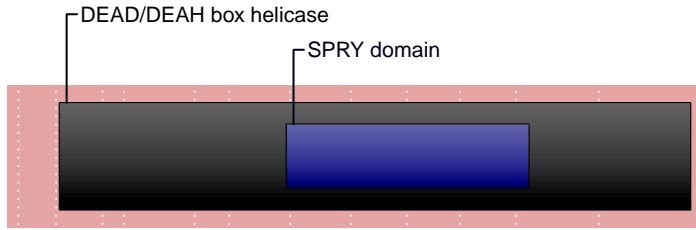

**DDX1**

**SUPPORTING READ COUNT**

Split reads = 7  
Discordant mates = 0

- translocation
- duplication
- deletion
- inversion

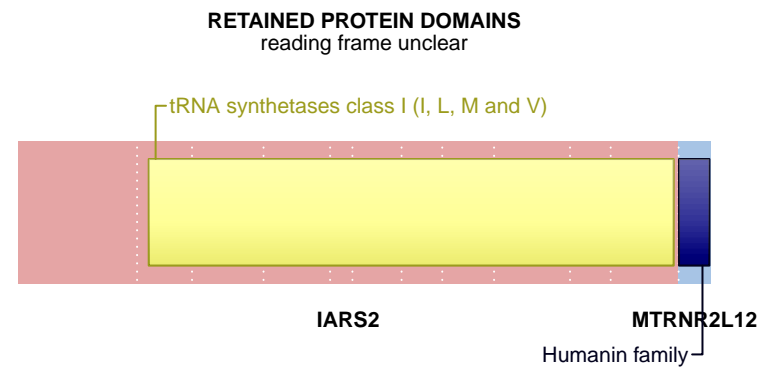
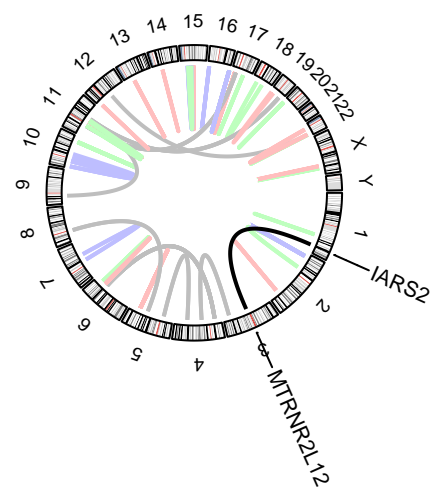
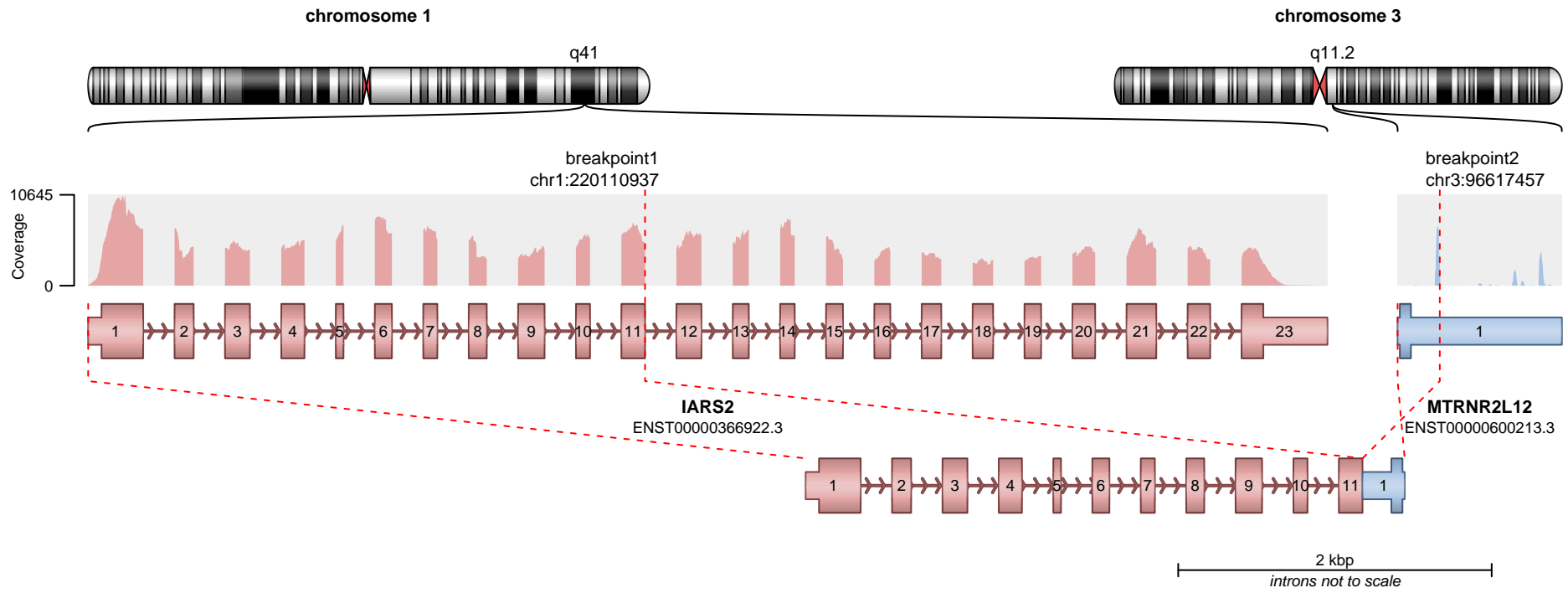

**SUPPORTING READ COUNT**  
Split reads = 15  
Discordant mates = 0

— translocation    — deletion  
— duplication    — inversion

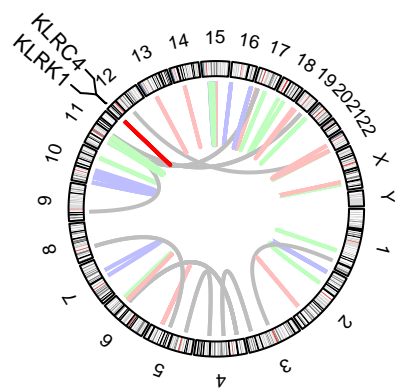
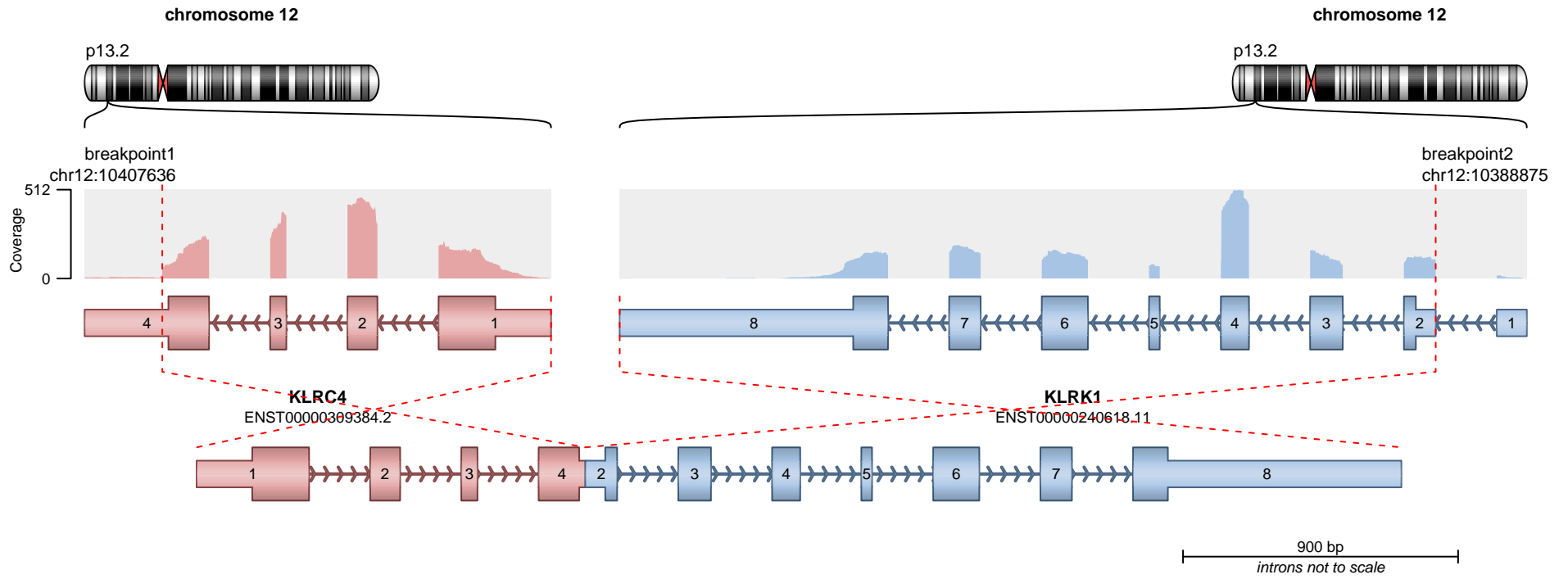

**RETAINED PROTEIN DOMAINS**  
reading frame unclear

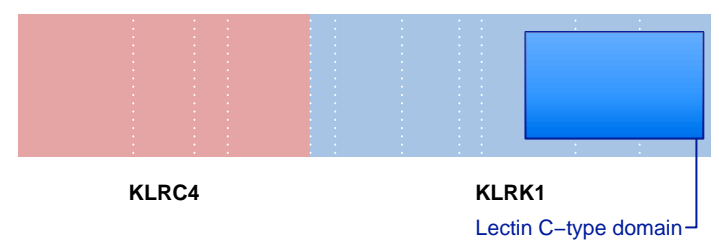

**SUPPORTING READ COUNT**

Split reads = 15  
Discordant mates = 0

— translocation    — deletion  
— duplication    — inversion

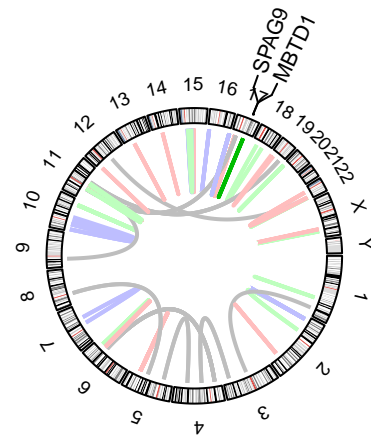
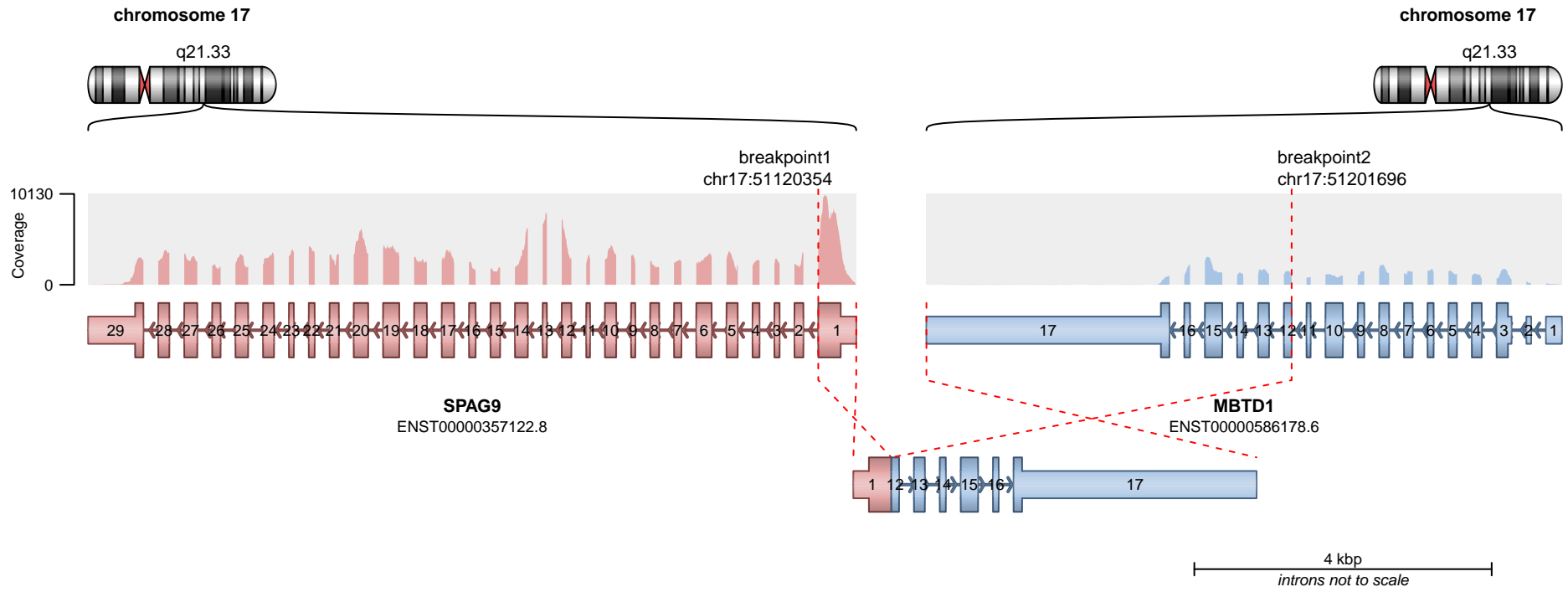

**RETAINED PROTEIN DOMAINS**  
reading frame unclear

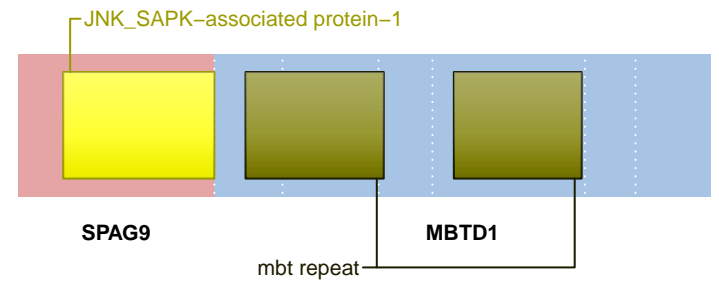

**SUPPORTING READ COUNT**

Split reads = 15  
Discordant mates = 0

- translocation
- duplication
- deletion
- inversion

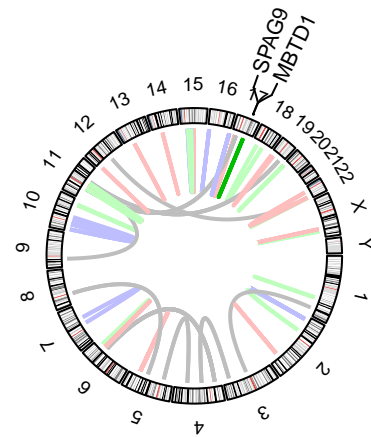
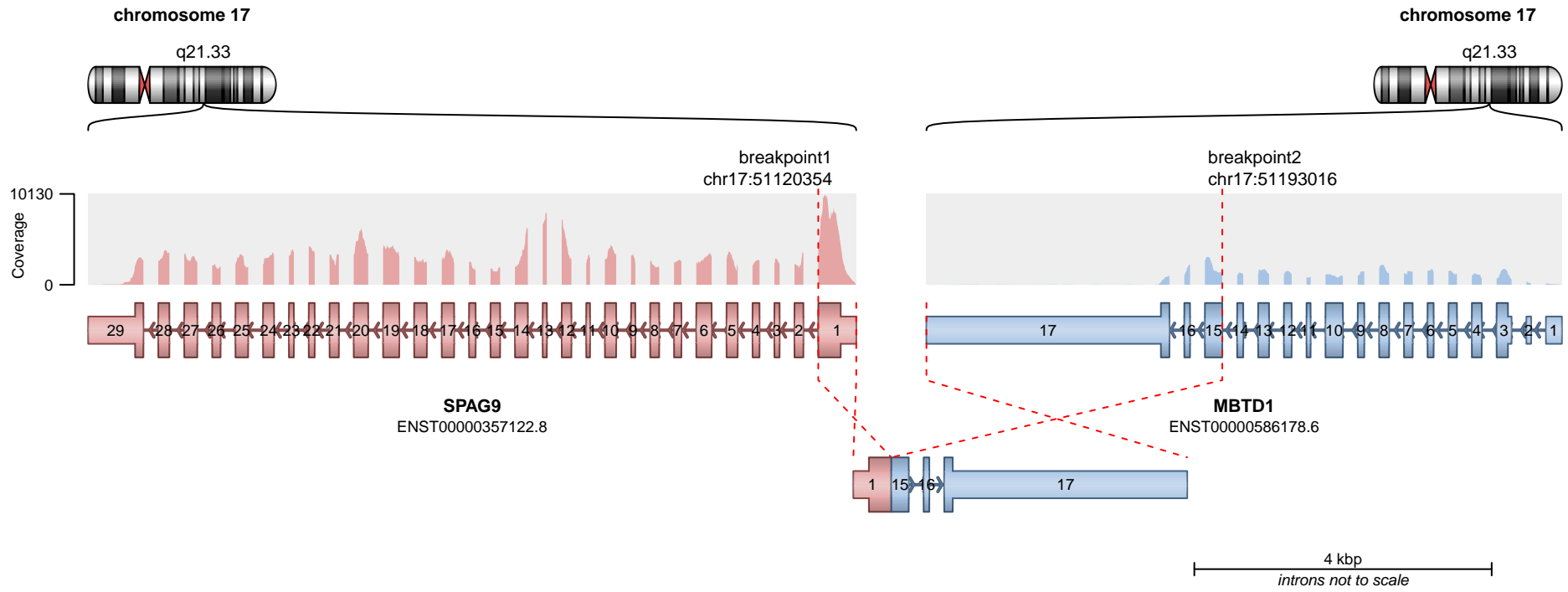

**RETAINED PROTEIN DOMAINS**  
reading frame unclear

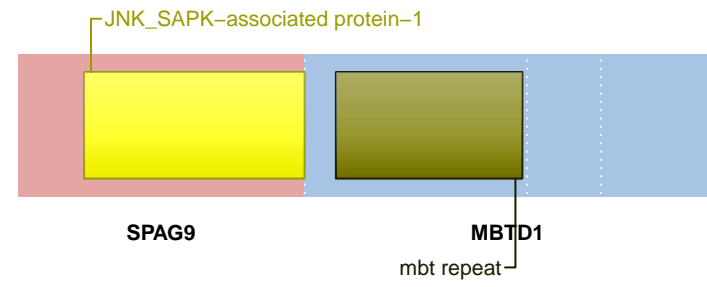

**SUPPORTING READ COUNT**

Split reads = 2  
Discordant mates = 0

- translocation
- duplication
- deletion
- inversion

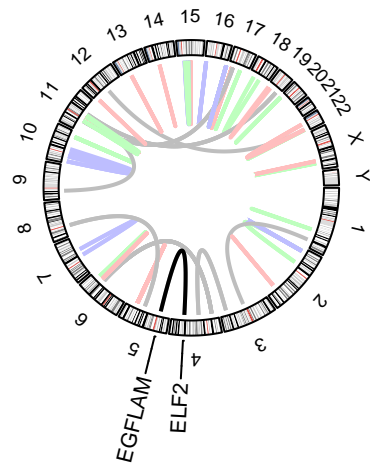
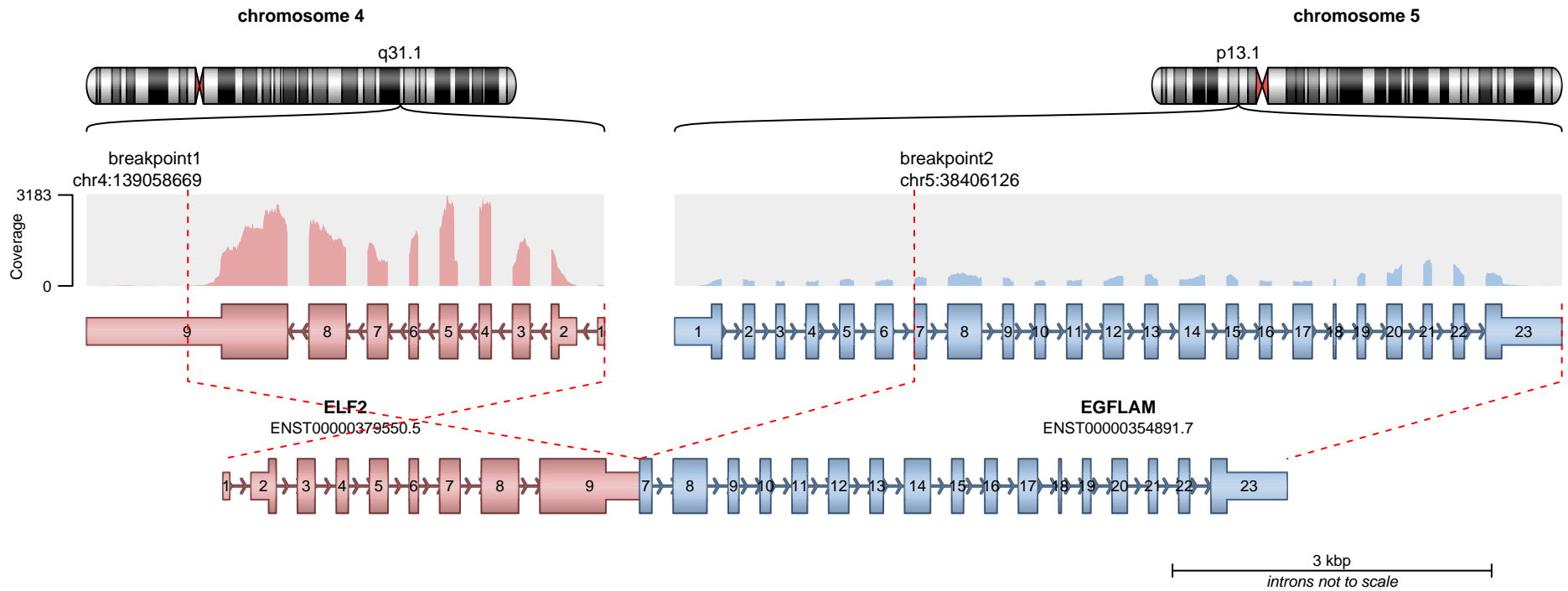

— translocation — deletion  
— duplication — inversion

**RETAINED PROTEIN DOMAINS**  
reading frame unclear

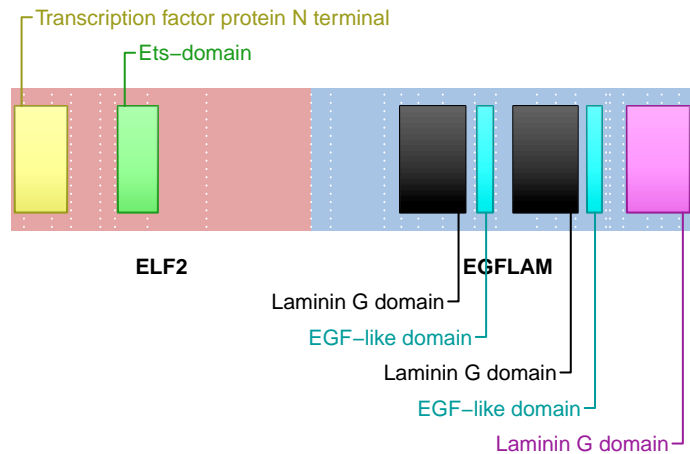

**SUPPORTING READ COUNT**

Split reads = 13  
Discordant mates = 0

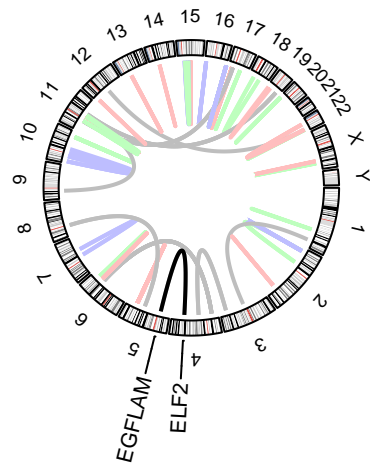
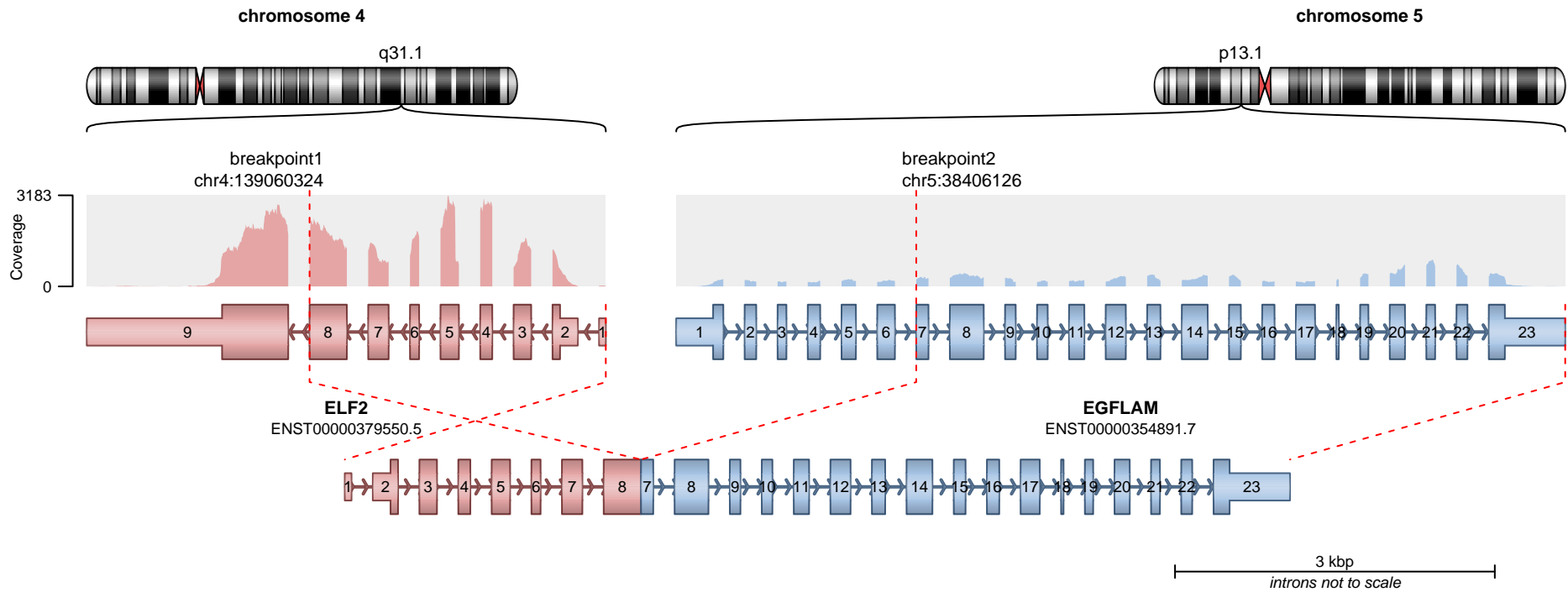

— translocation — deletion  
— duplication — inversion

**RETAINED PROTEIN DOMAINS**  
reading frame unclear

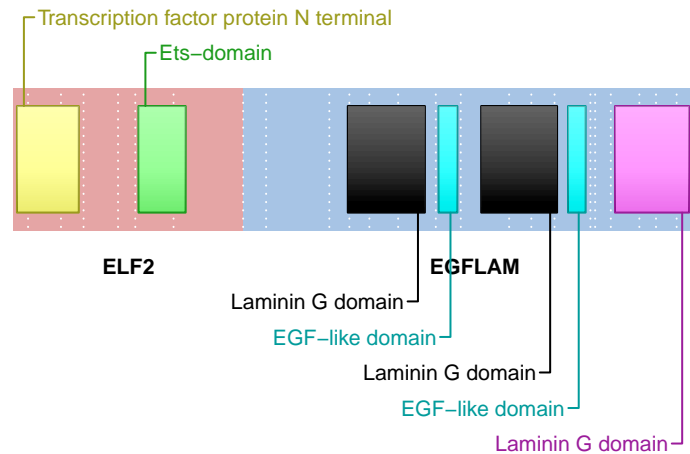

**SUPPORTING READ COUNT**

Split reads = 7  
Discordant mates = 0

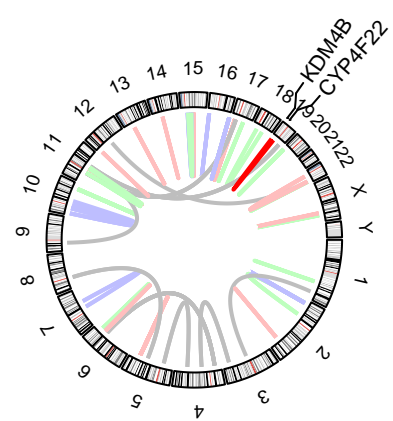
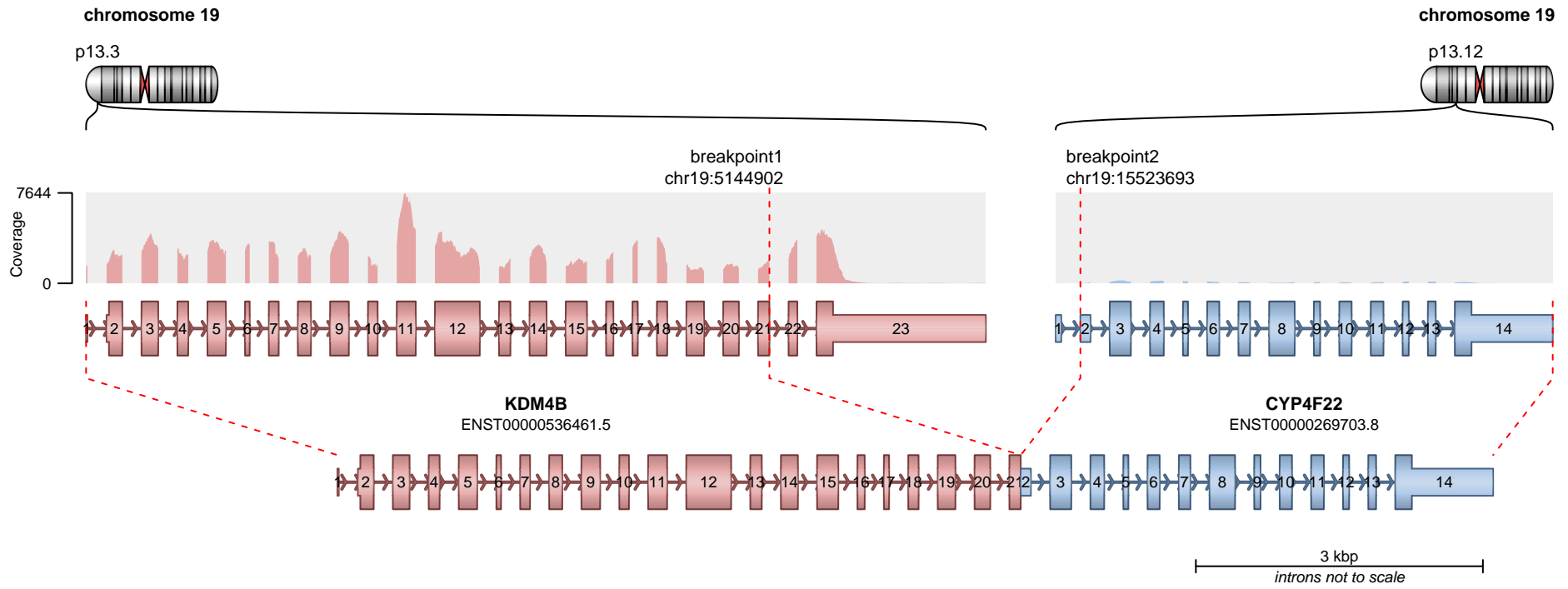

**RETAINED PROTEIN DOMAINS**  
reading frame unclear

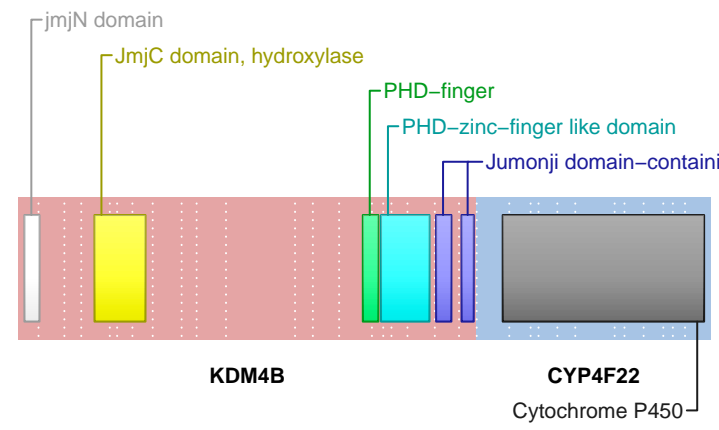

**SUPPORTING READ COUNT**

Split reads = 13  
Discordant mates = 0

- translocation
- duplication
- deletion
- inversion

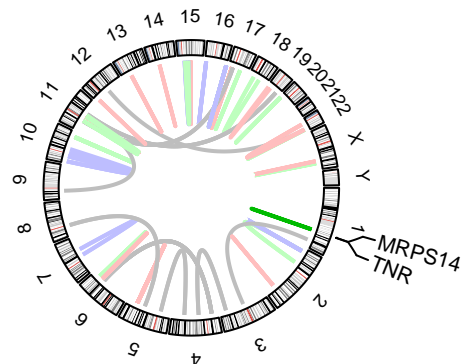
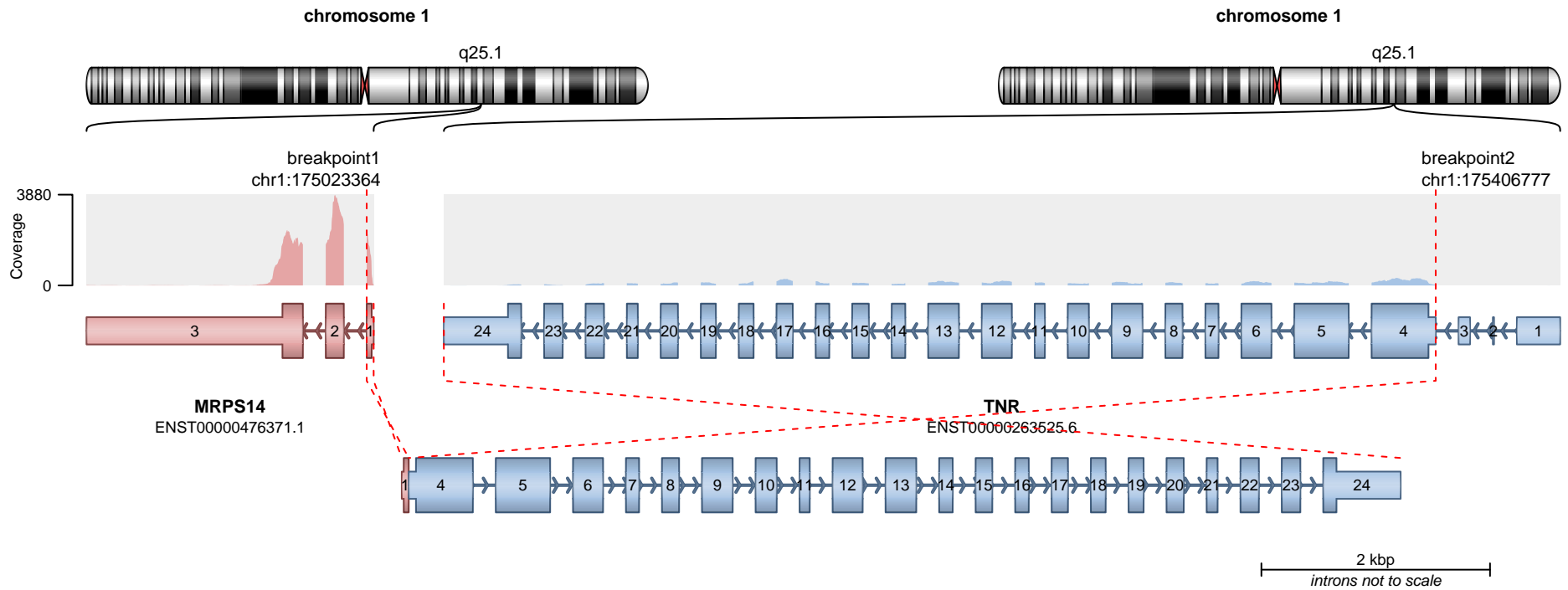

— translocation — deletion  
— duplication — inversion

**RETAINED PROTEIN DOMAINS**  
reading frame unclear

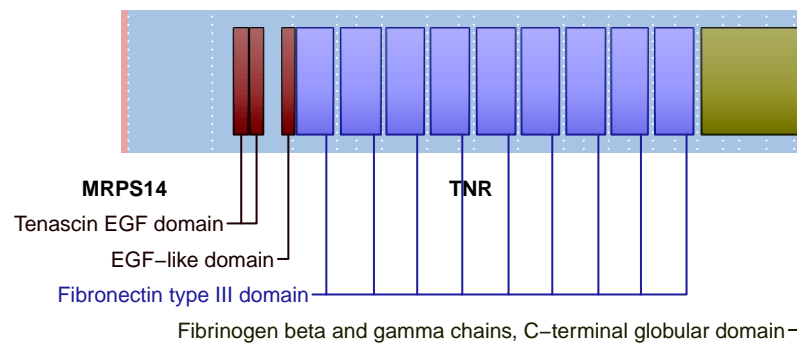

**SUPPORTING READ COUNT**

Split reads = 12  
Discordant mates = 0

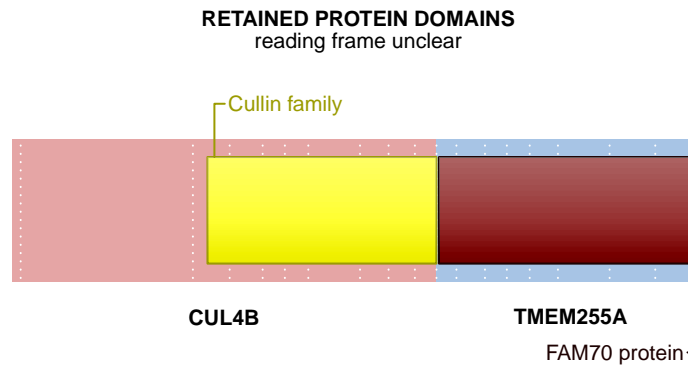
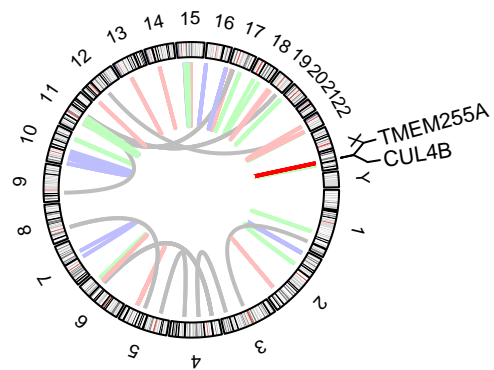
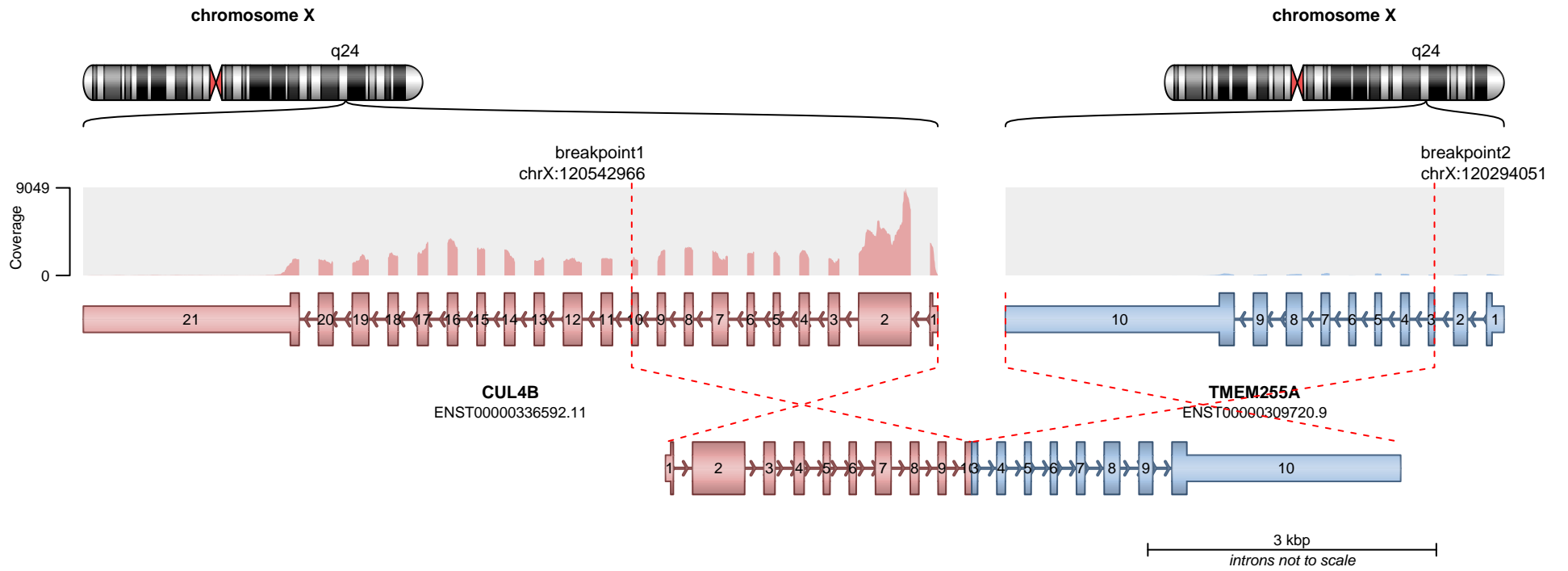

**SUPPORTING READ COUNT**

Split reads = 11  
Discordant mates = 0

— translocation — deletion  
— duplication — inversion

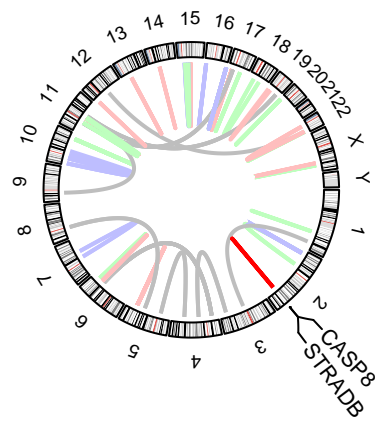
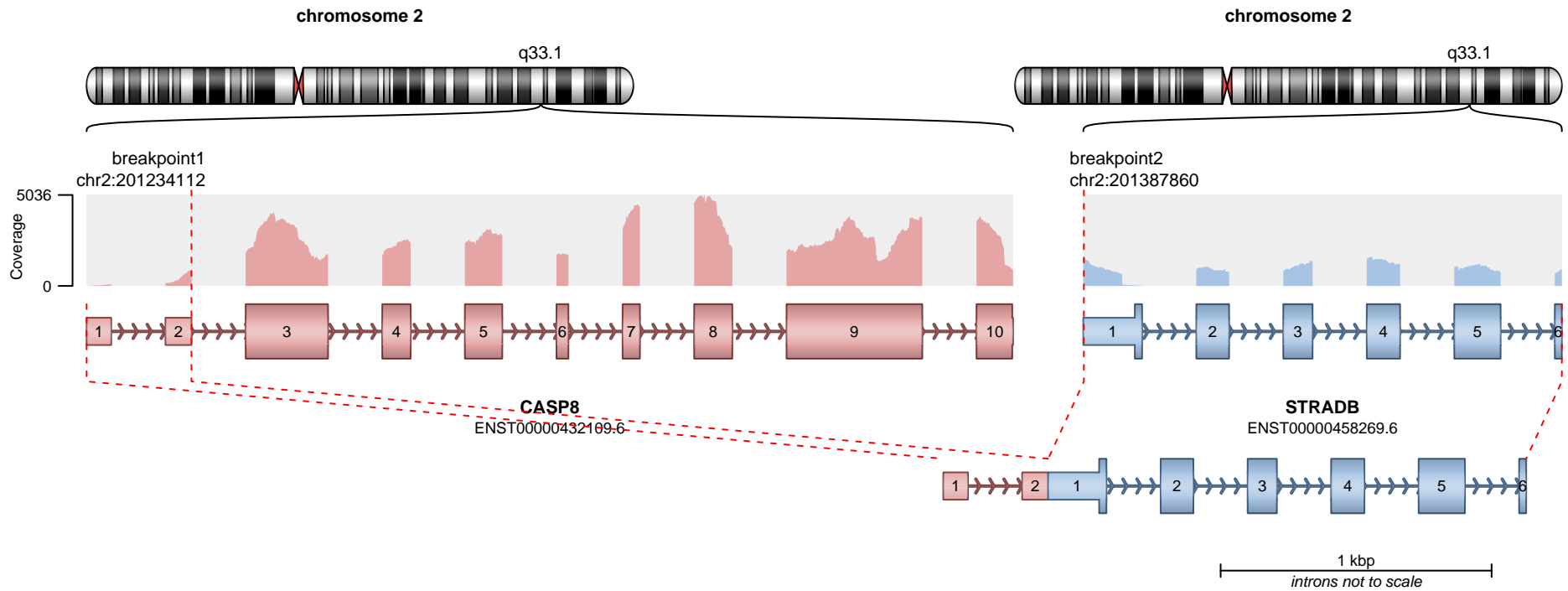

**RETAINED PROTEIN DOMAINS**  
reading frame unclear

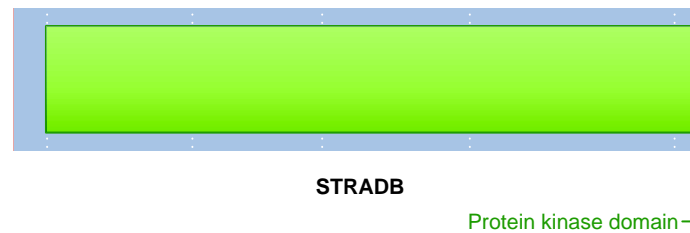

**SUPPORTING READ COUNT**

Split reads = 10  
Discordant mates = 1

— translocation — deletion  
— duplication — inversion

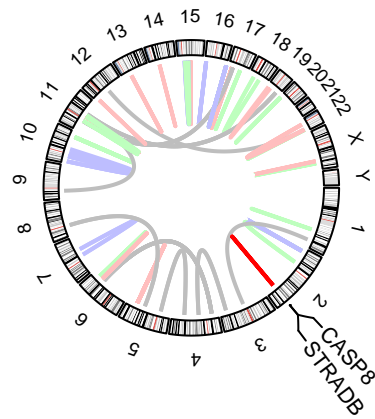
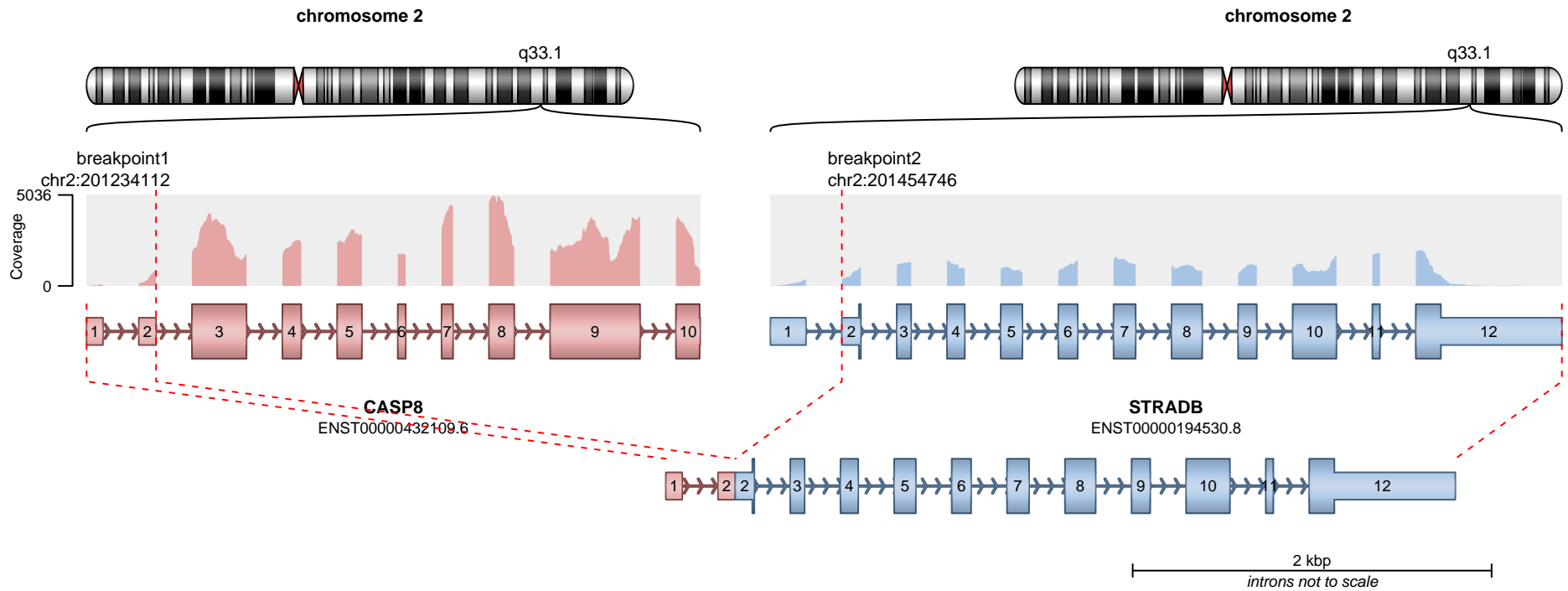

— translocation — deletion  
— duplication — inversion

**RETAINED PROTEIN DOMAINS**  
reading frame unclear

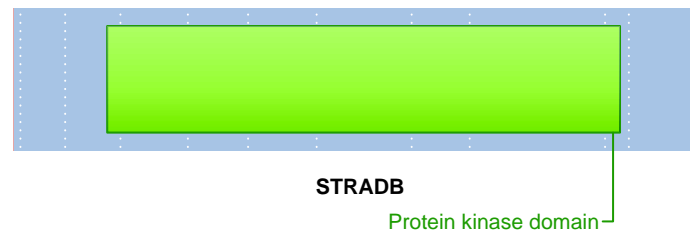

**SUPPORTING READ COUNT**

Split reads = 2  
Discordant mates = 0

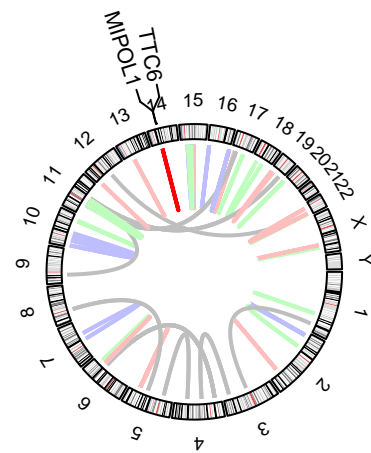
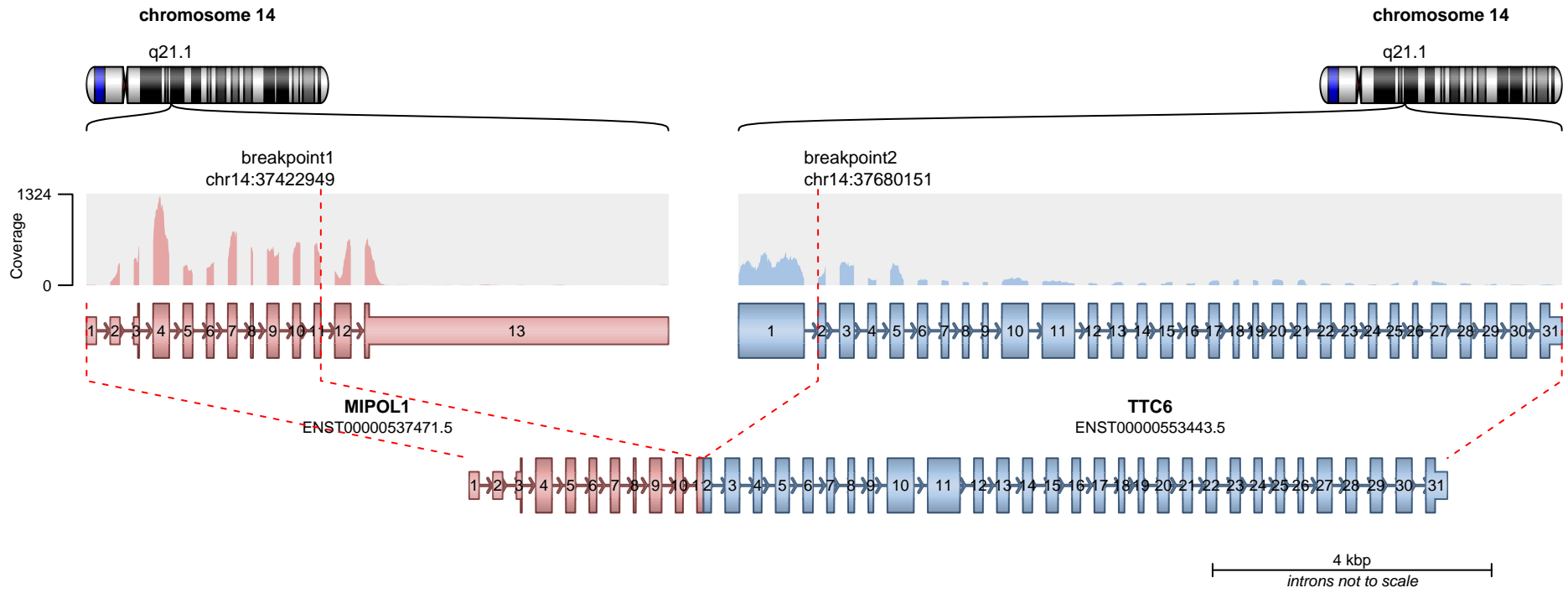

— translocation — deletion  
— duplication — inversion

**RETAINED PROTEIN DOMAINS**  
reading frame unclear

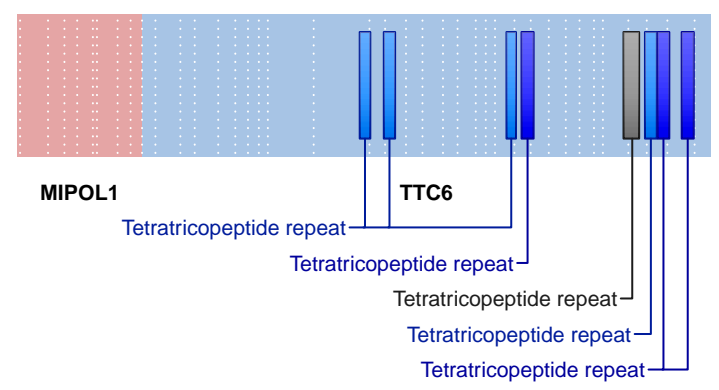

**SUPPORTING READ COUNT**

Split reads = 9  
Discordant mates = 0

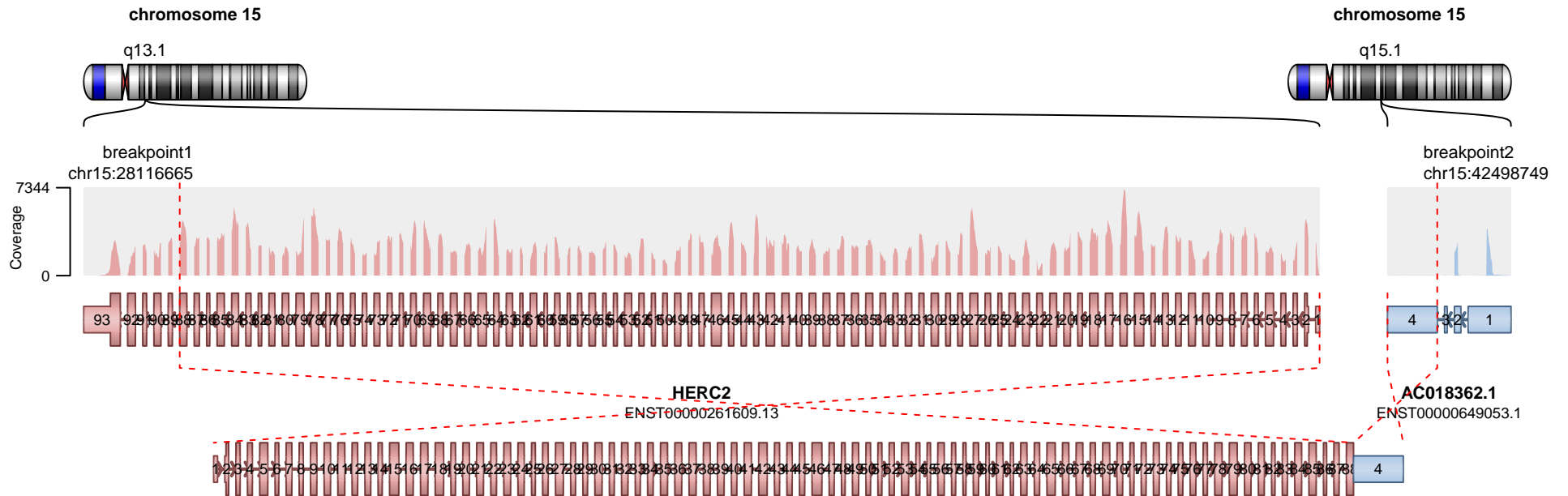

**RETAINED PROTEIN DOMAINS**  
reading frame unclear

7 kbp  
introns not to scale

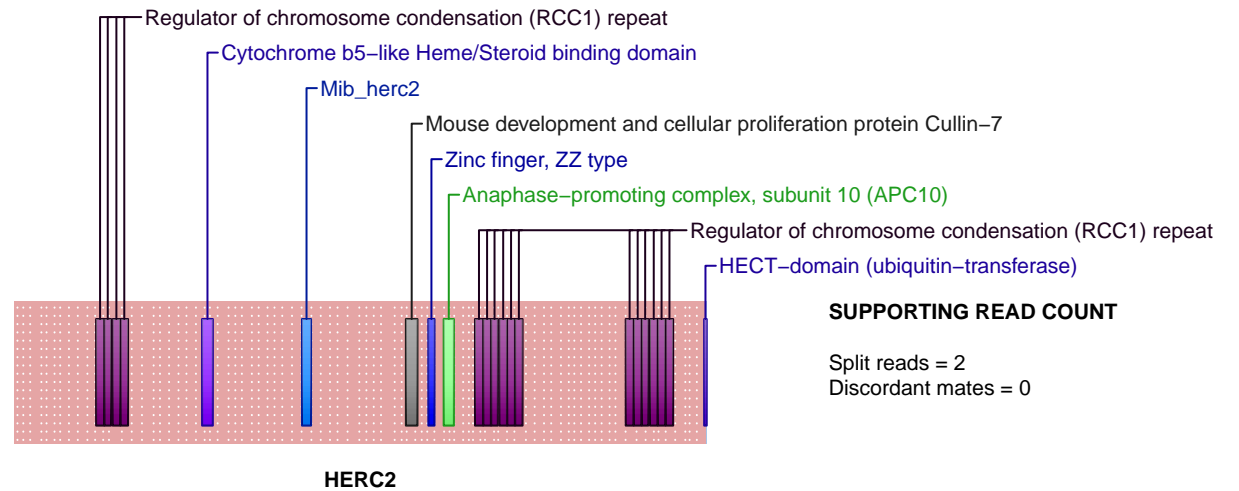
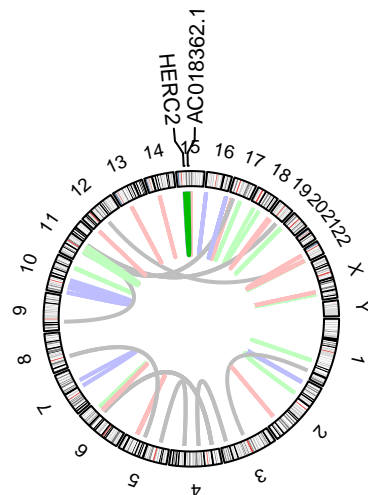

— translocation — deletion  
— duplication — inversion