

RETAINED PROTEIN DOMAINS
reading frame unclear

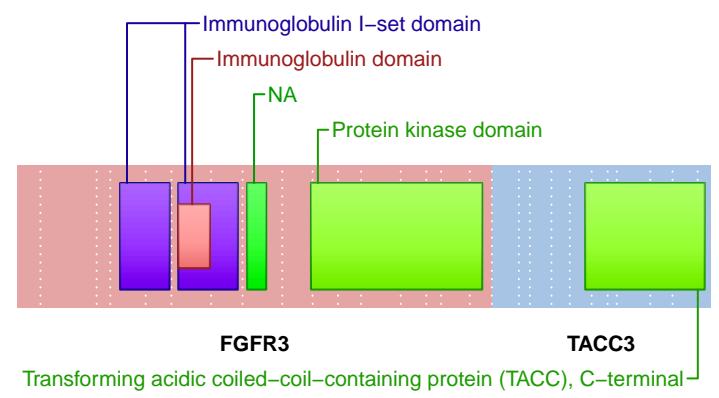

SUPPORTING READ COUNT

Split reads = 33228
Discordant mates = 125

- translocation
- duplication
- deletion
- inversion

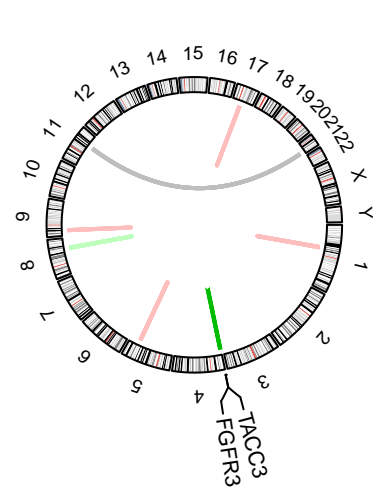
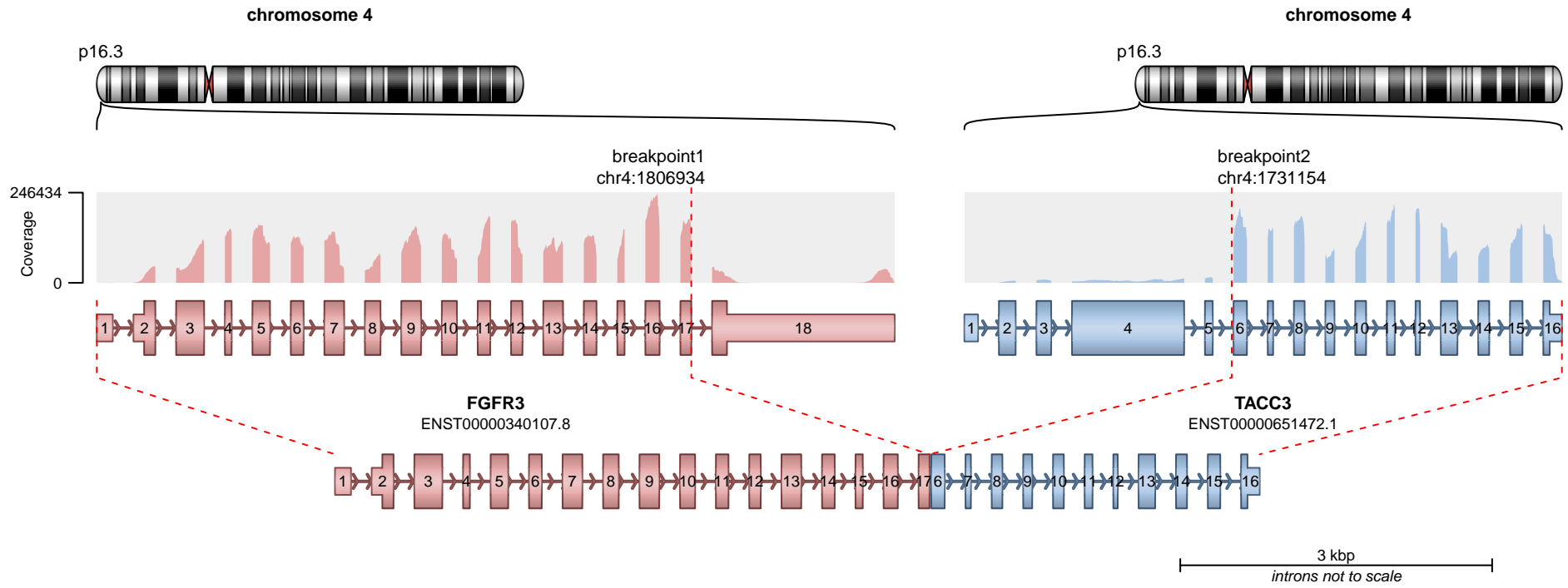

RETAINED PROTEIN DOMAINS
reading frame unclear

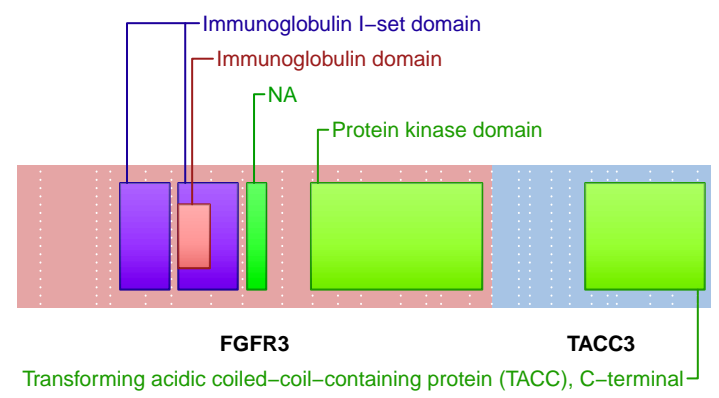

SUPPORTING READ COUNT

Split reads = 2603
Discordant mates = 129

- translocation
- duplication
- deletion
- inversion

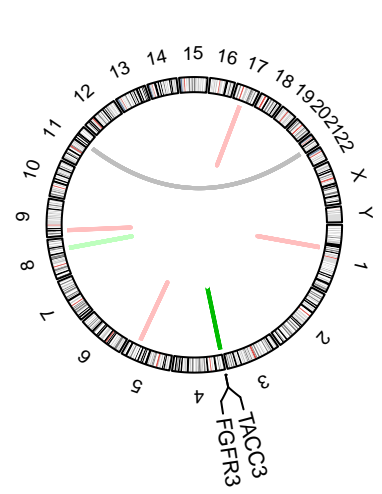
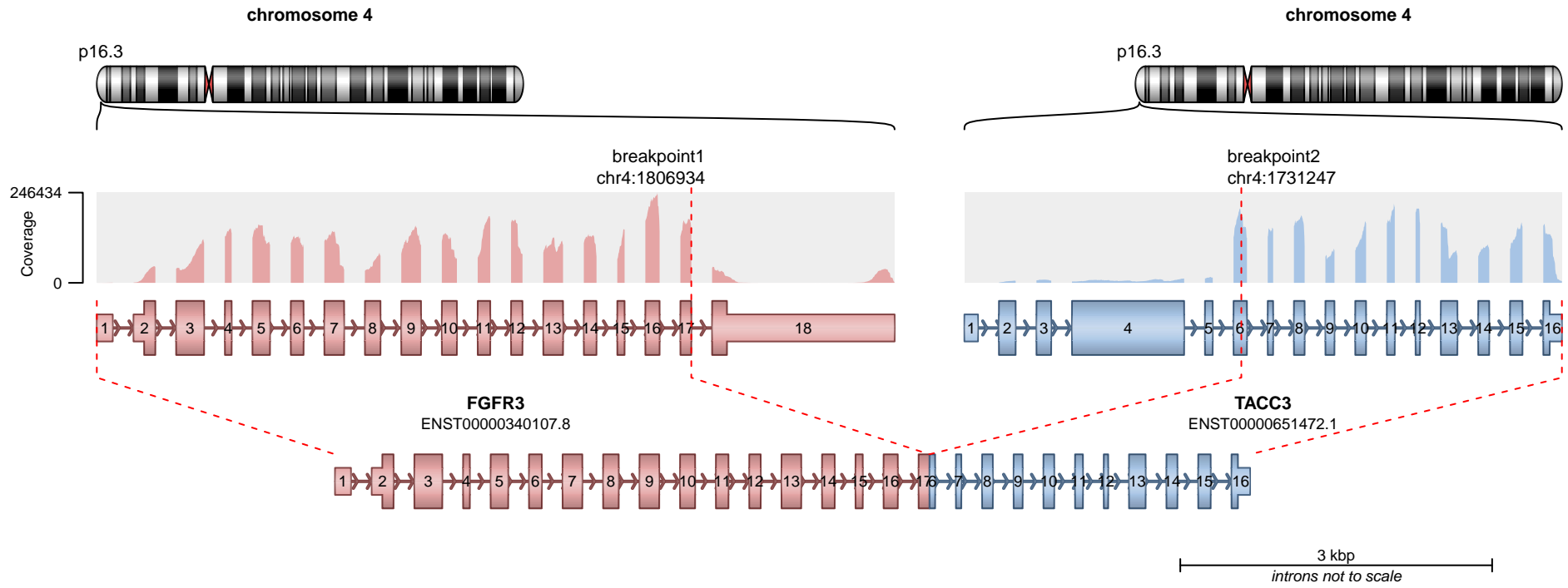

RETAINED PROTEIN DOMAINS
reading frame unclear

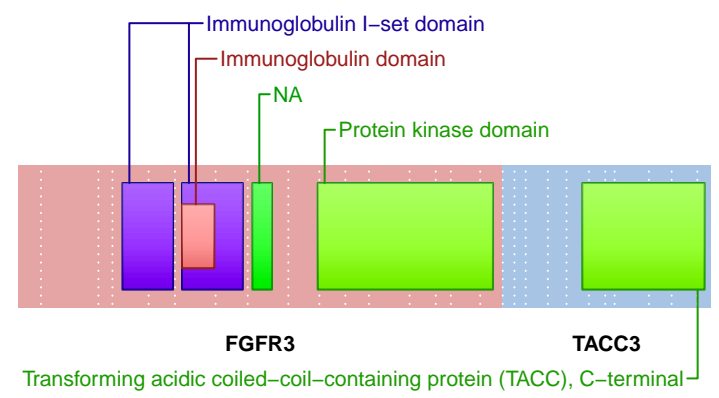

SUPPORTING READ COUNT

Split reads = 151
Discordant mates = 35

- translocation
- duplication
- deletion
- inversion

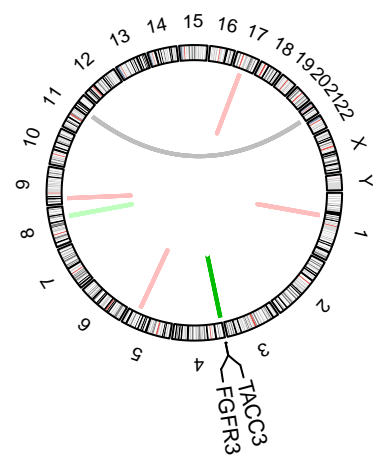
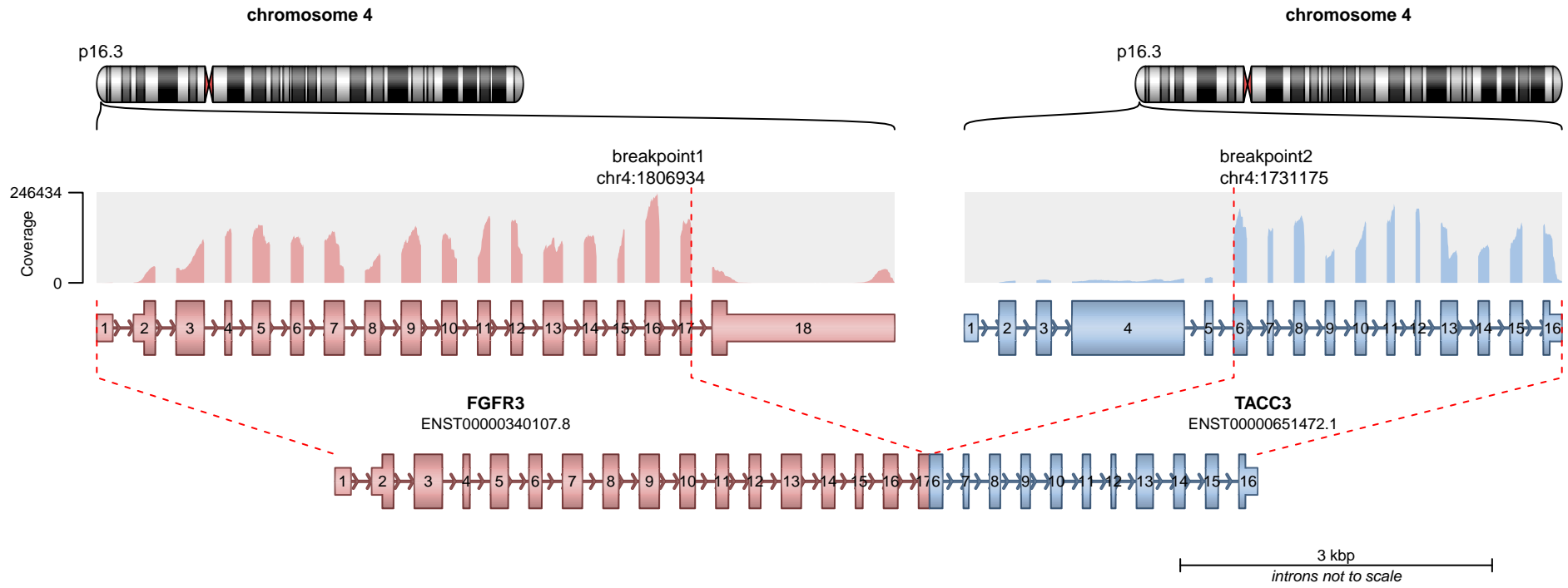

RETAINED PROTEIN DOMAINS
reading frame unclear

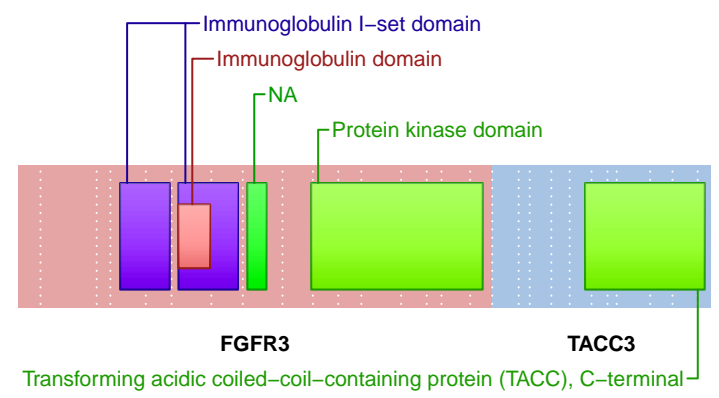

SUPPORTING READ COUNT

Split reads = 66
Discordant mates = 124

- translocation
- duplication
- deletion
- inversion

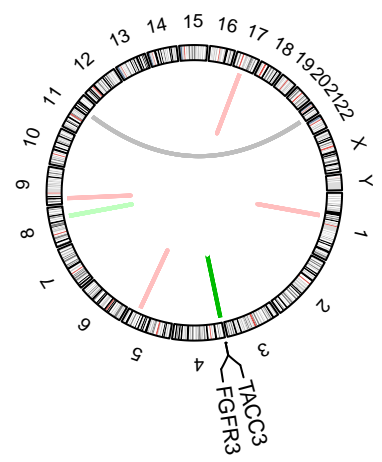
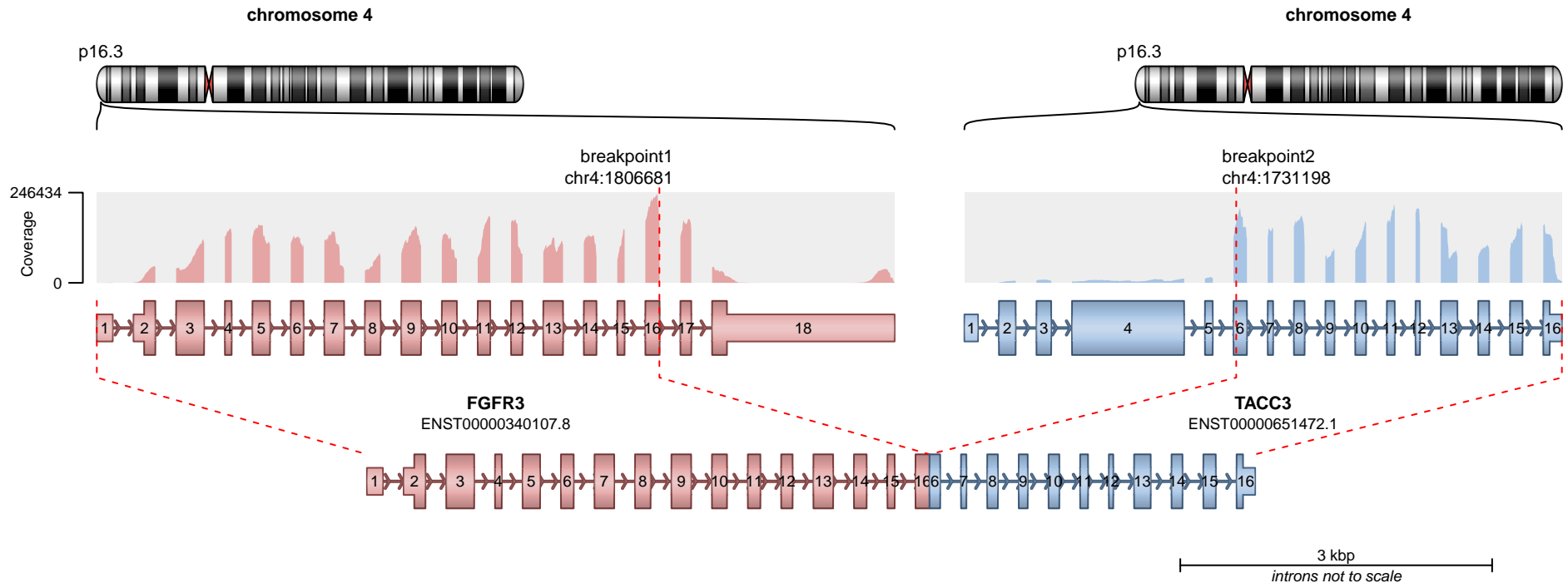

RETAINED PROTEIN DOMAINS
reading frame unclear

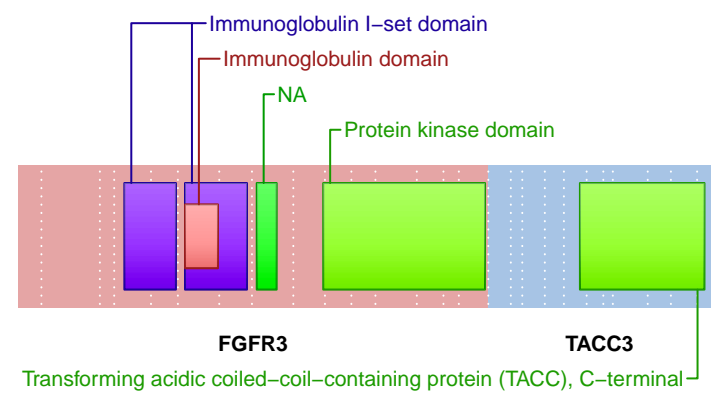

SUPPORTING READ COUNT

Split reads = 69
Discordant mates = 7

- translocation
- duplication
- deletion
- inversion

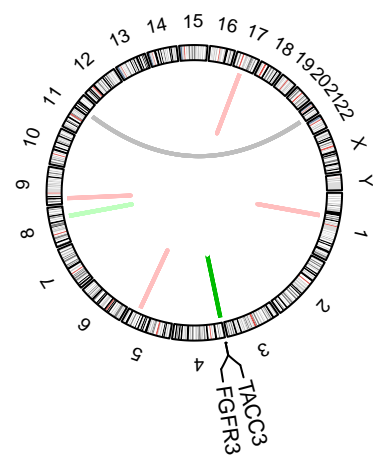
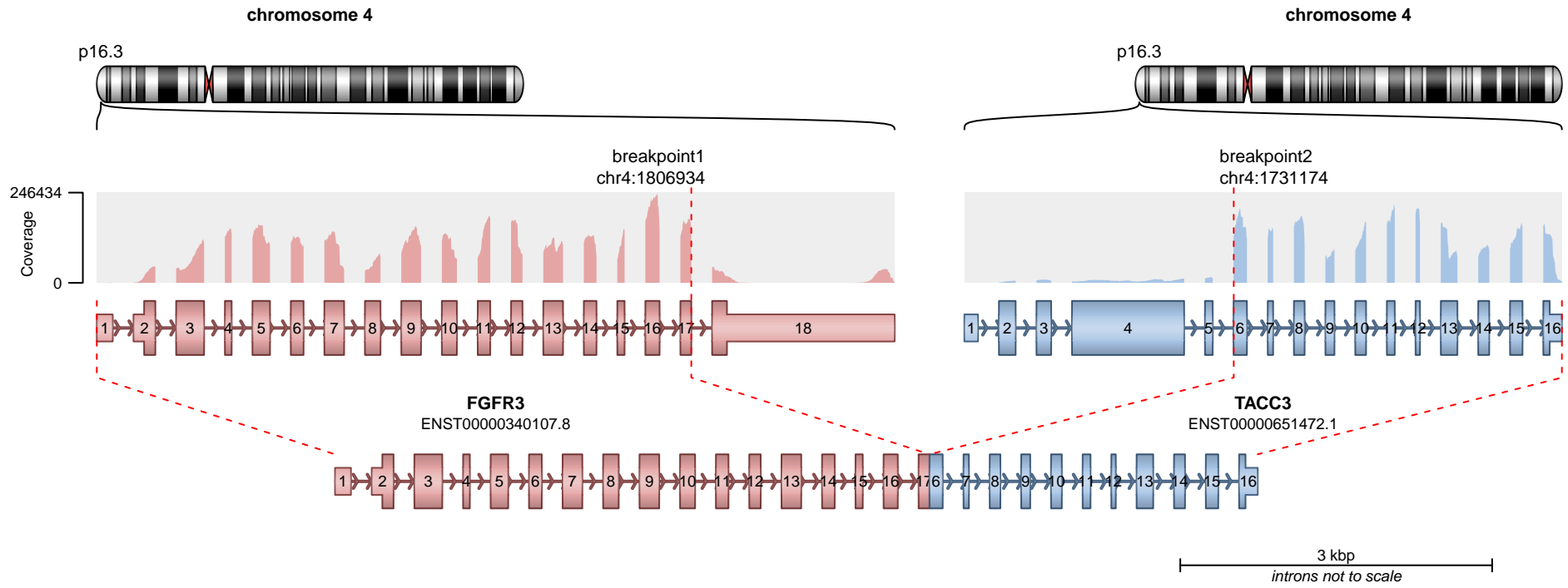

RETAINED PROTEIN DOMAINS
reading frame unclear

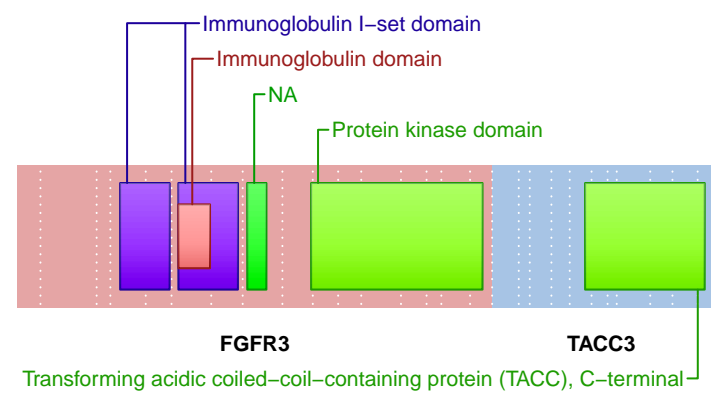

SUPPORTING READ COUNT

Split reads = 25
Discordant mates = 124

- translocation
- duplication
- deletion
- inversion

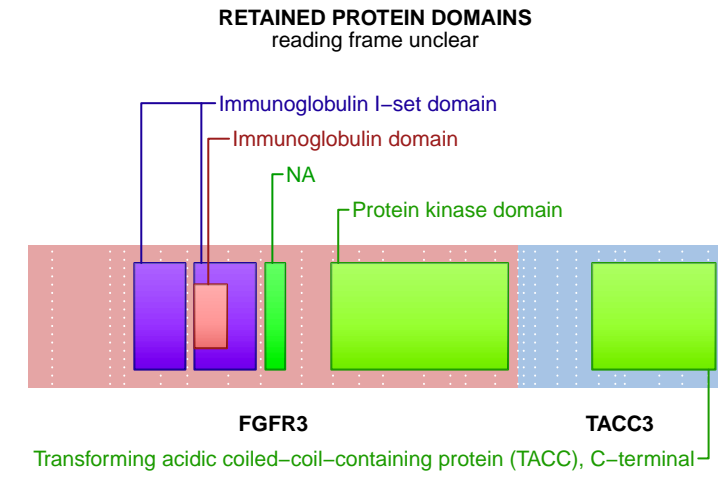
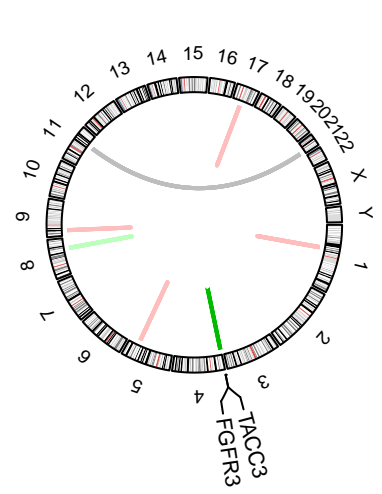
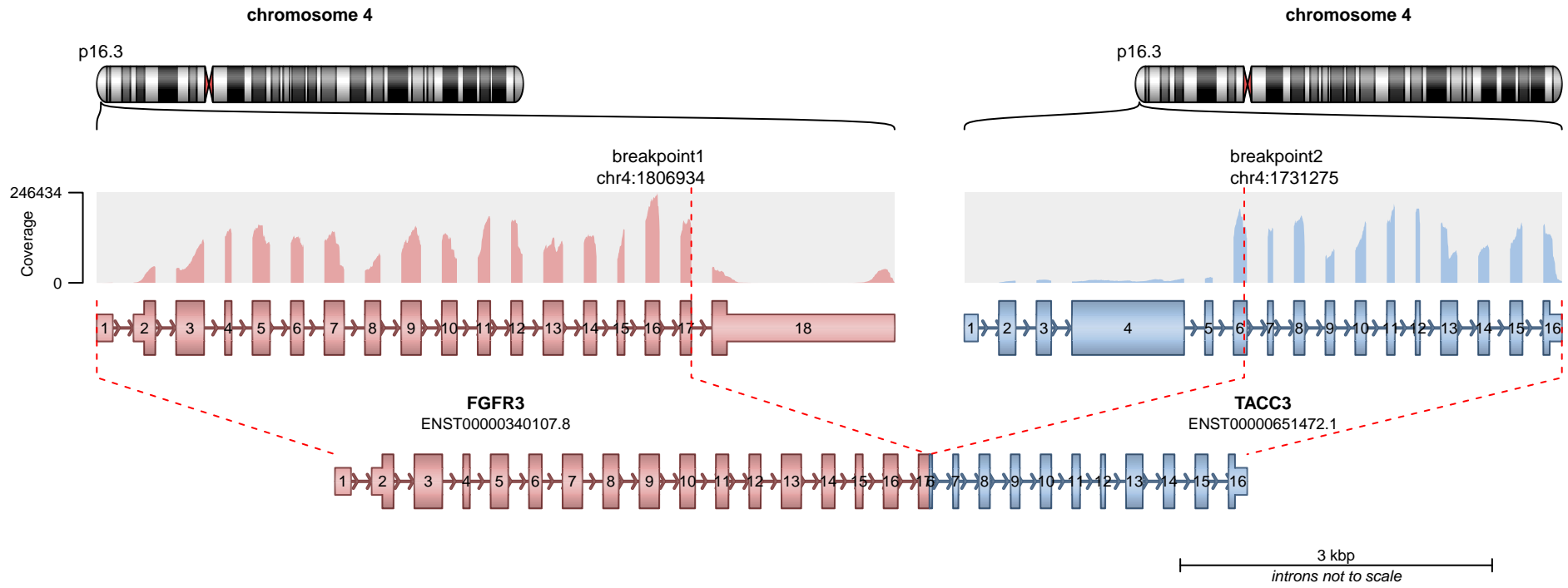

SUPPORTING READ COUNT

Split reads = 26
Discordant mates = 30

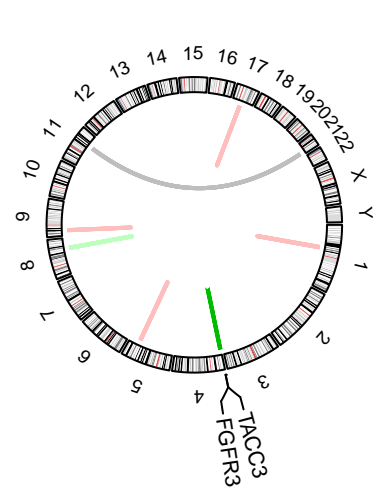
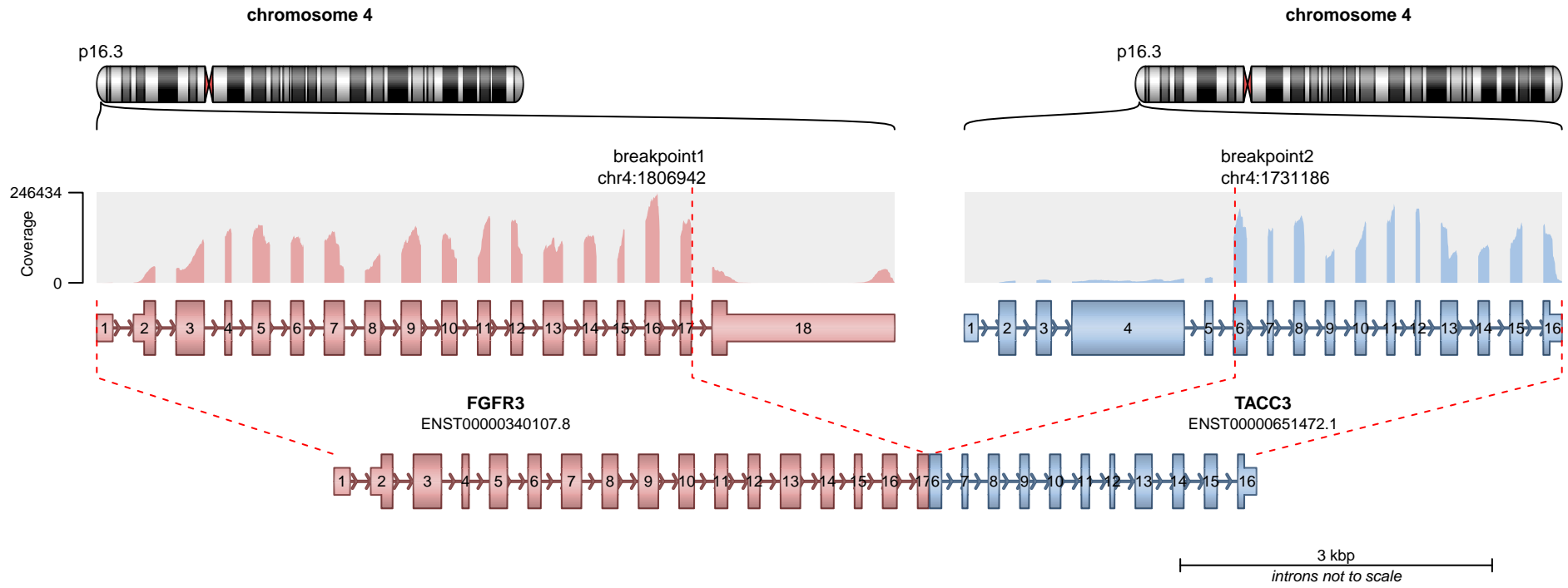

RETAINED PROTEIN DOMAINS
reading frame unclear

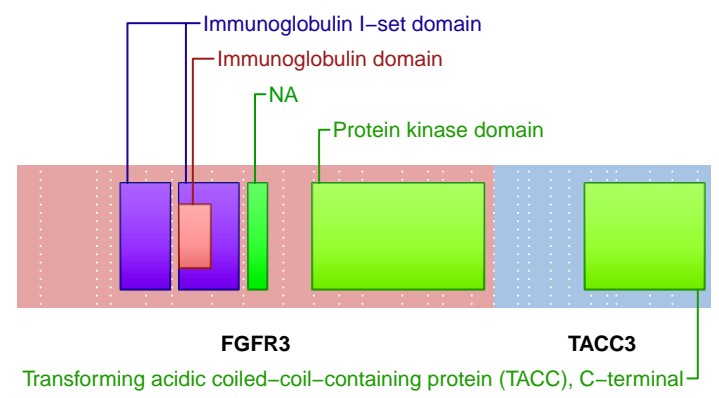

SUPPORTING READ COUNT

Split reads = 5
Discordant mates = 83

- translocation
- duplication
- deletion
- inversion

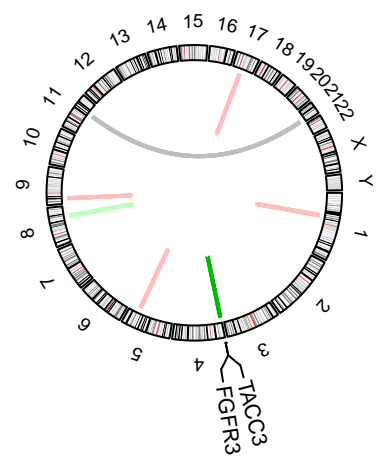
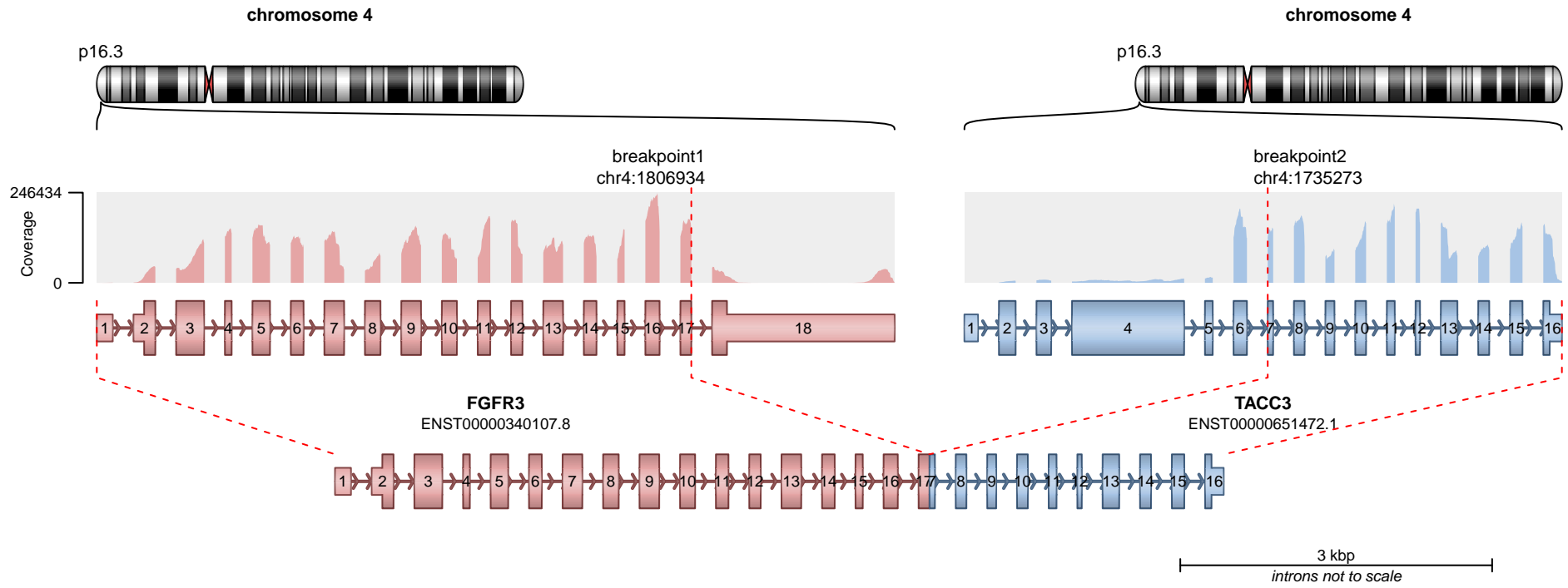

RETAINED PROTEIN DOMAINS
reading frame unclear

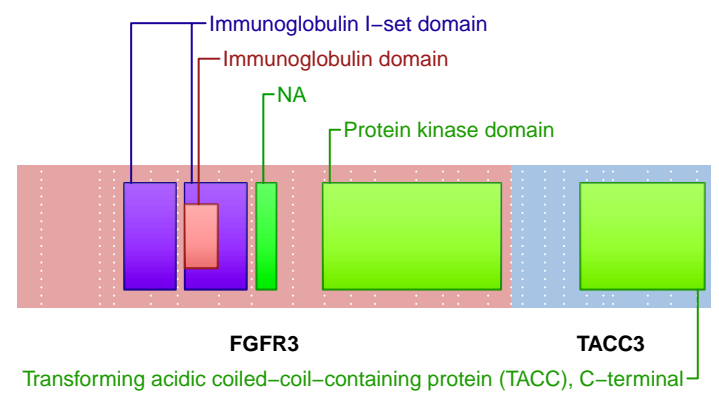

SUPPORTING READ COUNT

Split reads = 18
Discordant mates = 23

- translocation
- duplication
- deletion
- inversion

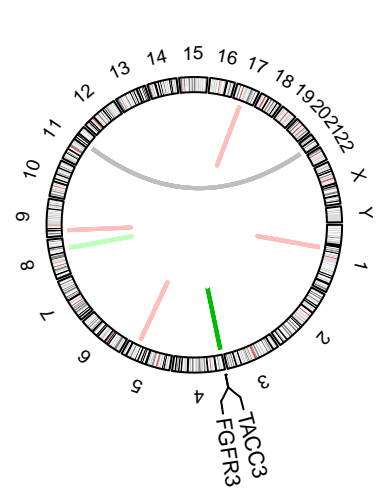
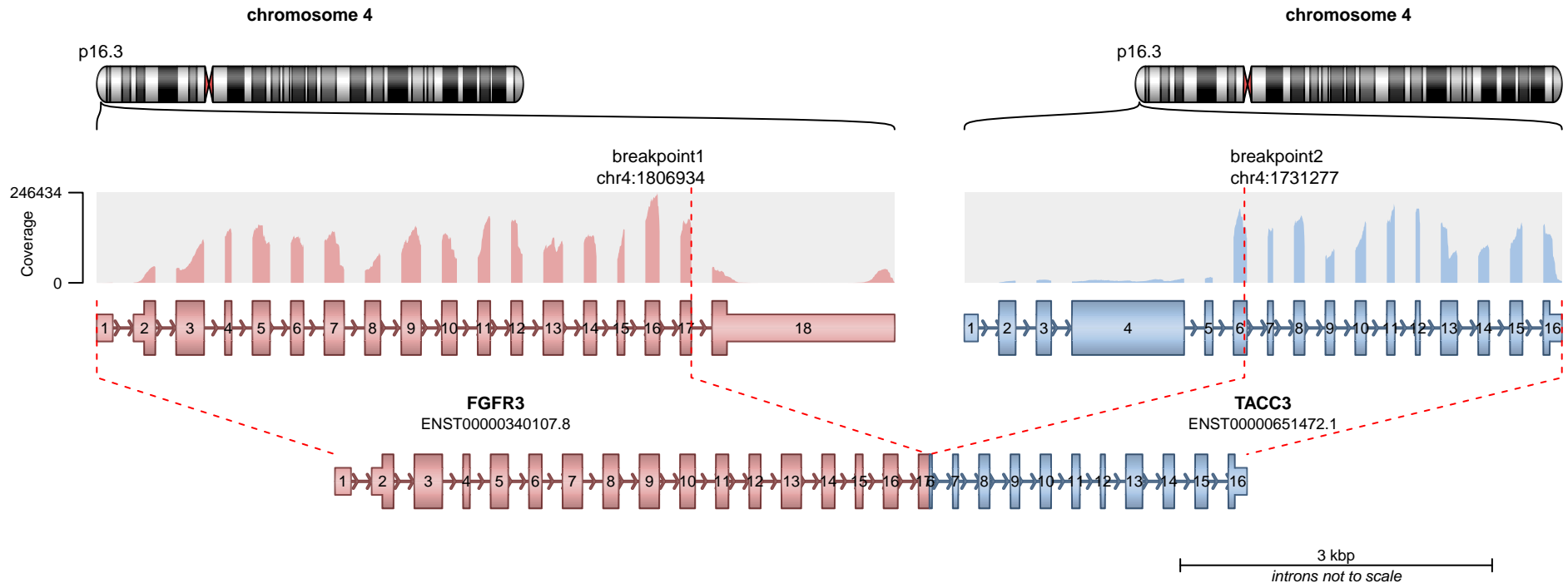

RETAINED PROTEIN DOMAINS
reading frame unclear

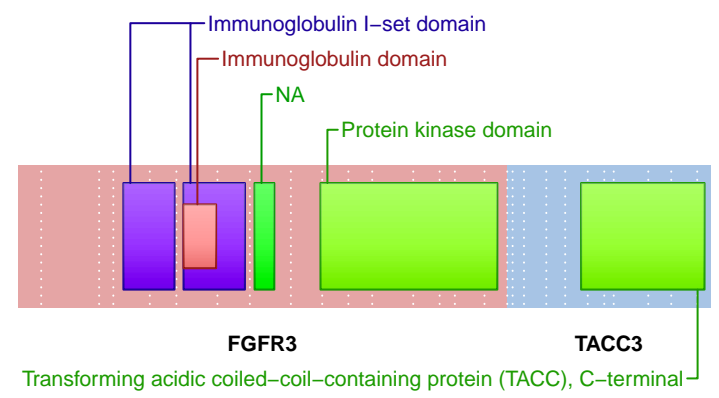

SUPPORTING READ COUNT

Split reads = 3
Discordant mates = 30

- translocation
- duplication
- deletion
- inversion

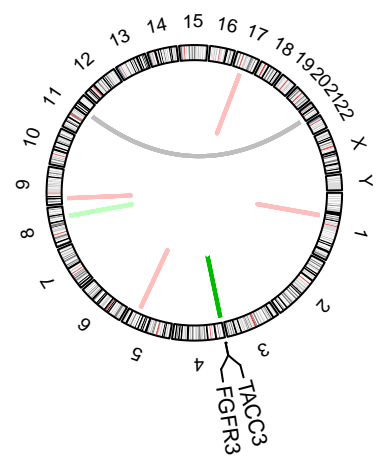
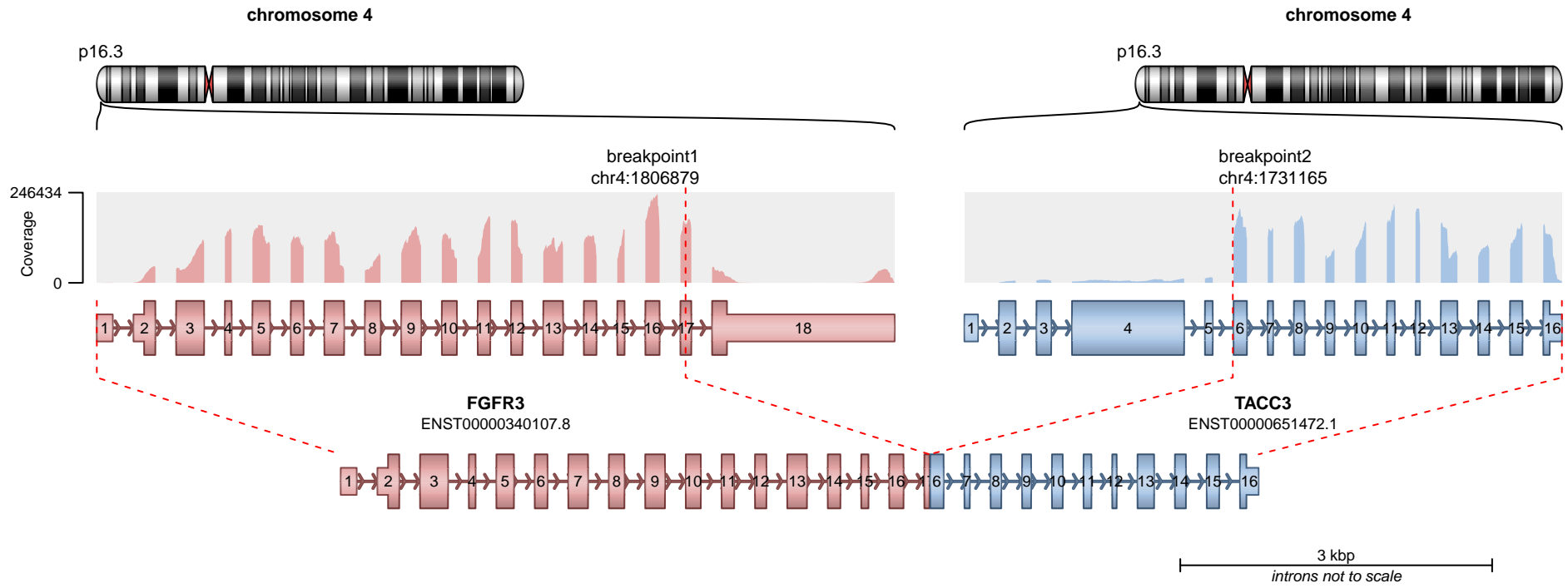

RETAINED PROTEIN DOMAINS
reading frame unclear

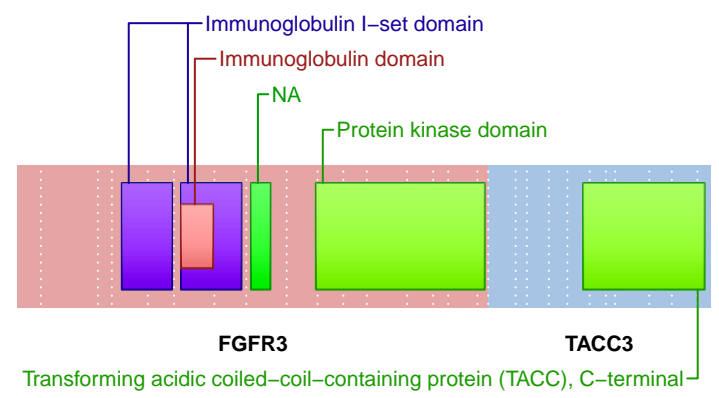

SUPPORTING READ COUNT

Split reads = 3
Discordant mates = 25

- translocation
- duplication
- deletion
- inversion

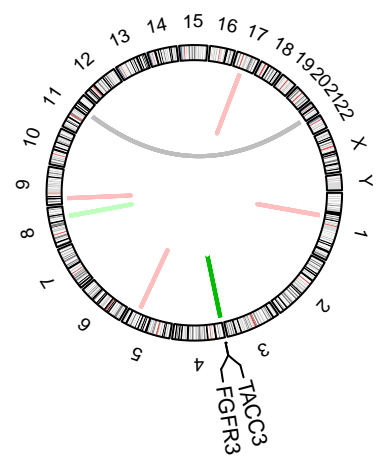
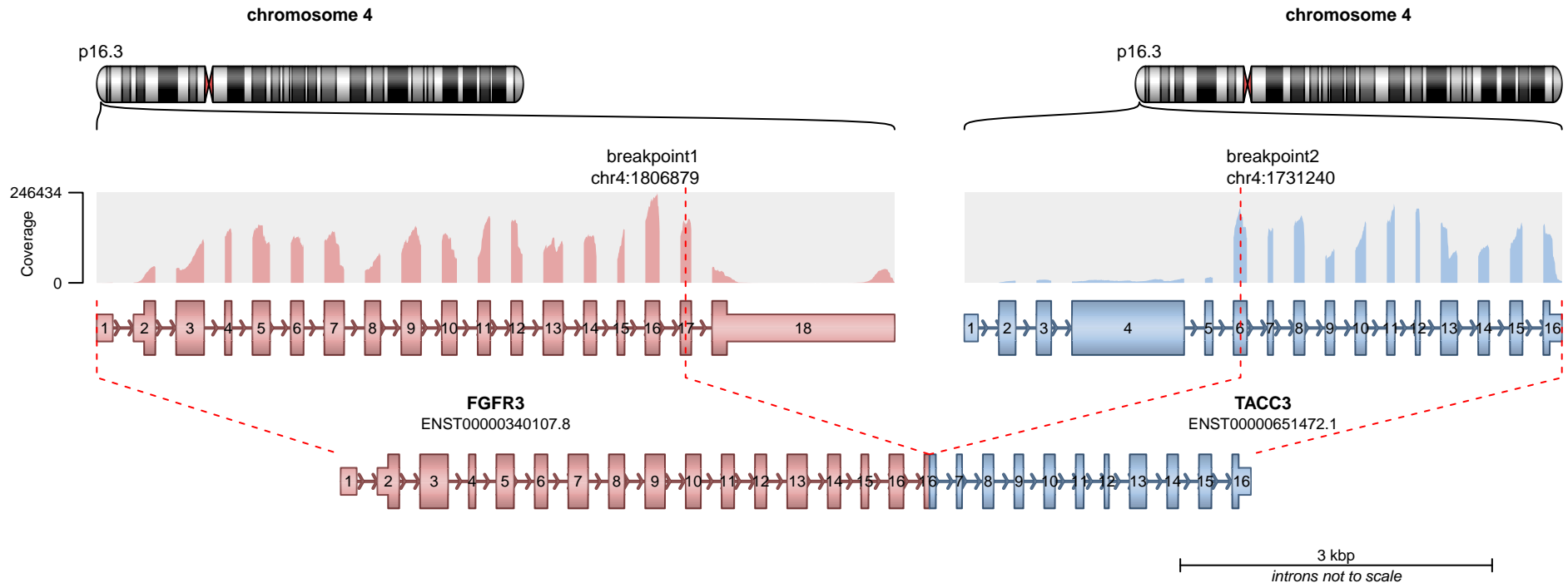

RETAINED PROTEIN DOMAINS
reading frame unclear

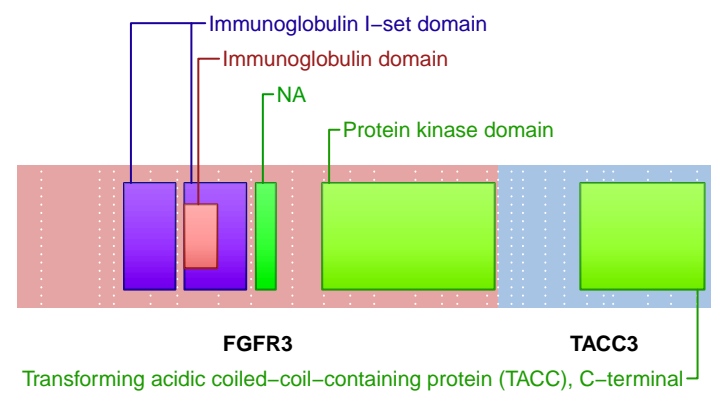

SUPPORTING READ COUNT

Split reads = 6
Discordant mates = 7

- translocation
- duplication
- deletion
- inversion

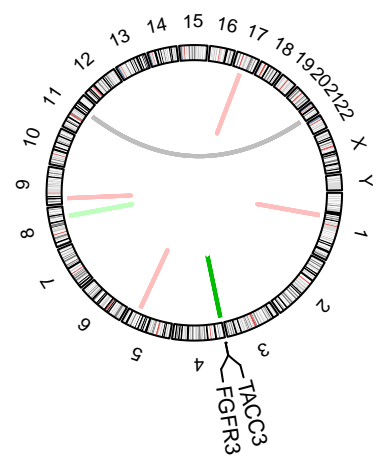
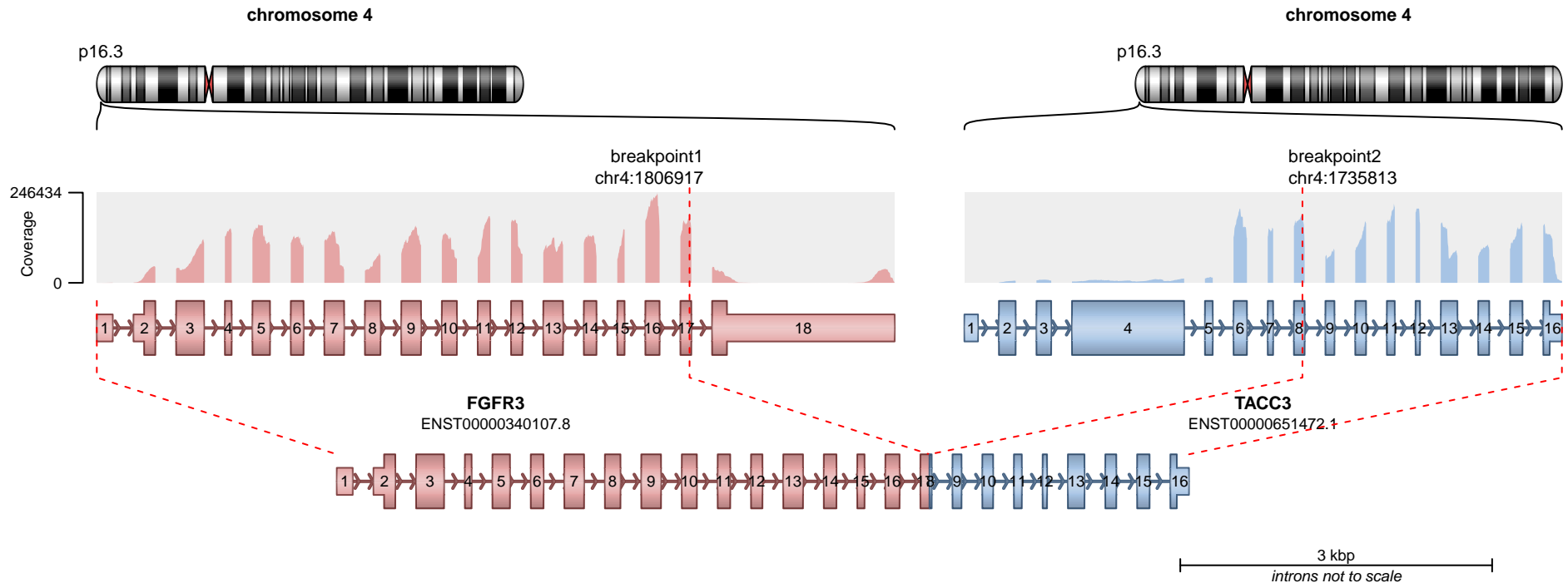

RETAINED PROTEIN DOMAINS
reading frame unclear

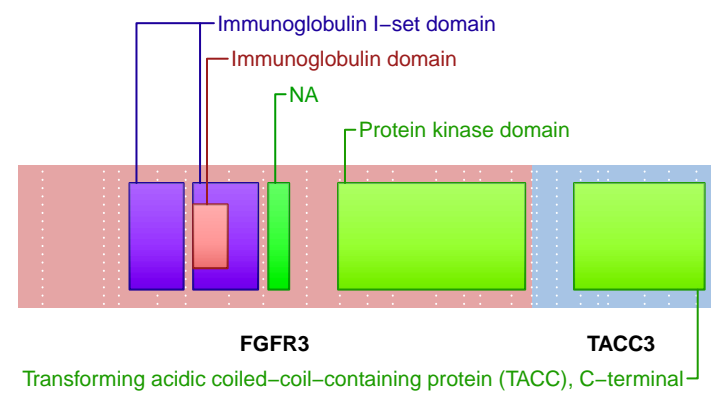

SUPPORTING READ COUNT

Split reads = 7
Discordant mates = 0

- translocation
- duplication
- deletion
- inversion

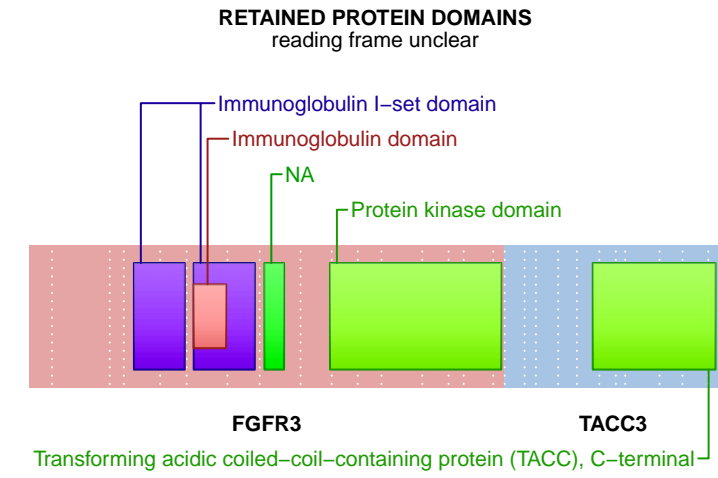
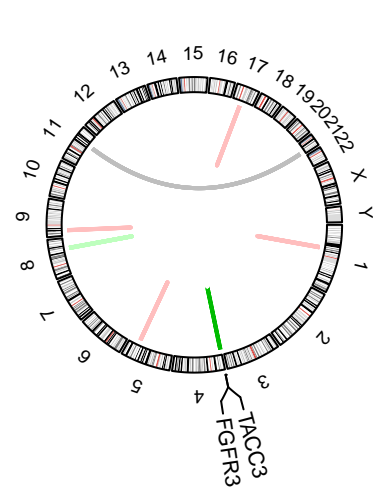
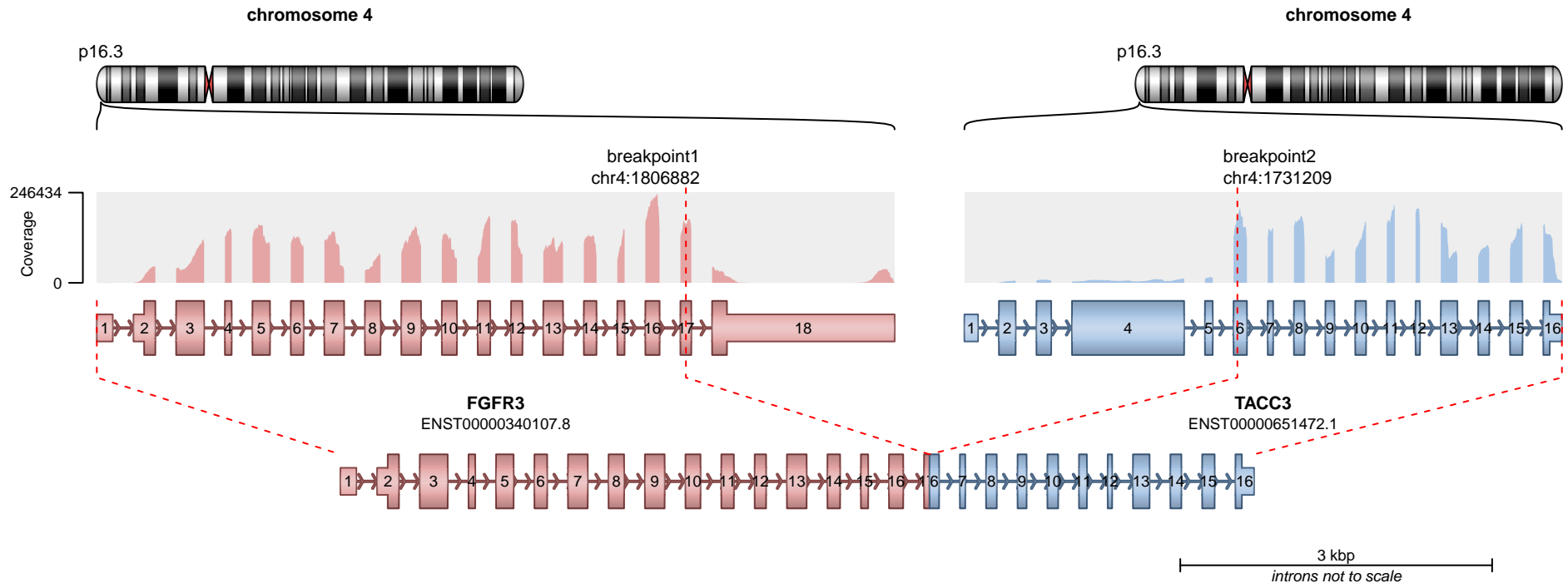

SUPPORTING READ COUNT

Split reads = 3
Discordant mates = 11

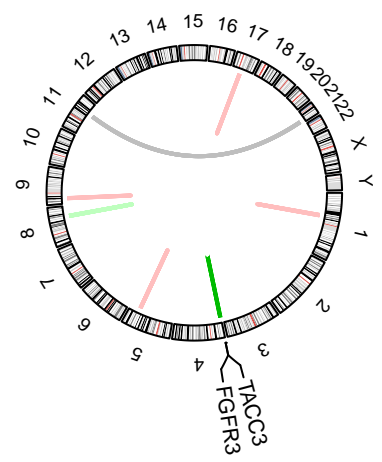
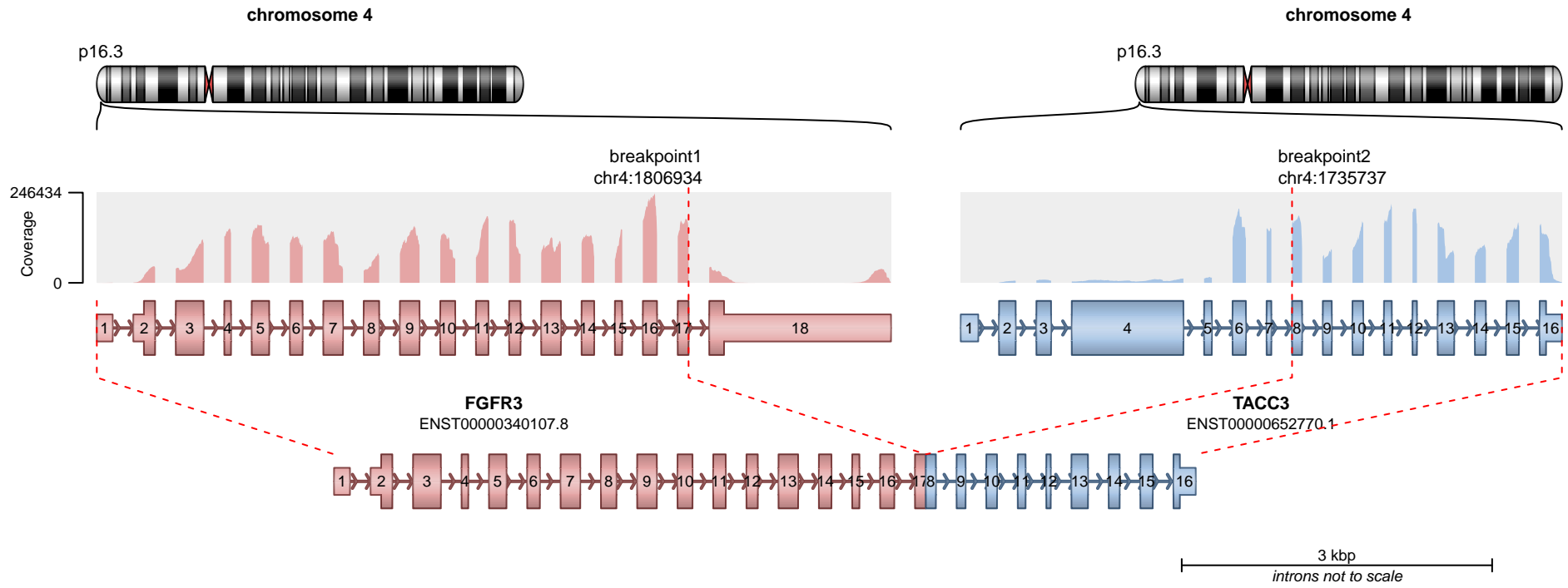

RETAINED PROTEIN DOMAINS
reading frame unclear

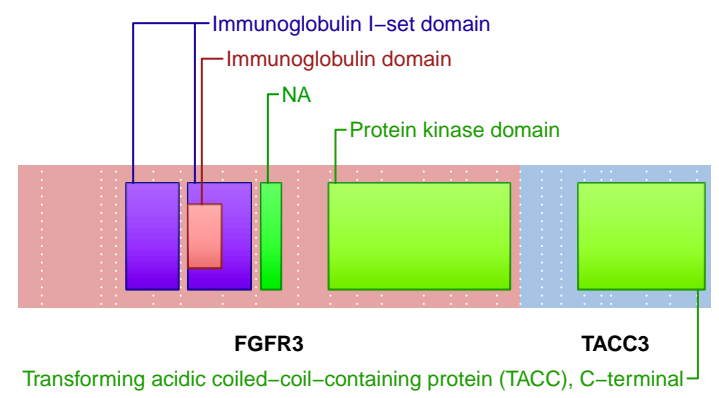

SUPPORTING READ COUNT

Split reads = 5
Discordant mates = 2

- translocation
- duplication
- deletion
- inversion

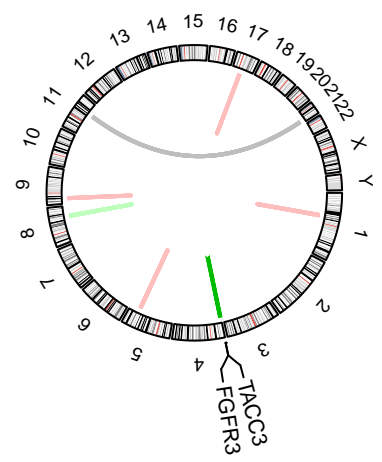
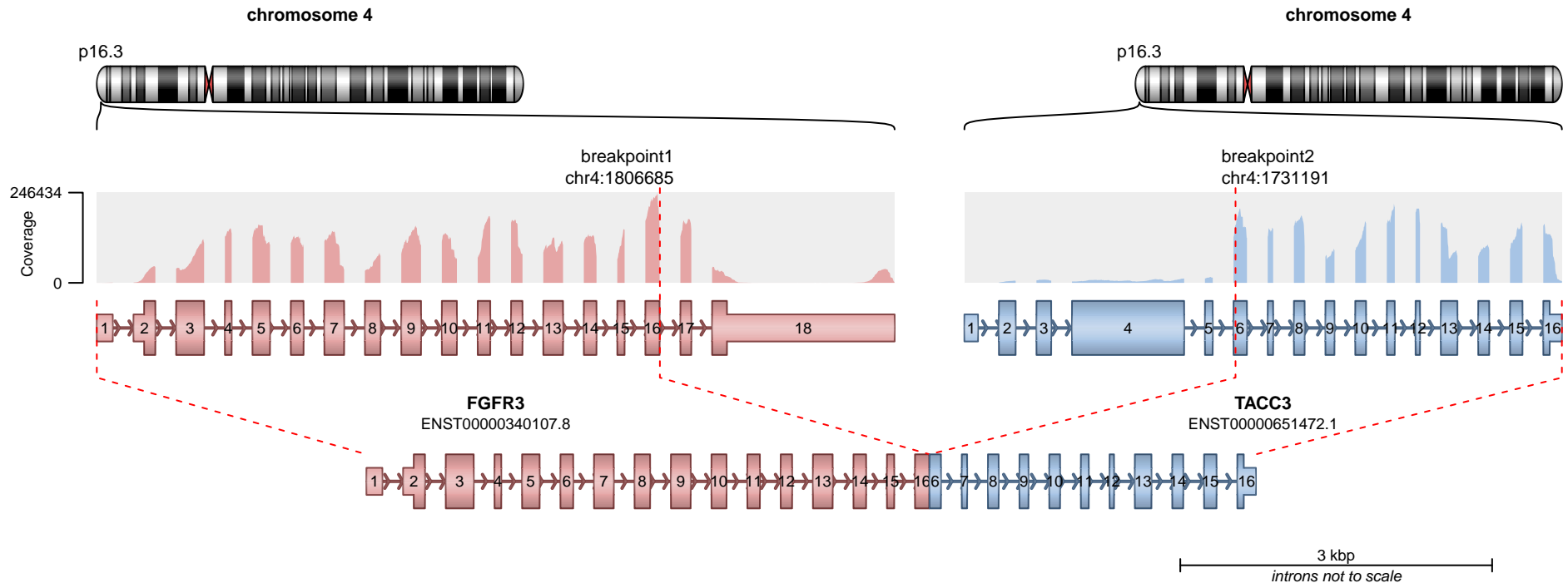

RETAINED PROTEIN DOMAINS
reading frame unclear

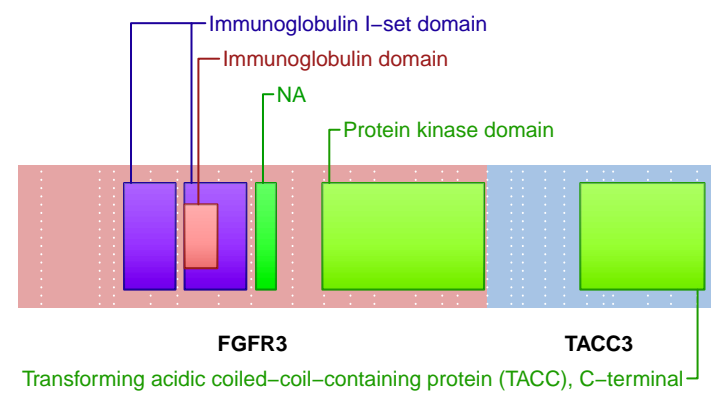

SUPPORTING READ COUNT

Split reads = 3
Discordant mates = 9

- translocation
- duplication
- deletion
- inversion

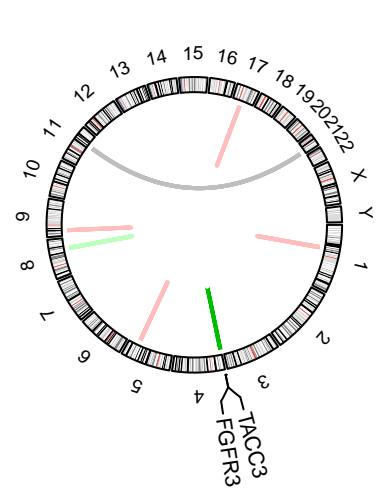
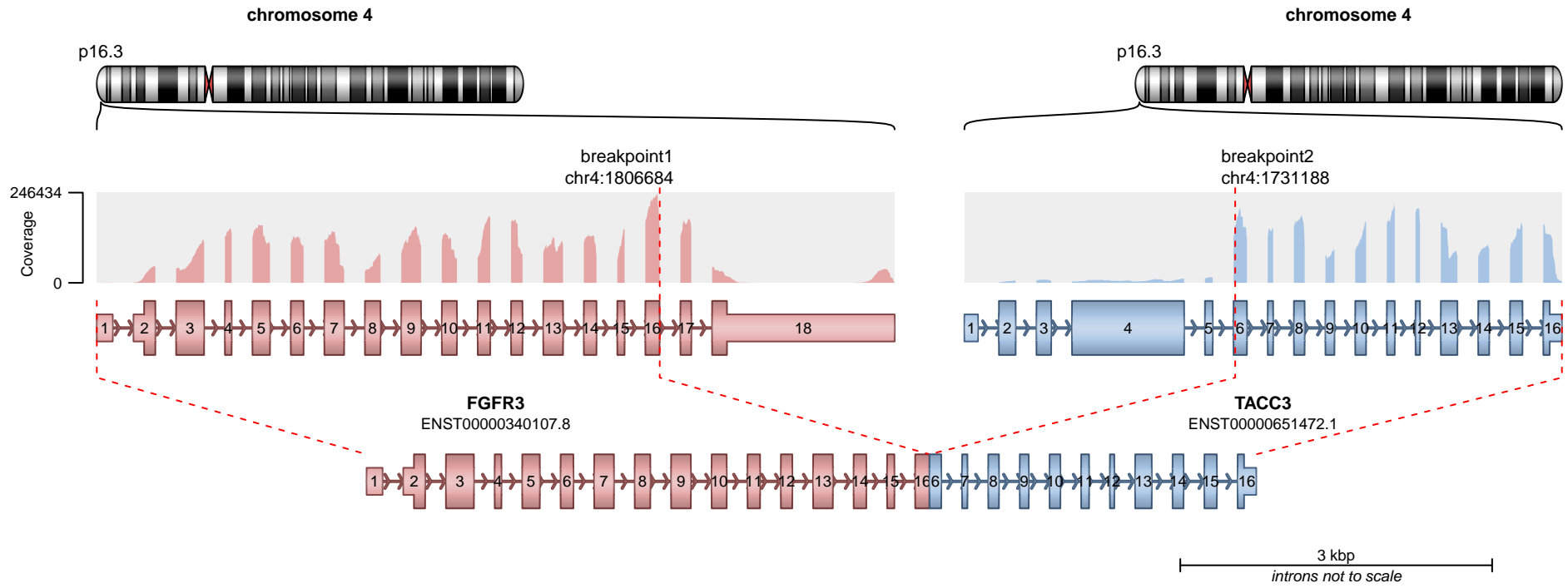

RETAINED PROTEIN DOMAINS
reading frame unclear

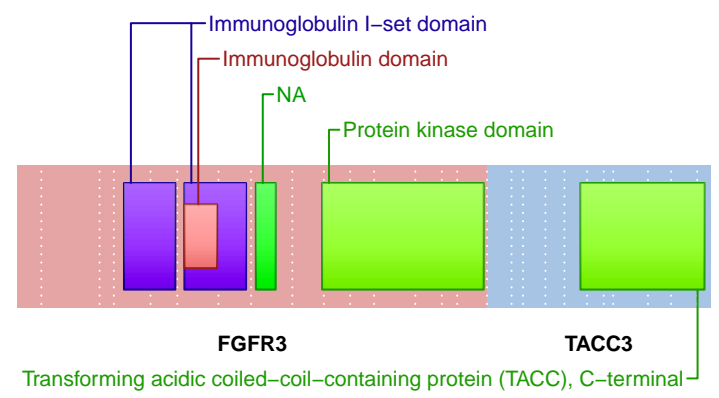

SUPPORTING READ COUNT

Split reads = 3
Discordant mates = 9

- translocation
- duplication
- deletion
- inversion

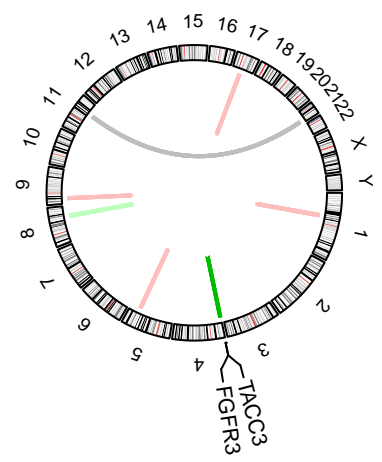
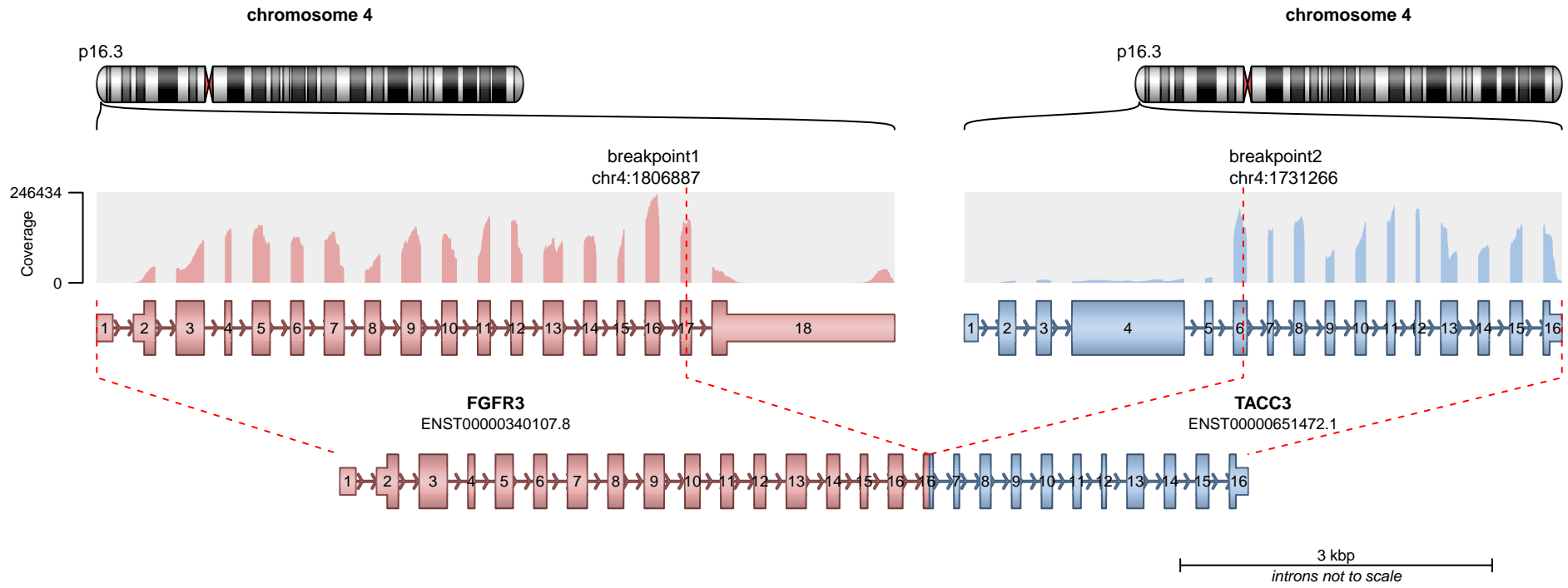

RETAINED PROTEIN DOMAINS
reading frame unclear

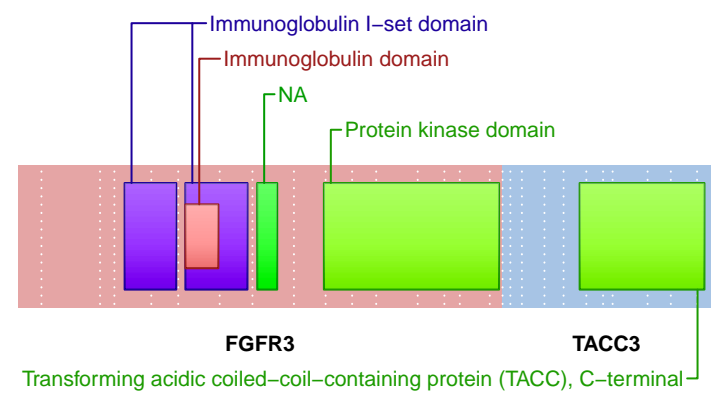

SUPPORTING READ COUNT

Split reads = 3
Discordant mates = 8

— translocation — deletion
— duplication — inversion

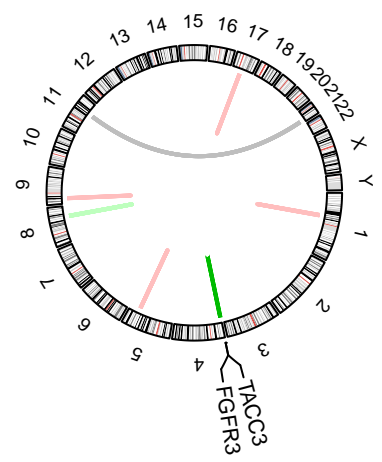
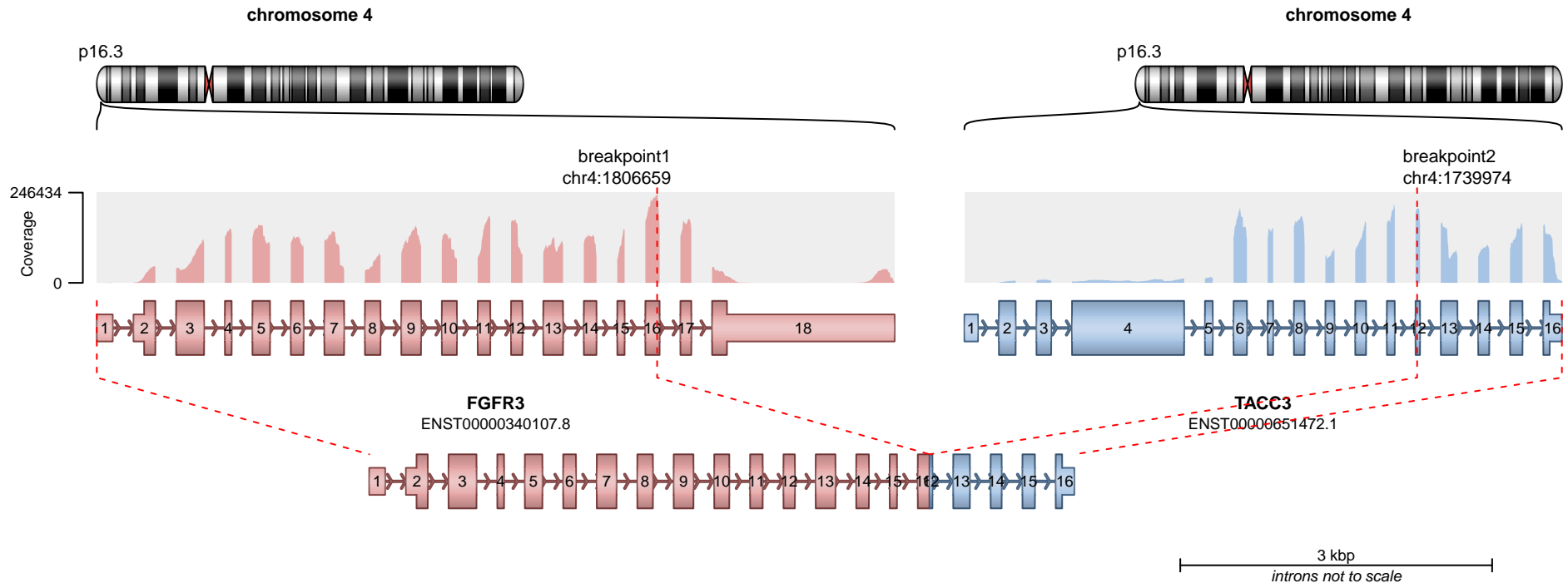

RETAINED PROTEIN DOMAINS
reading frame unclear

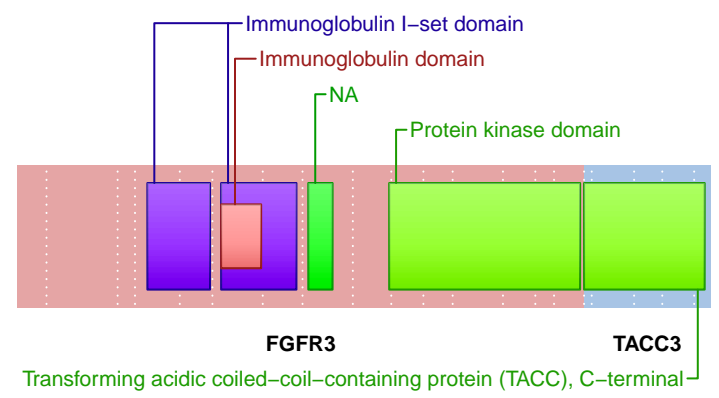

SUPPORTING READ COUNT

Split reads = 5
Discordant mates = 0

- translocation
- duplication
- deletion
- inversion

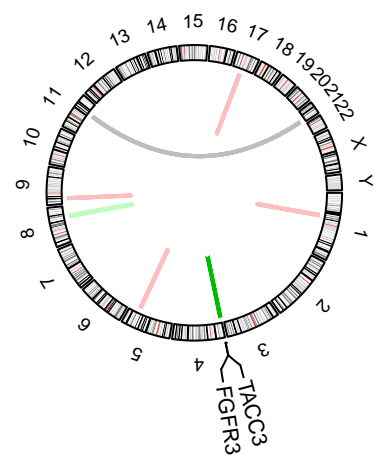
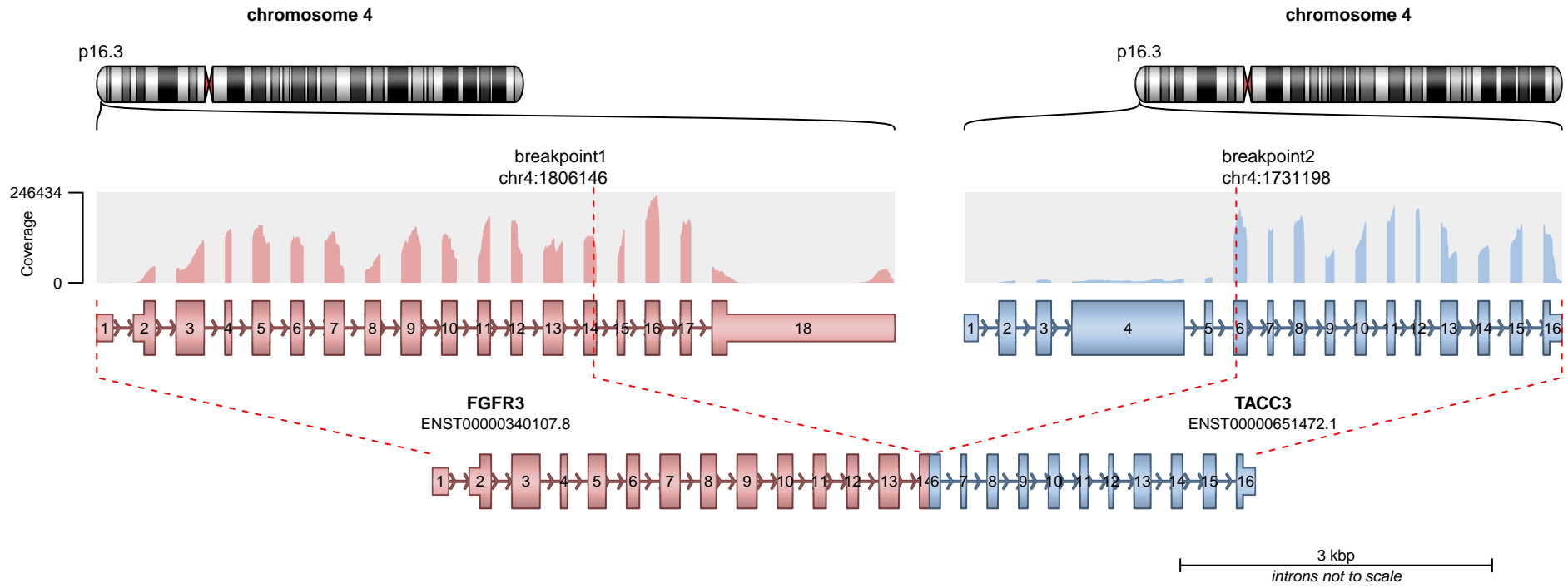

RETAINED PROTEIN DOMAINS
reading frame unclear

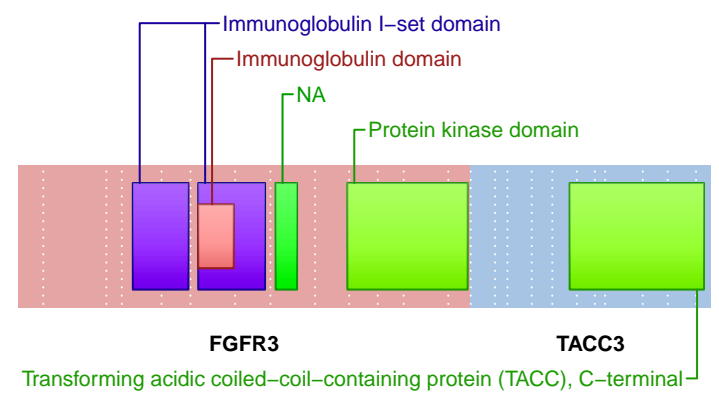

SUPPORTING READ COUNT

Split reads = 5
Discordant mates = 0

- translocation
- duplication
- deletion
- inversion

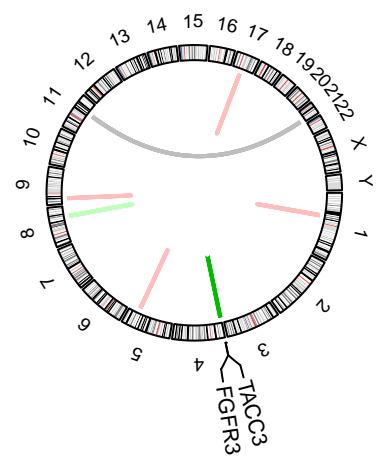
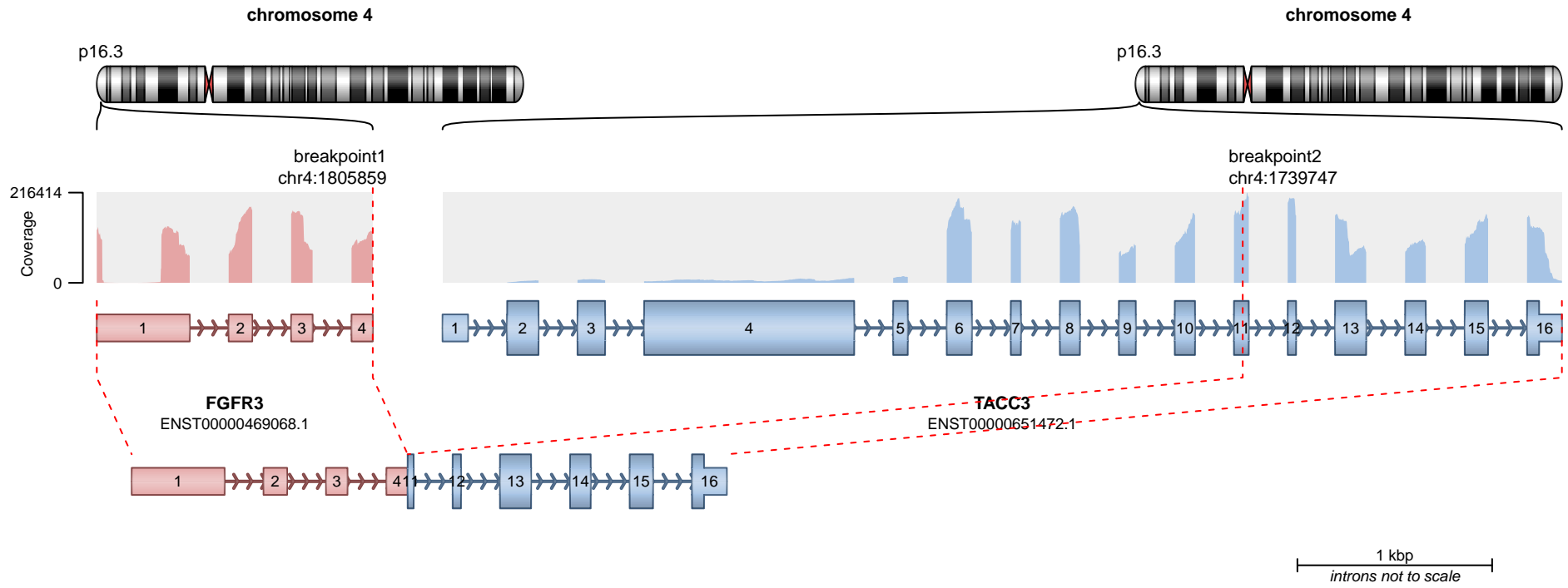

RETAINED PROTEIN DOMAINS
reading frame unclear

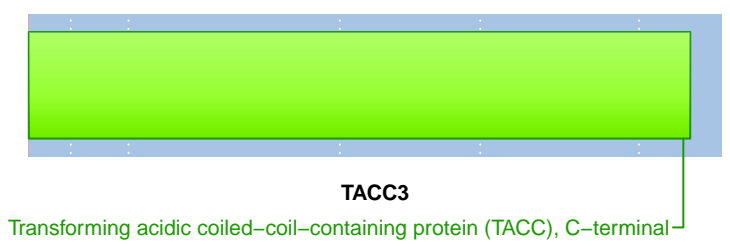

SUPPORTING READ COUNT

Split reads = 5
Discordant mates = 0

- translocation
- duplication
- deletion
- inversion

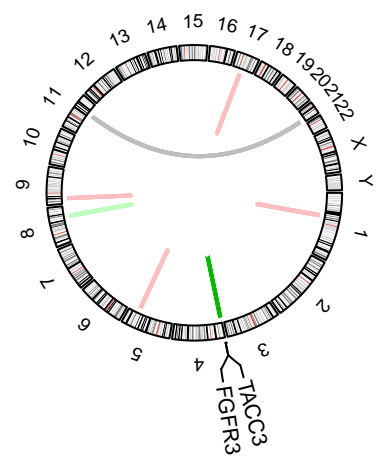
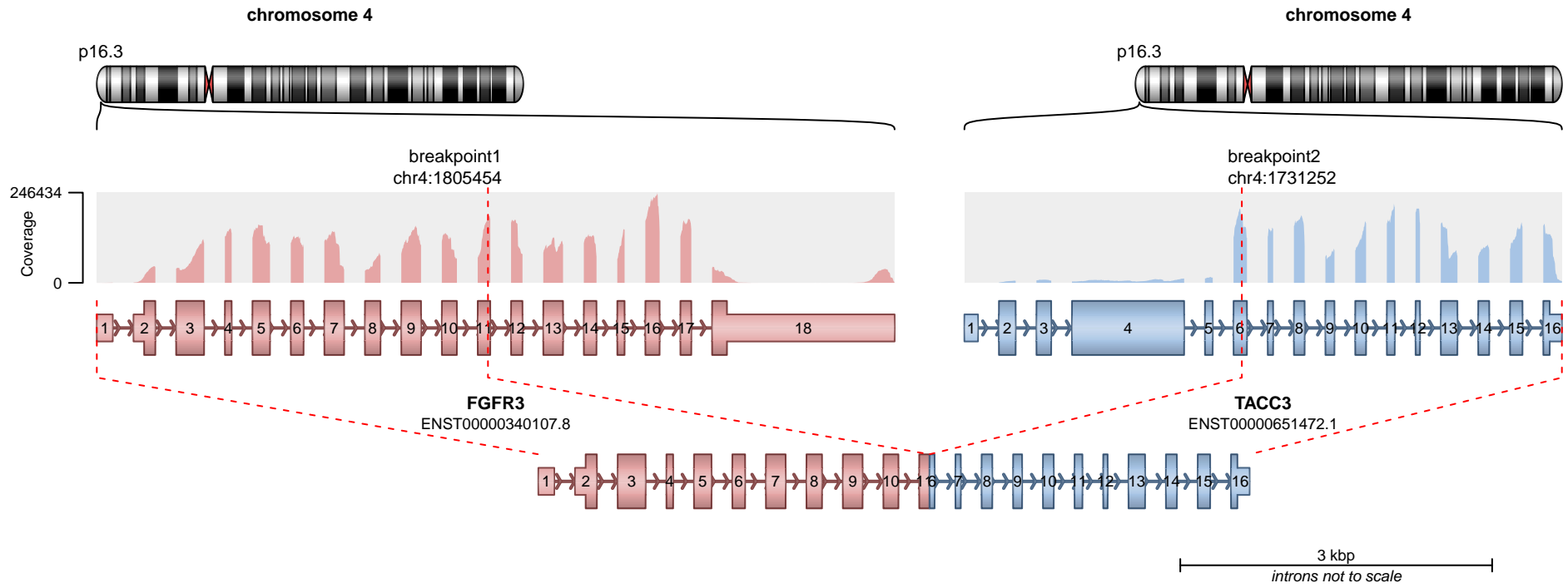

RETAINED PROTEIN DOMAINS
reading frame unclear

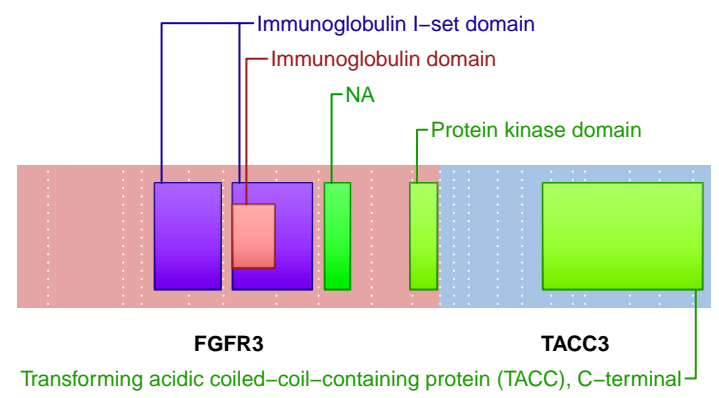

SUPPORTING READ COUNT

Split reads = 5
Discordant mates = 0

- translocation
- duplication
- deletion
- inversion

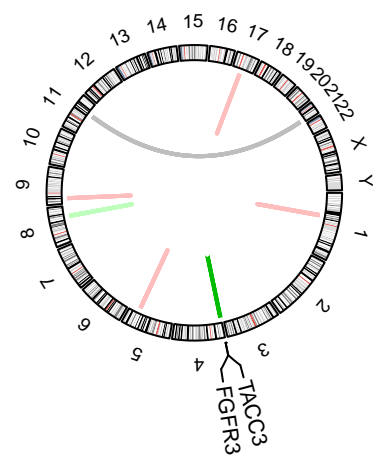
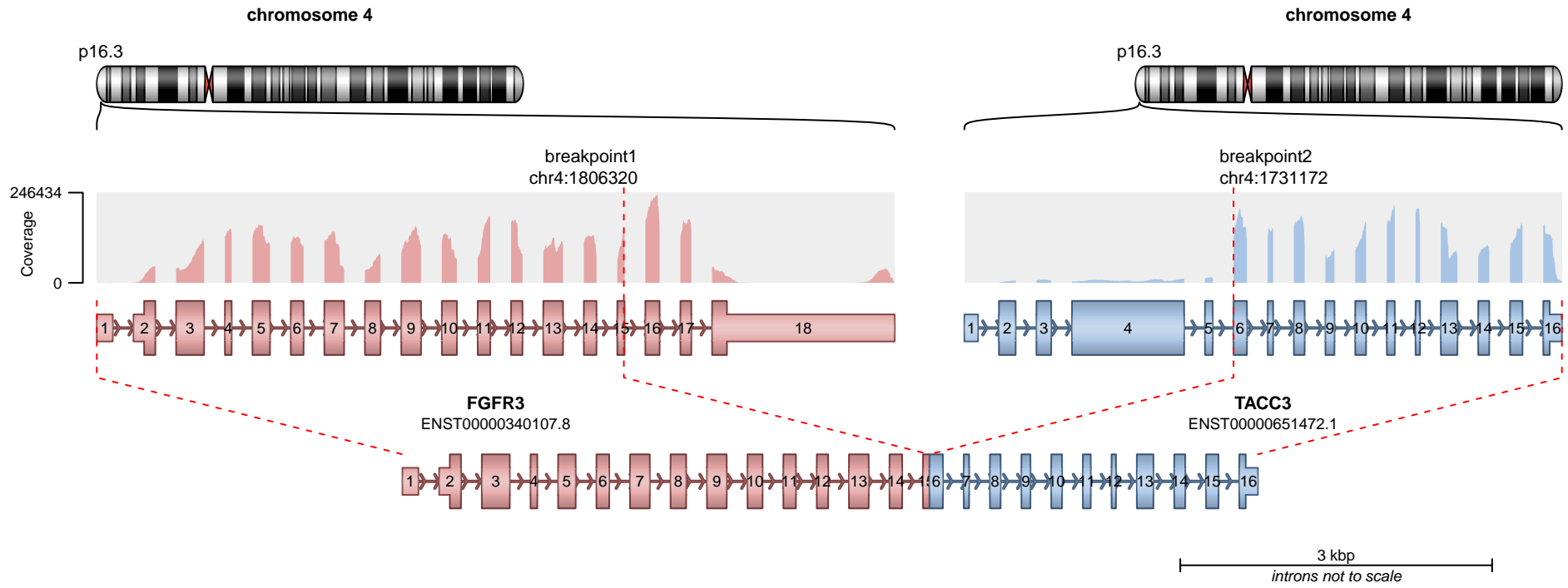

RETAINED PROTEIN DOMAINS
reading frame unclear

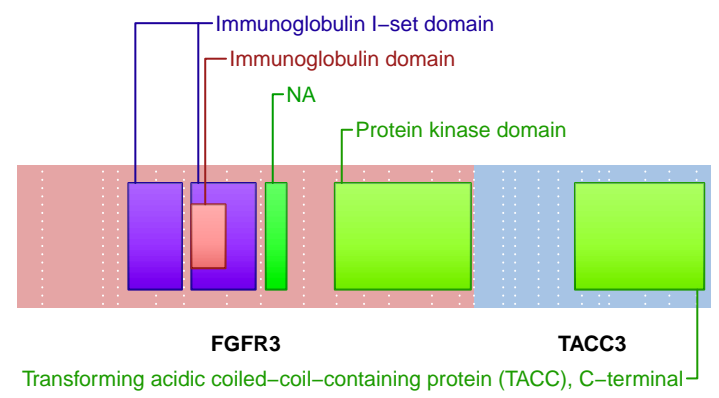

SUPPORTING READ COUNT

Split reads = 4
Discordant mates = 1

- translocation
- duplication
- deletion
- inversion

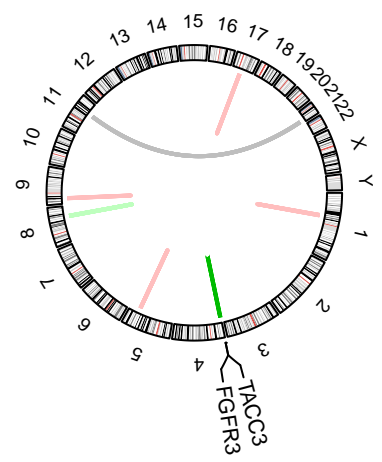
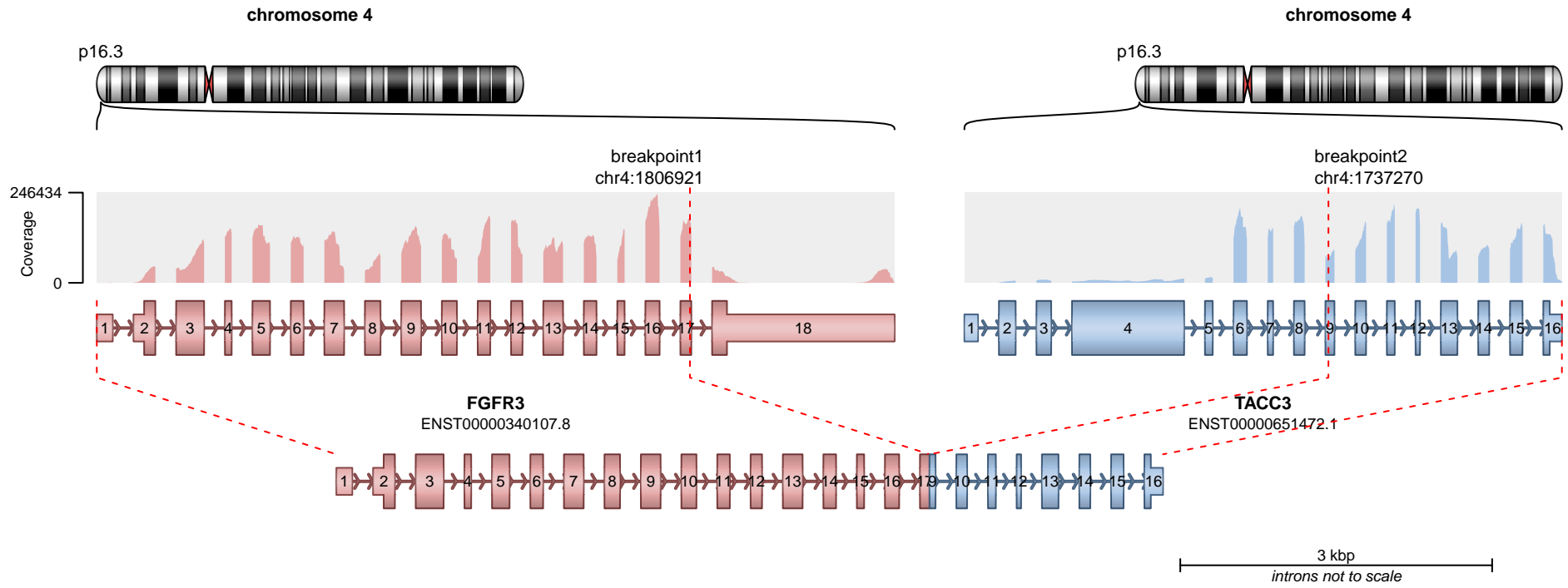

RETAINED PROTEIN DOMAINS
reading frame unclear

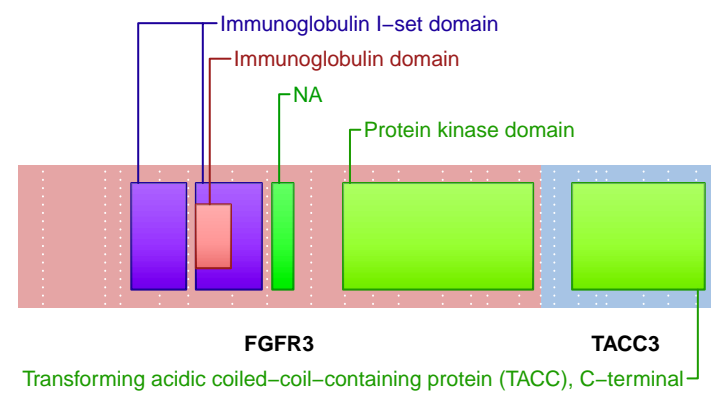

SUPPORTING READ COUNT

Split reads = 4
Discordant mates = 0

- translocation
- duplication
- deletion
- inversion

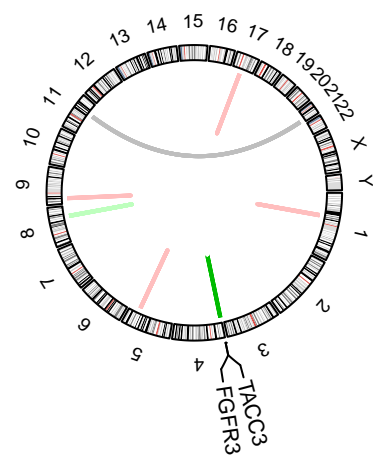
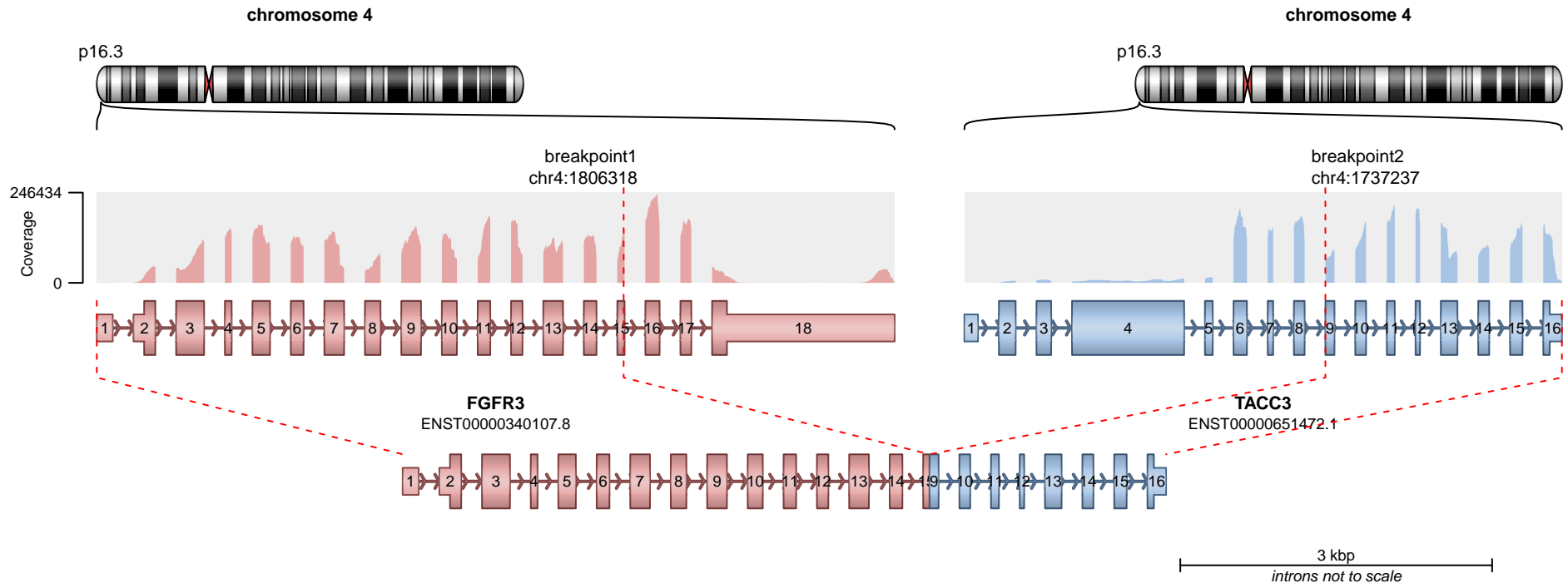

RETAINED PROTEIN DOMAINS
reading frame unclear

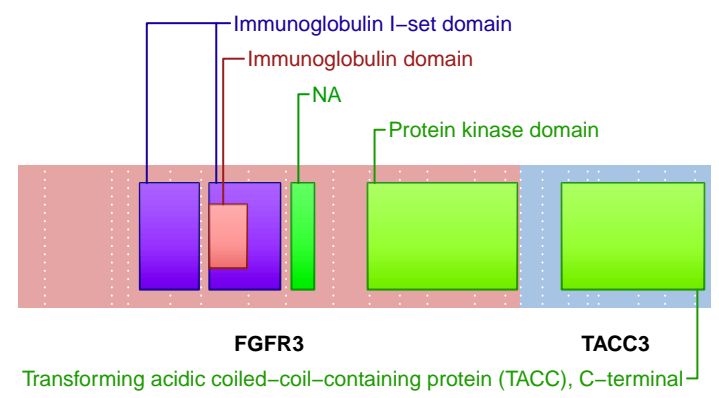

SUPPORTING READ COUNT

Split reads = 4
Discordant mates = 0

- translocation
- duplication
- deletion
- inversion

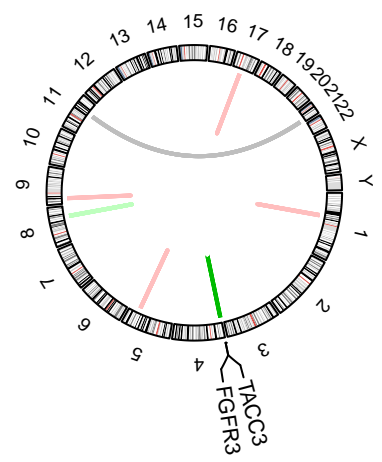
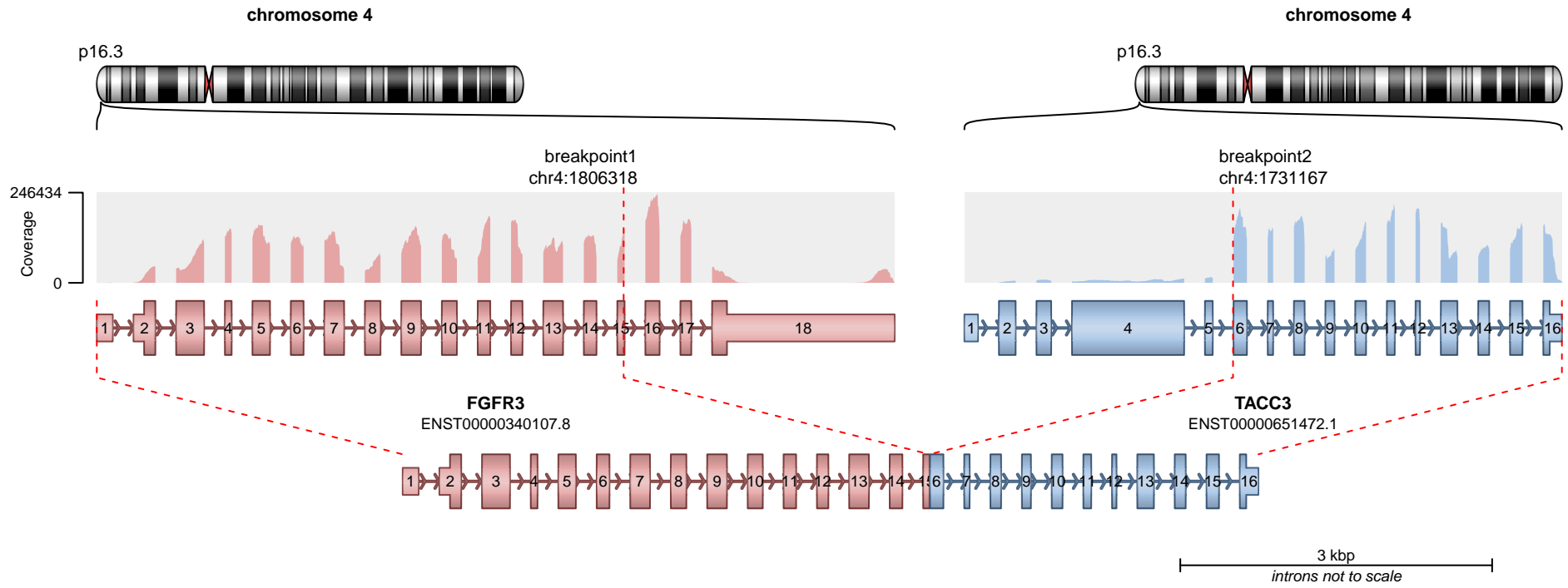

RETAINED PROTEIN DOMAINS
reading frame unclear

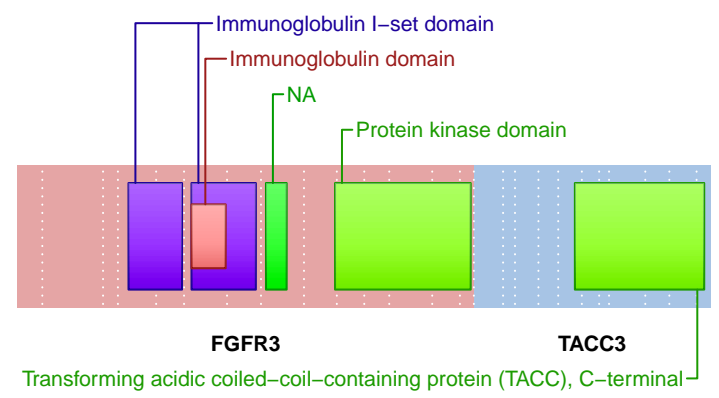

SUPPORTING READ COUNT

Split reads = 3
Discordant mates = 1

- translocation
- duplication
- deletion
- inversion

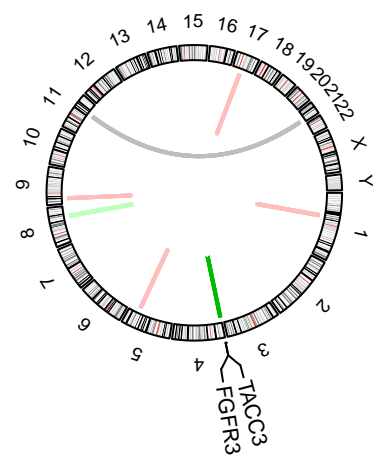
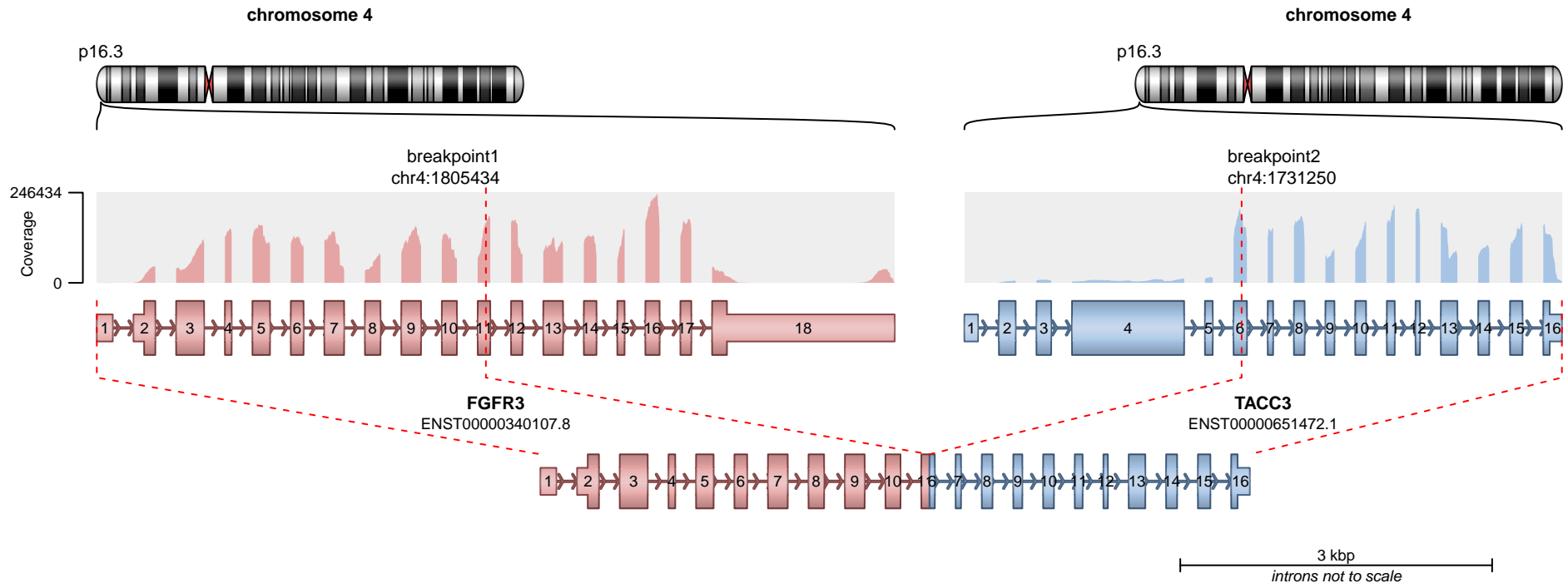

RETAINED PROTEIN DOMAINS
reading frame unclear

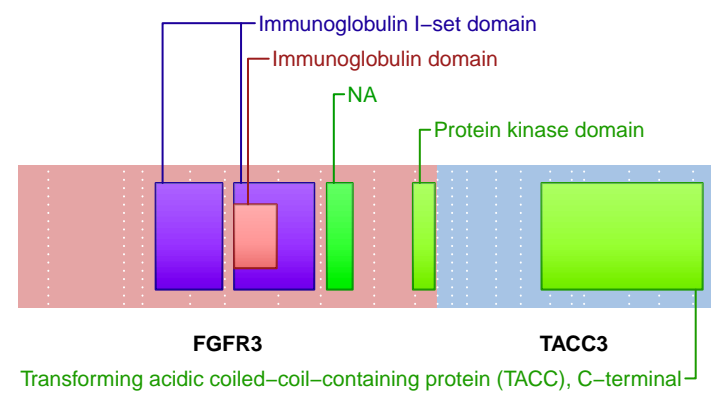

SUPPORTING READ COUNT

Split reads = 3
Discordant mates = 0

- translocation
- duplication
- deletion
- inversion

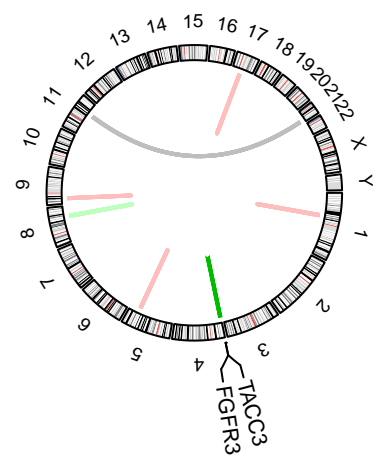
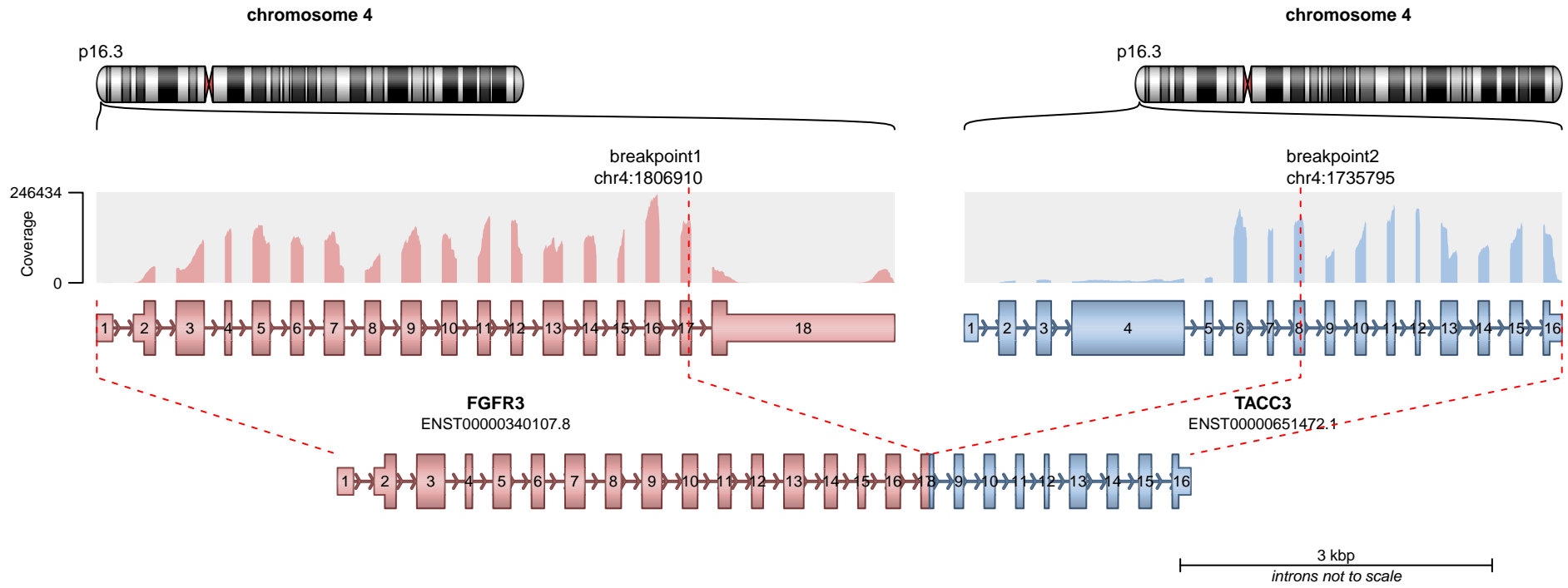

RETAINED PROTEIN DOMAINS
reading frame unclear

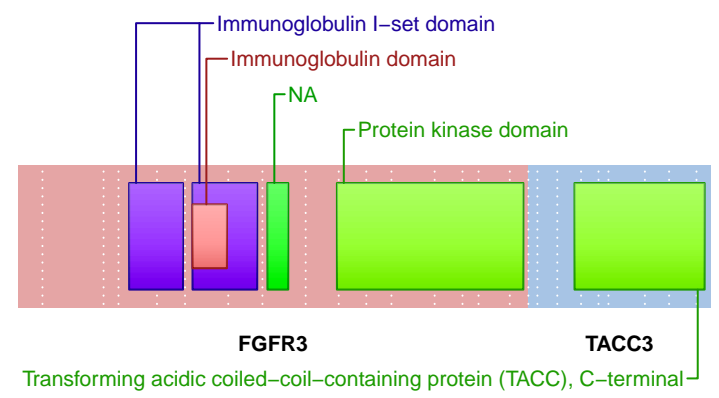

SUPPORTING READ COUNT

Split reads = 3
Discordant mates = 0

- translocation
- duplication
- deletion
- inversion

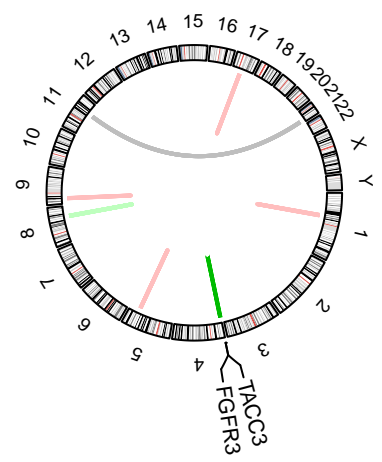
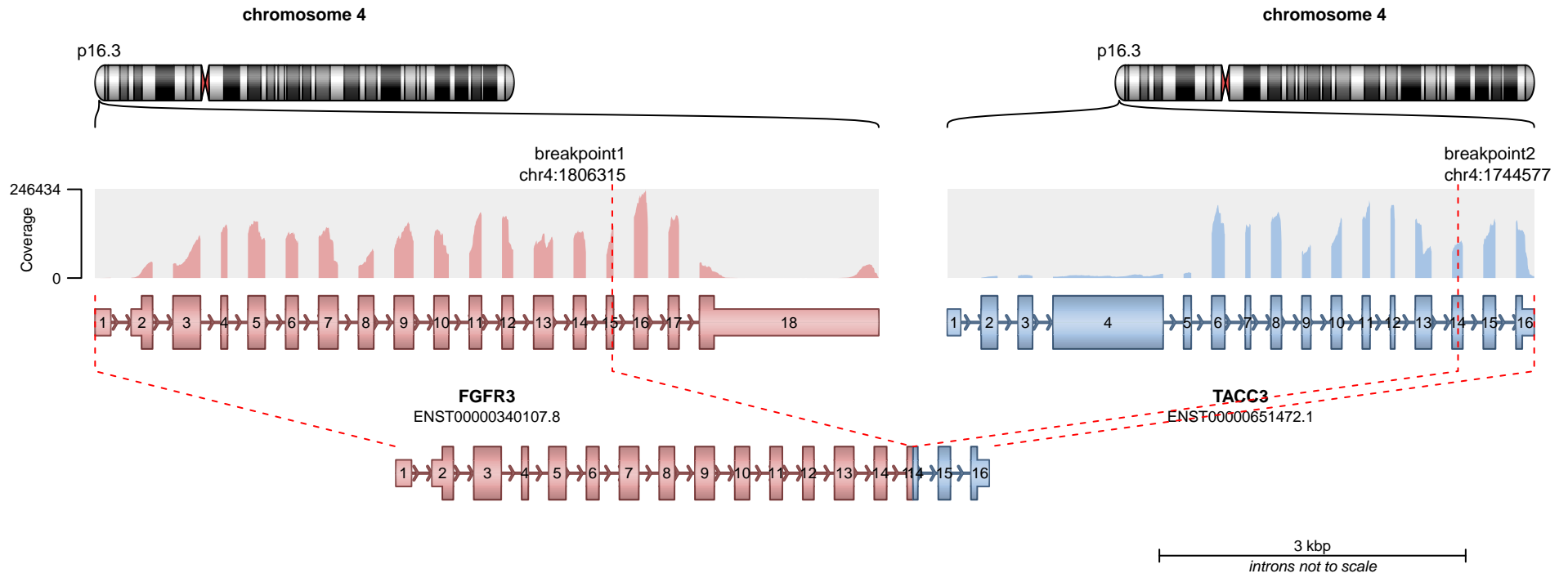

RETAINED PROTEIN DOMAINS
reading frame unclear

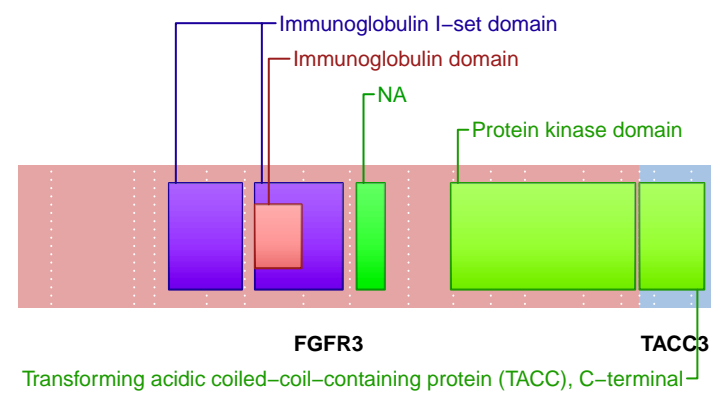

SUPPORTING READ COUNT

Split reads = 3
Discordant mates = 0

- translocation
- duplication
- deletion
- inversion

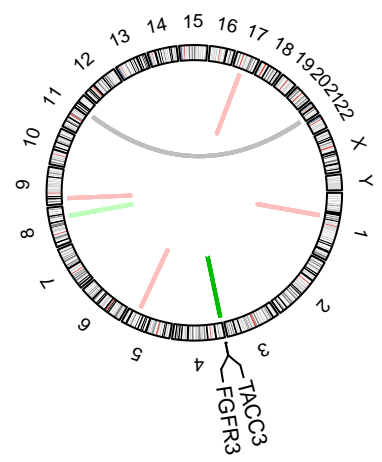
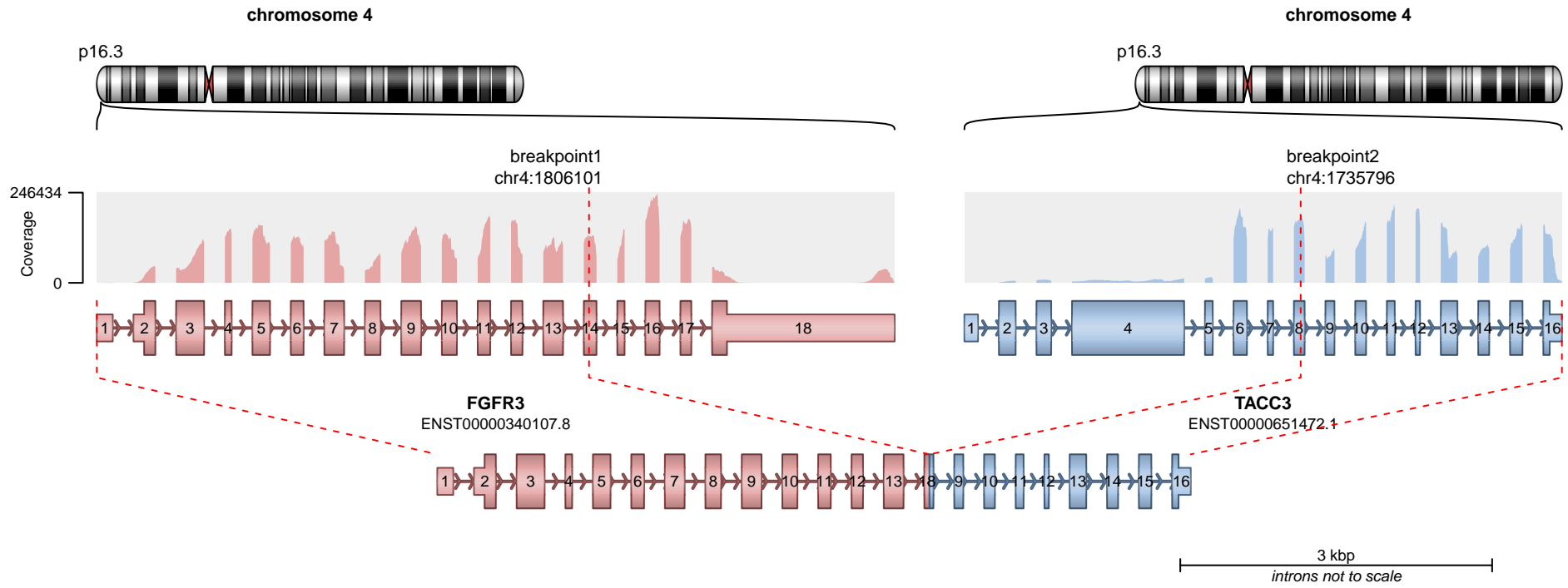

RETAINED PROTEIN DOMAINS
reading frame unclear

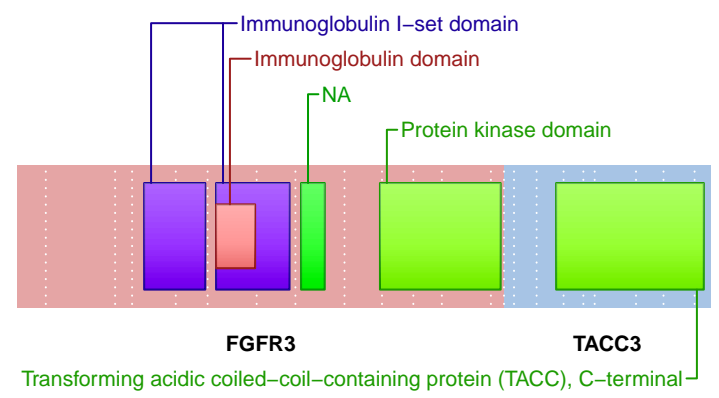

SUPPORTING READ COUNT

Split reads = 3
Discordant mates = 0

- translocation
- duplication
- deletion
- inversion

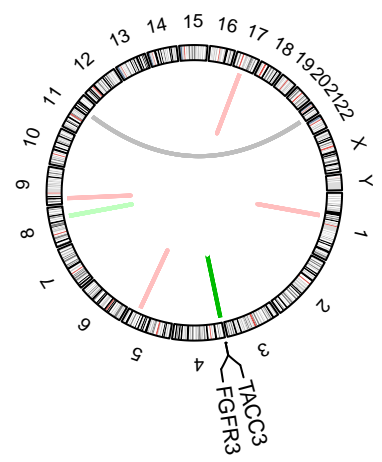
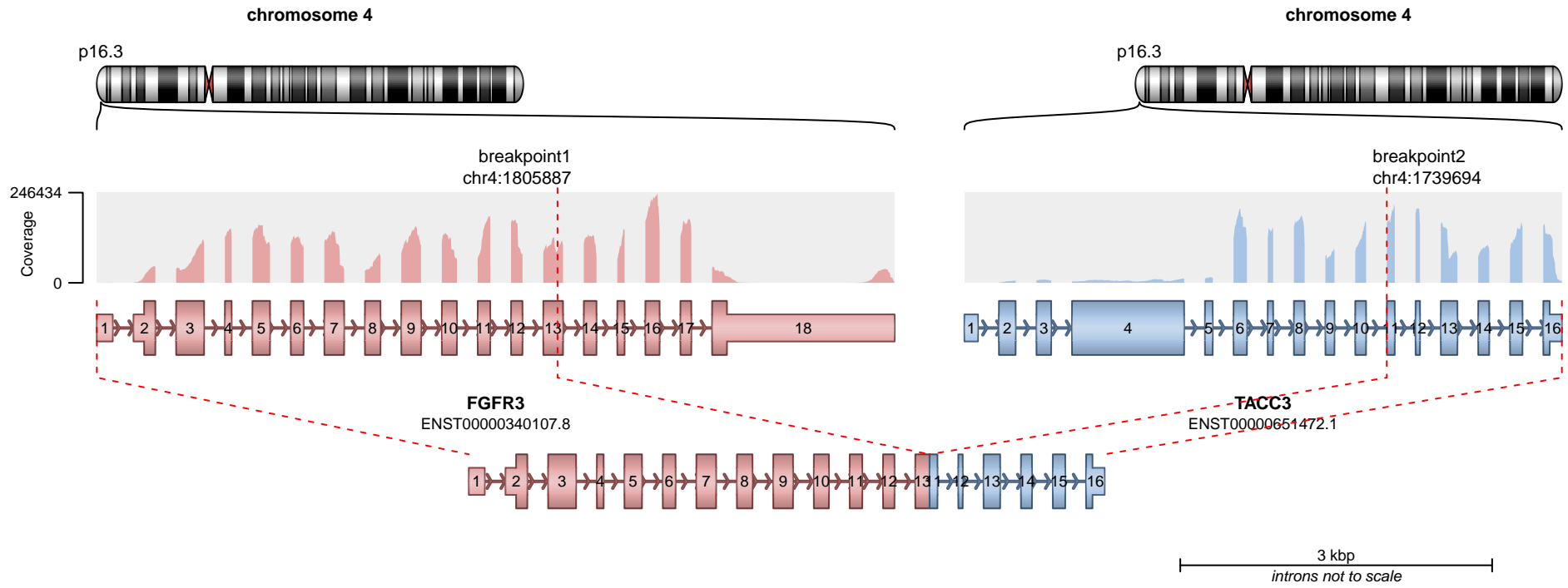

RETAINED PROTEIN DOMAINS
reading frame unclear

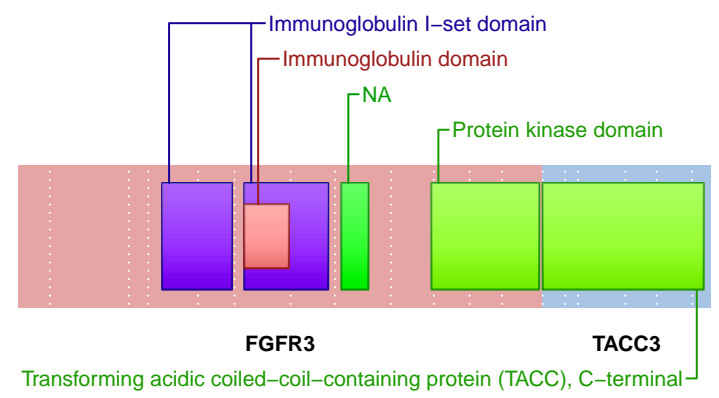

SUPPORTING READ COUNT

Split reads = 3
Discordant mates = 0

— translocation — deletion
— duplication — inversion

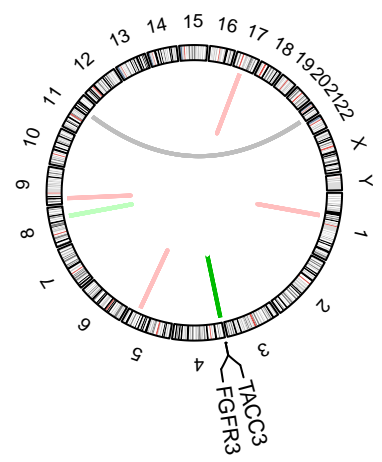
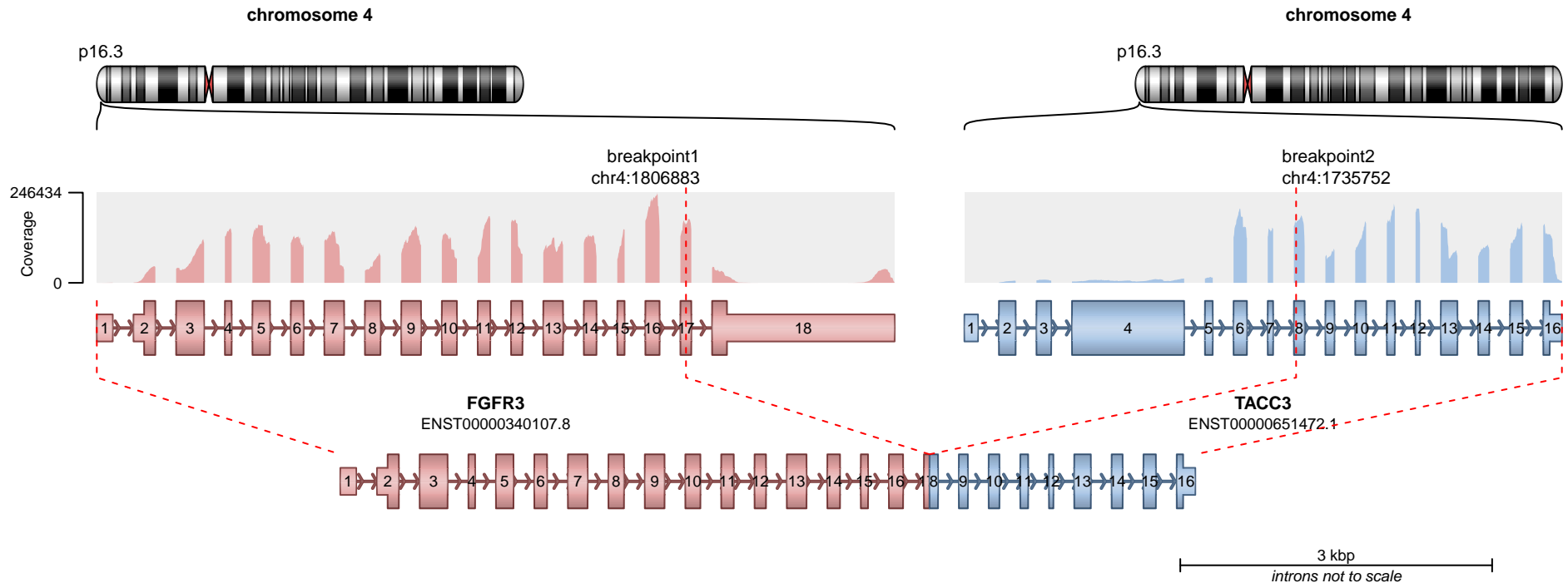

— translocation — deletion
— duplication — inversion

RETAINED PROTEIN DOMAINS
reading frame unclear

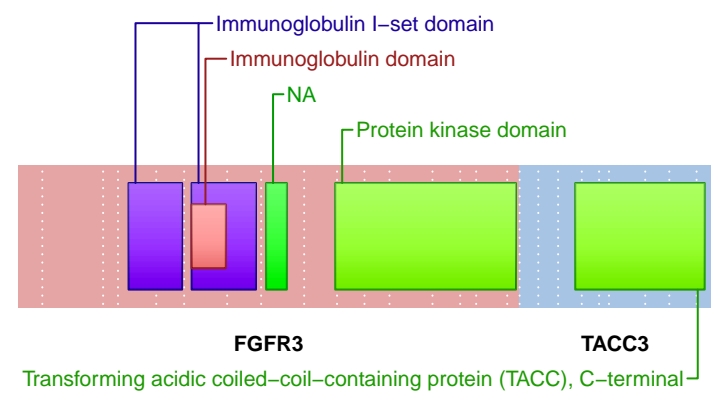

SUPPORTING READ COUNT

Split reads = 3
Discordant mates = 0

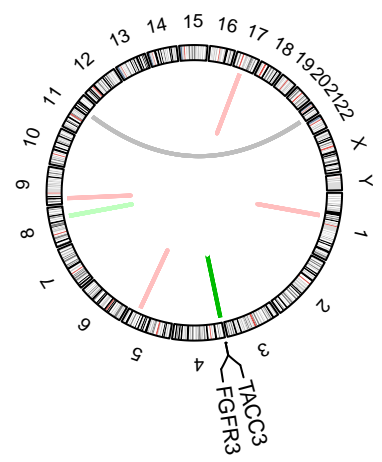
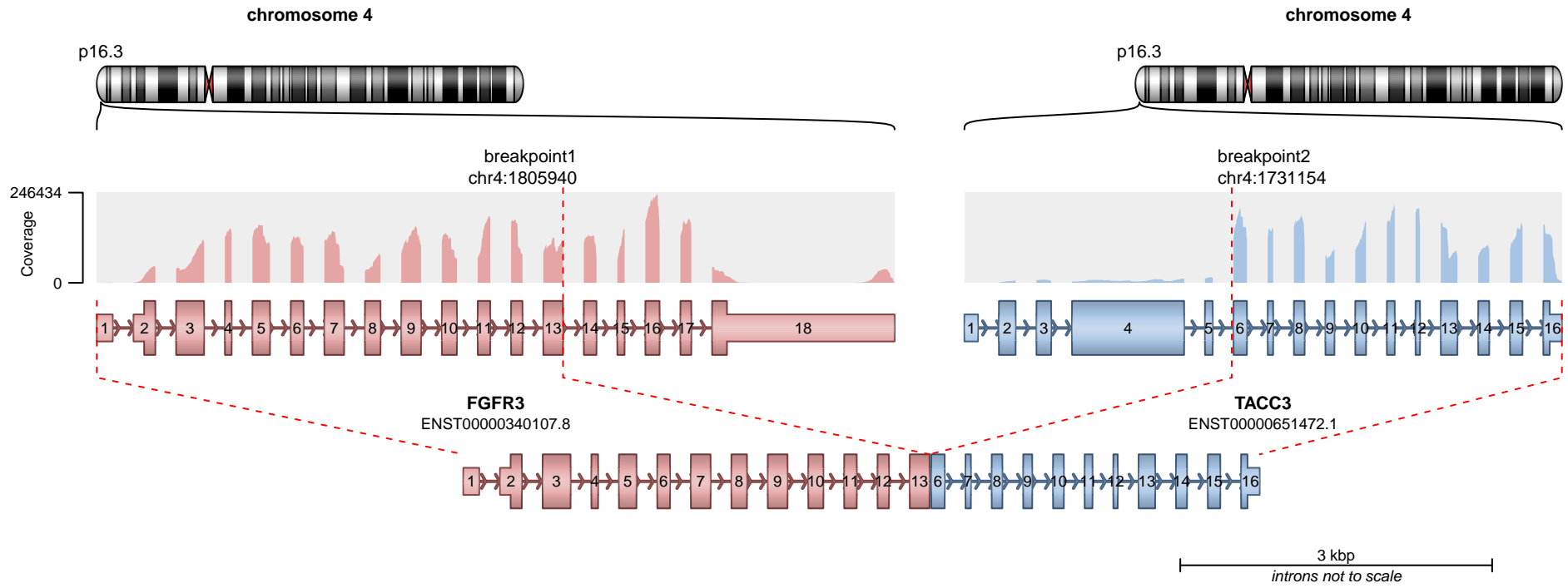

RETAINED PROTEIN DOMAINS
reading frame unclear

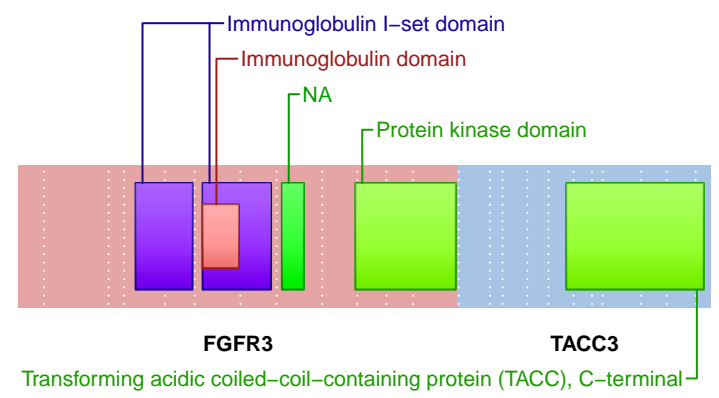

SUPPORTING READ COUNT

Split reads = 3
Discordant mates = 0

- translocation
- duplication
- deletion
- inversion

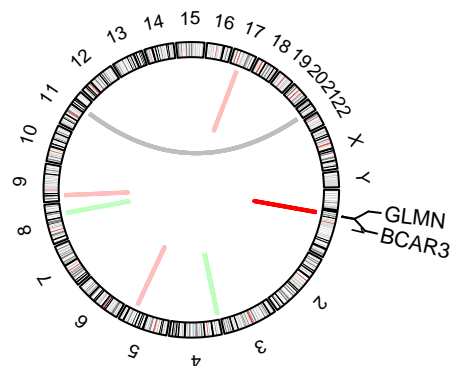
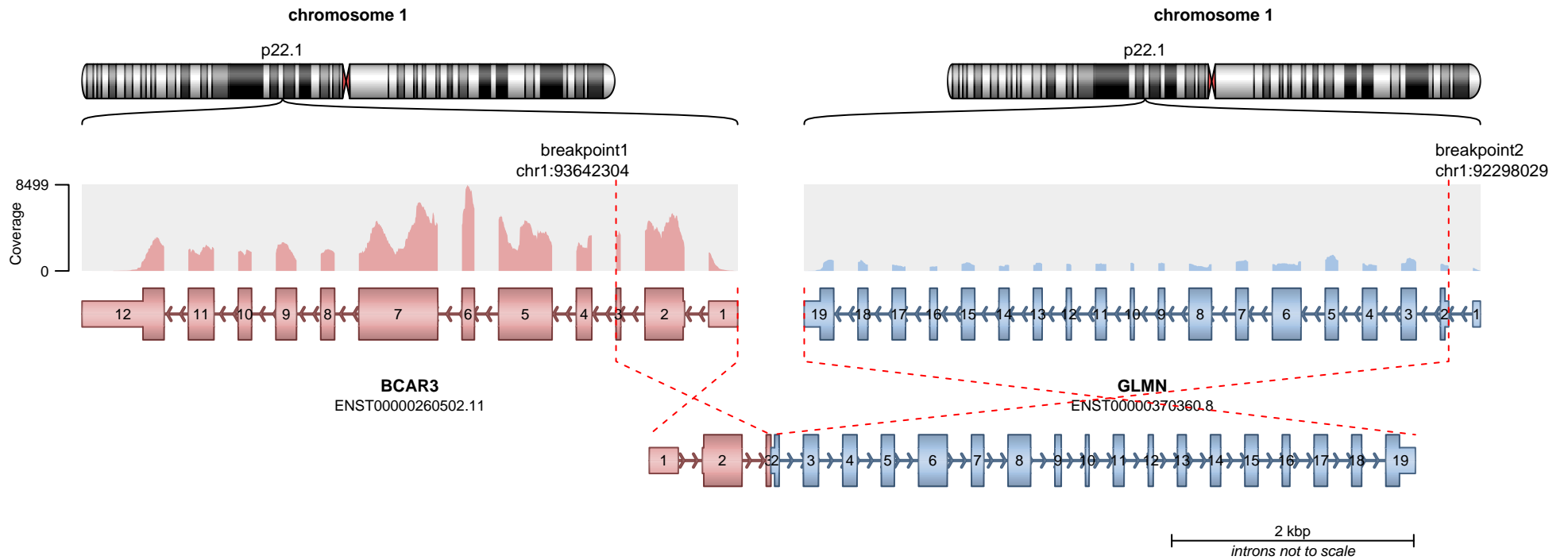

RETAINED PROTEIN DOMAINS
reading frame unclear

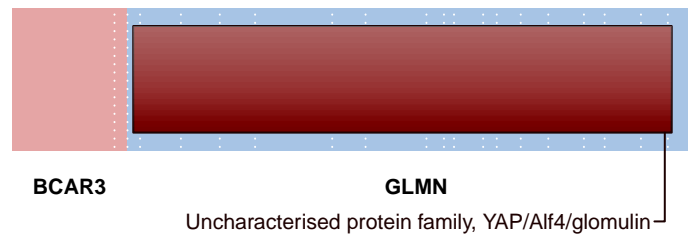

SUPPORTING READ COUNT

Split reads = 123
Discordant mates = 2

- translocation
- duplication
- deletion
- inversion

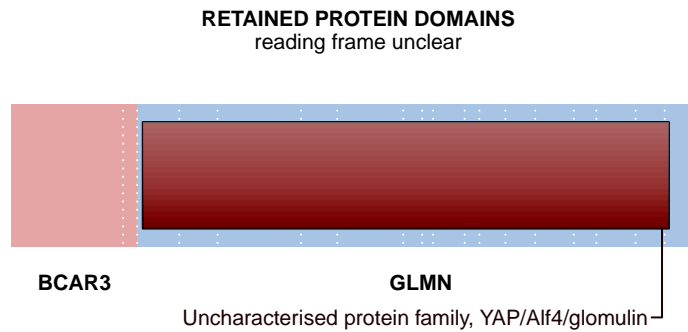
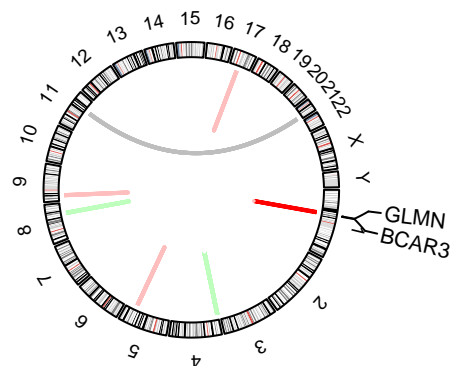
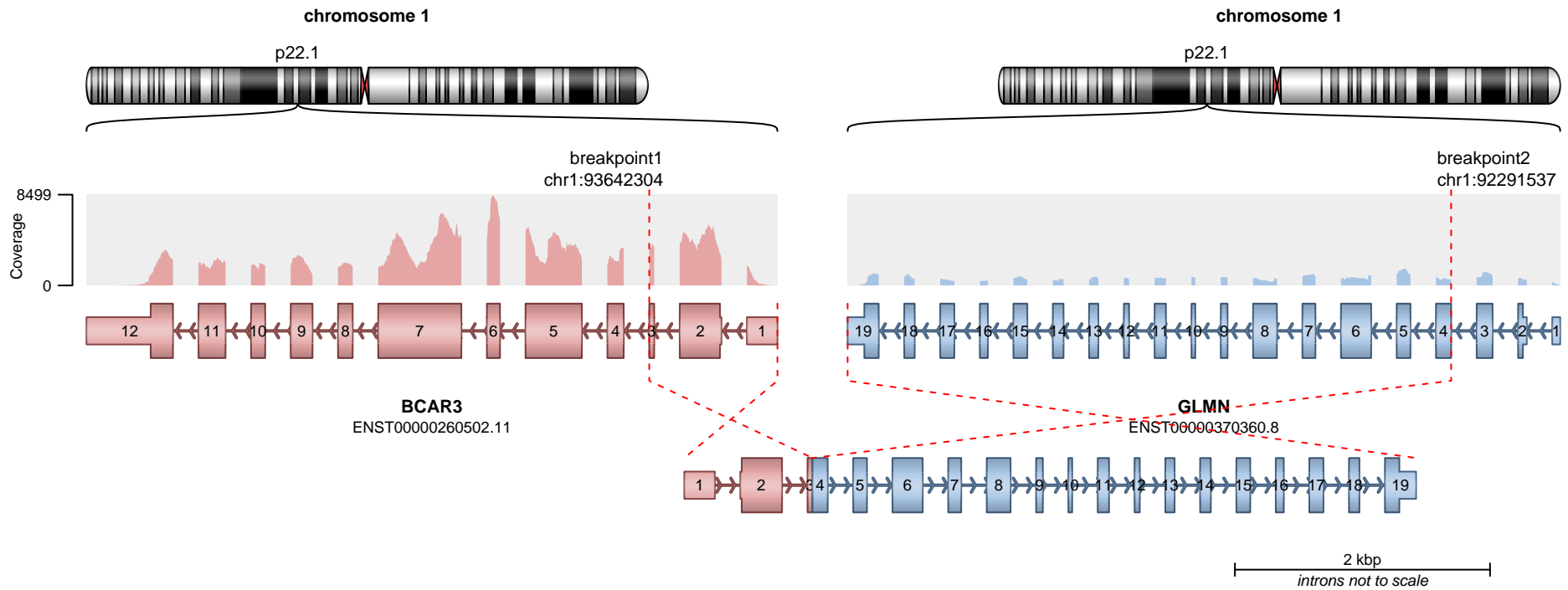

SUPPORTING READ COUNT

Split reads = 2
Discordant mates = 0

- translocation
- duplication
- deletion
- inversion

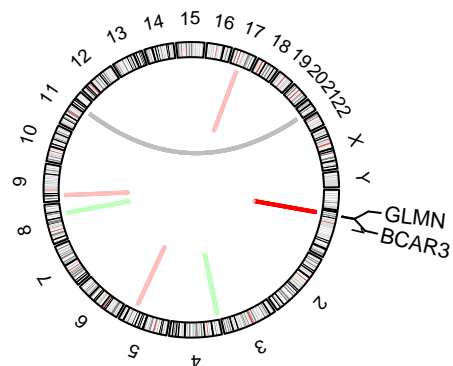
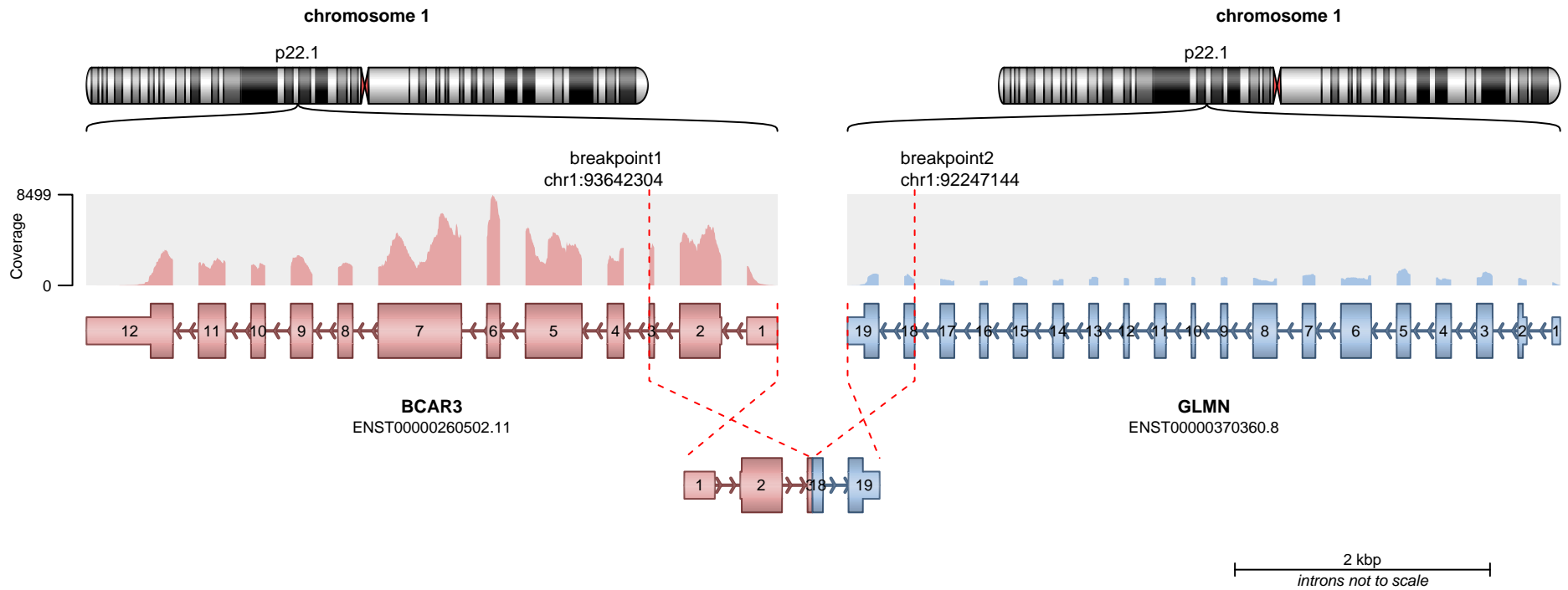

RETAINED PROTEIN DOMAINS
reading frame unclear

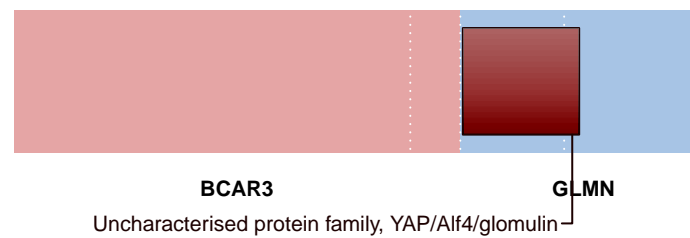

SUPPORTING READ COUNT

Split reads = 1
Discordant mates = 0

- translocation
- duplication
- deletion
- inversion

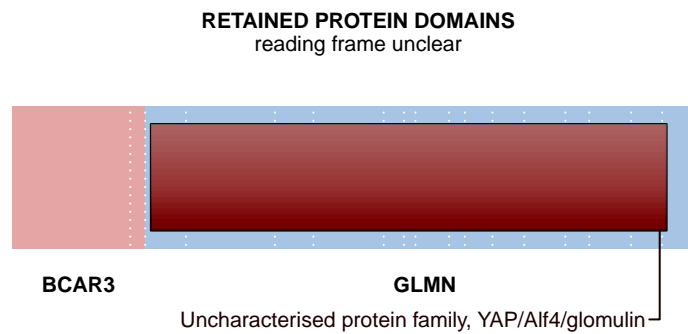
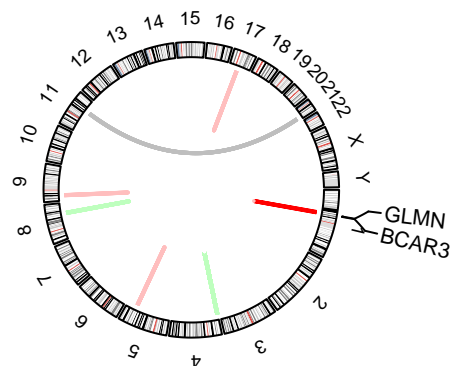
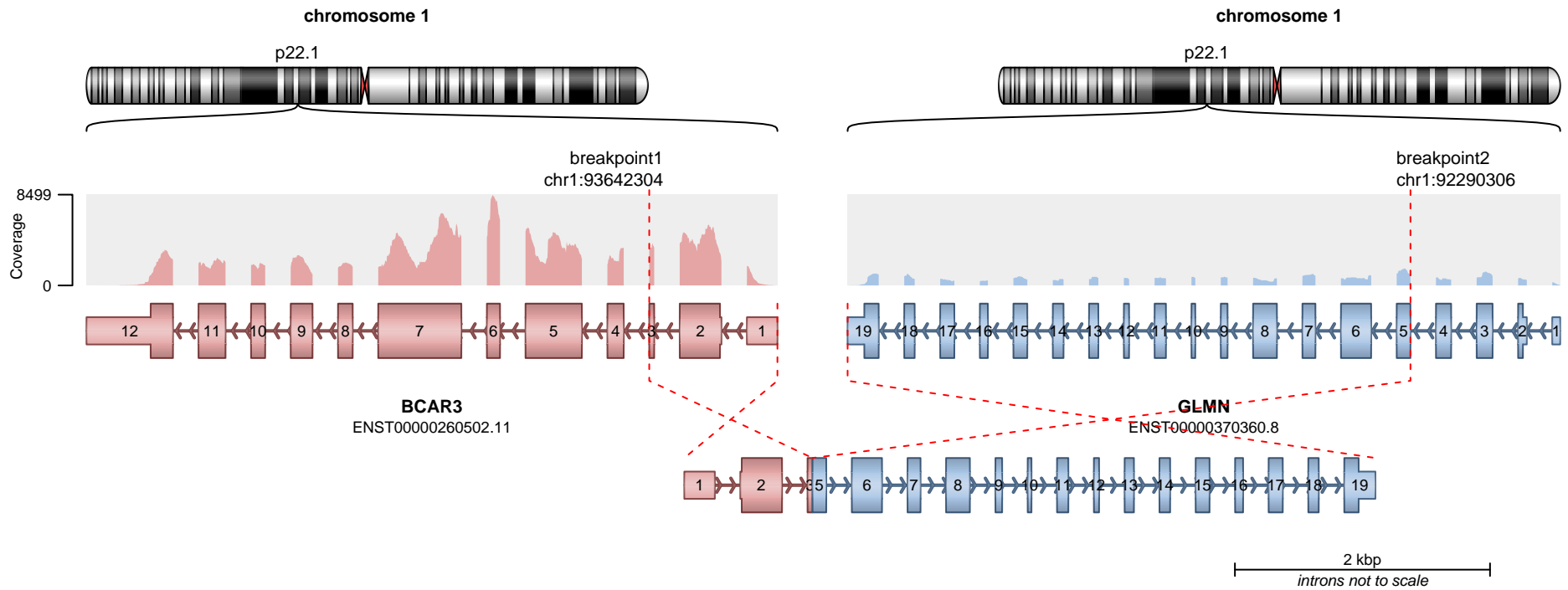

SUPPORTING READ COUNT

Split reads = 1
Discordant mates = 0

- translocation
- duplication
- deletion
- inversion

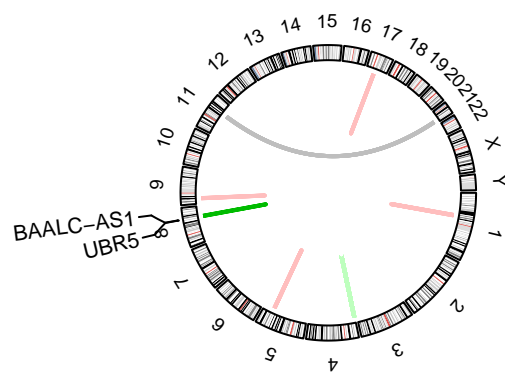
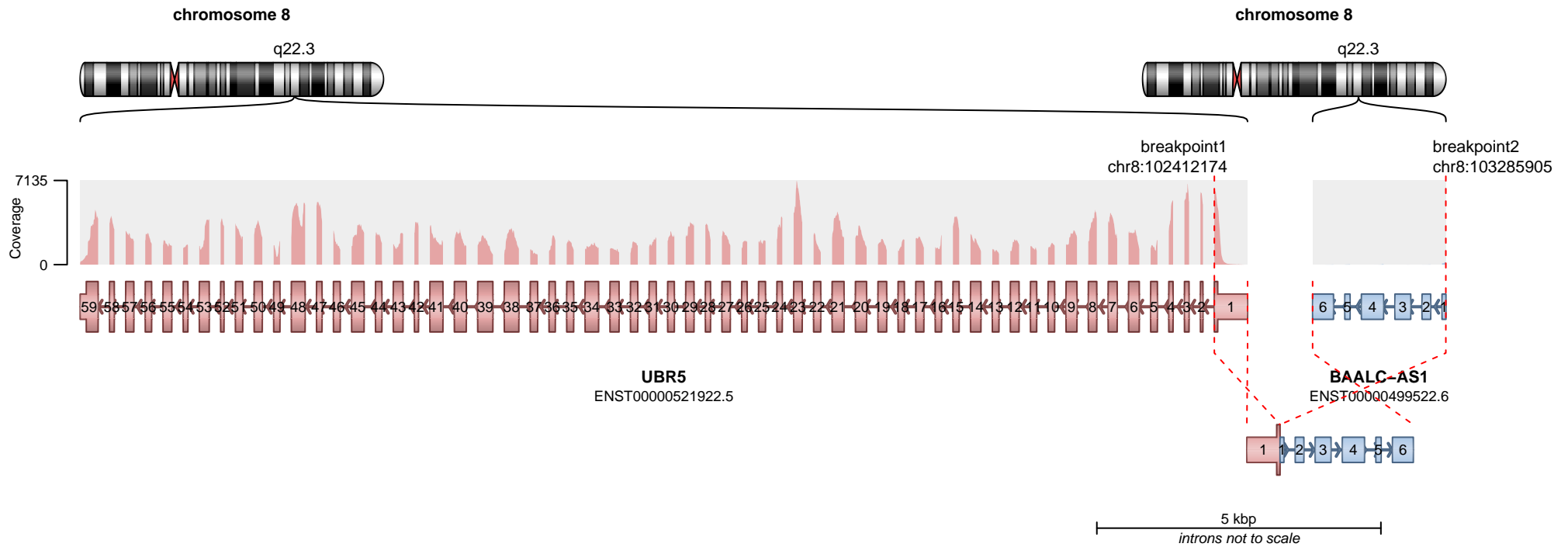

— translocation — deletion
— duplication — inversion

No protein domains retained in fusion.

SUPPORTING READ COUNT

Split reads = 87
Discordant mates = 0

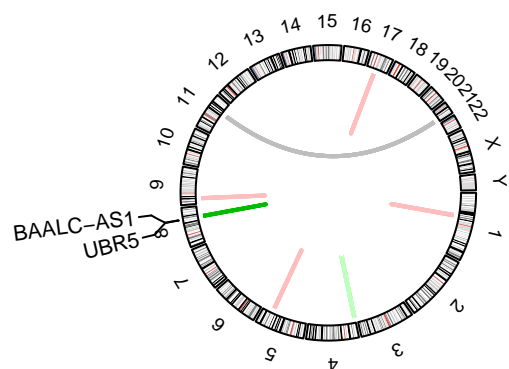
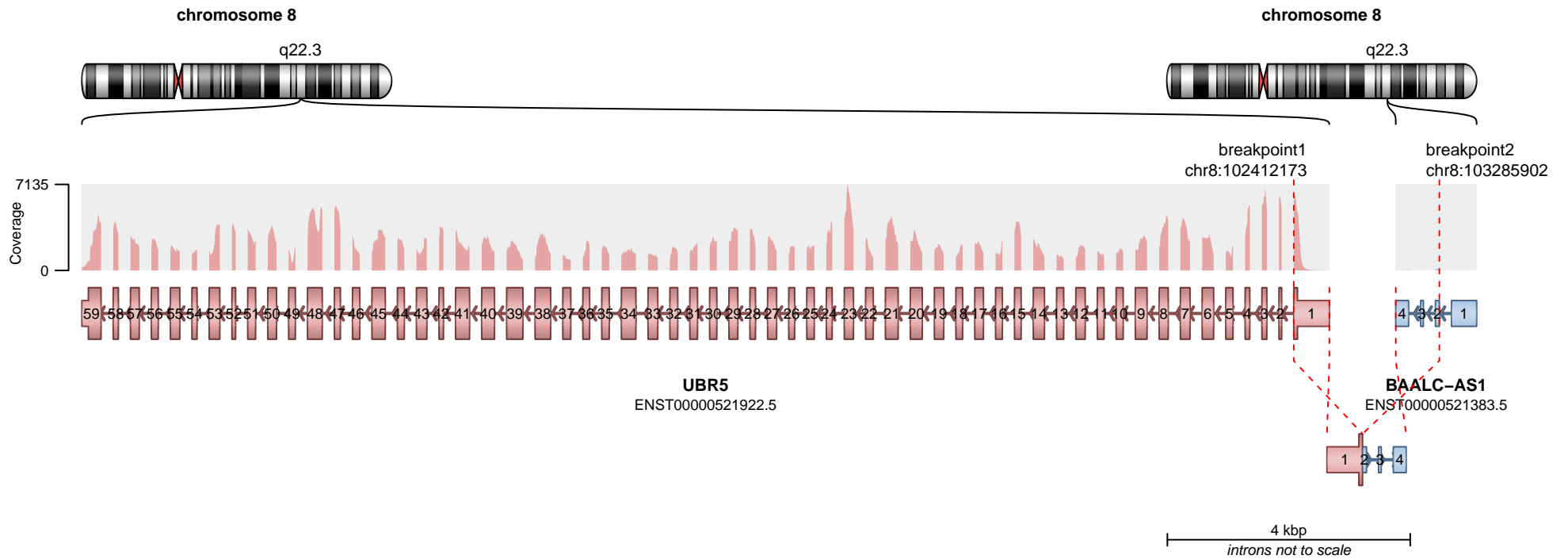

— translocation — deletion
— duplication — inversion

No protein domains retained in fusion.

SUPPORTING READ COUNT

Split reads = 40
Discordant mates = 0

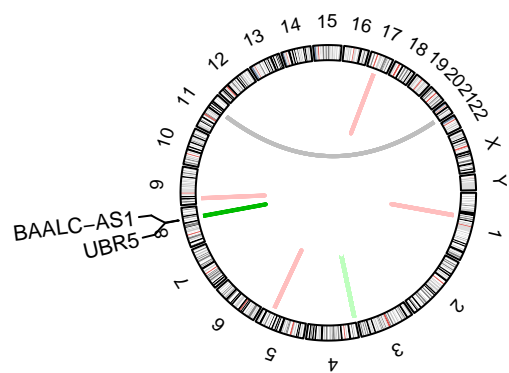
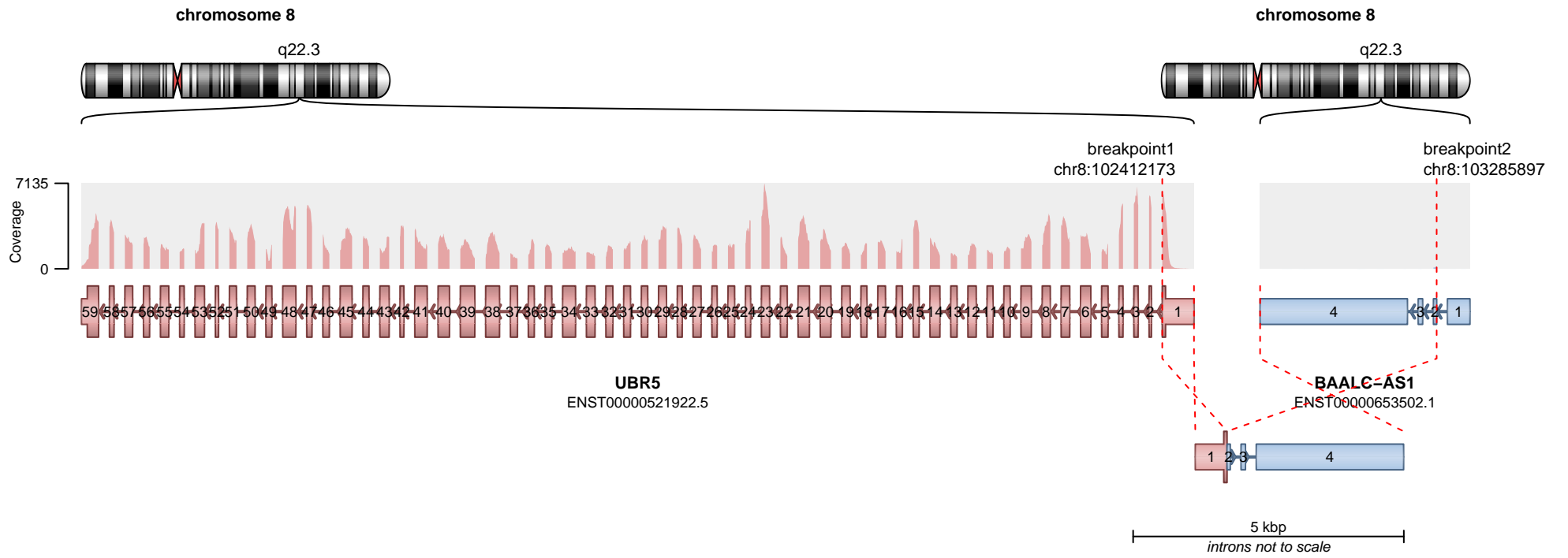

— translocation — deletion
— duplication — inversion

No protein domains retained in fusion.

SUPPORTING READ COUNT

Split reads = 38
Discordant mates = 0

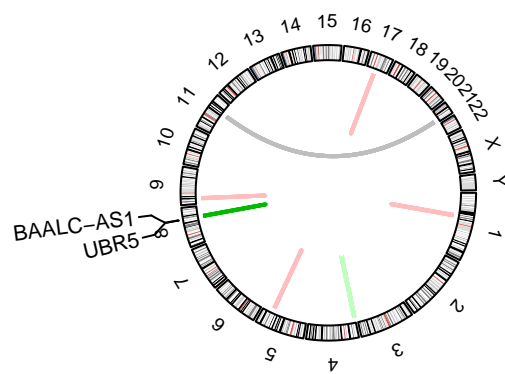
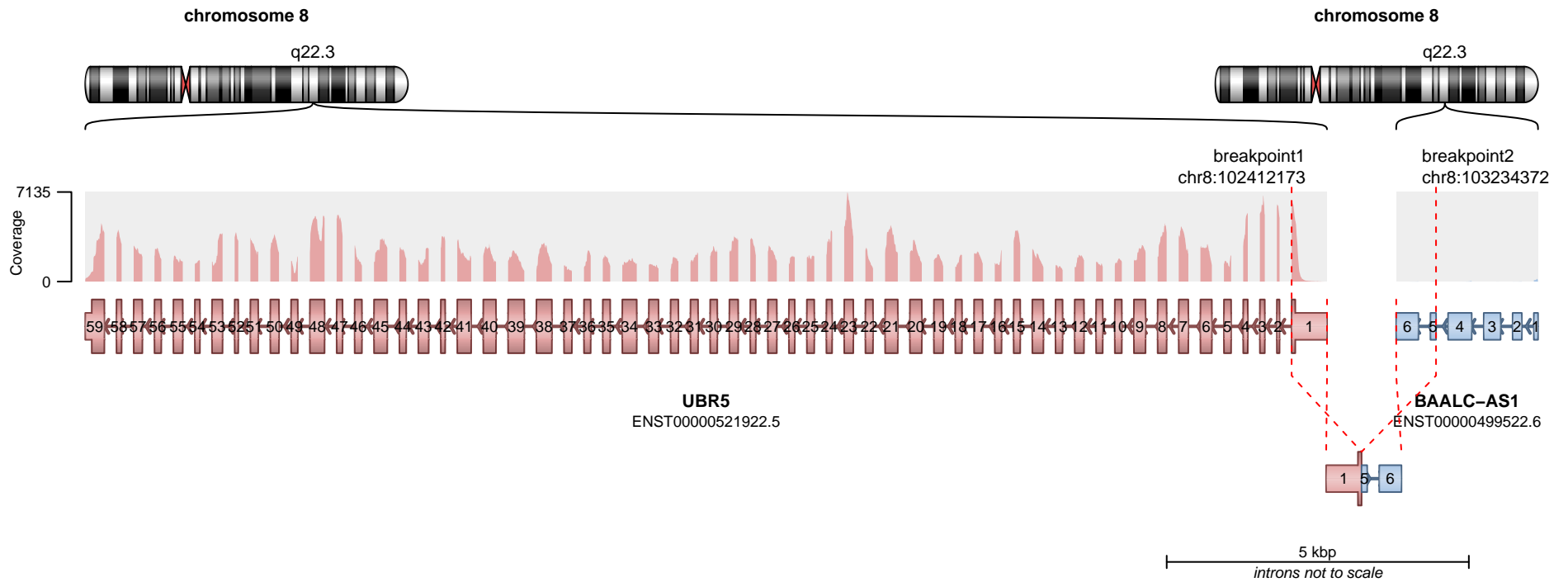

No protein domains retained in fusion.

SUPPORTING READ COUNT

Split reads = 7
Discordant mates = 0

- translocation
- duplication
- deletion
- inversion

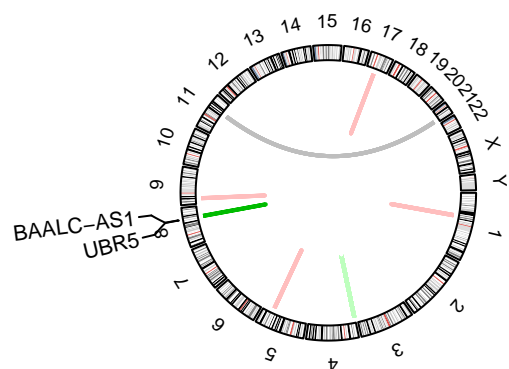
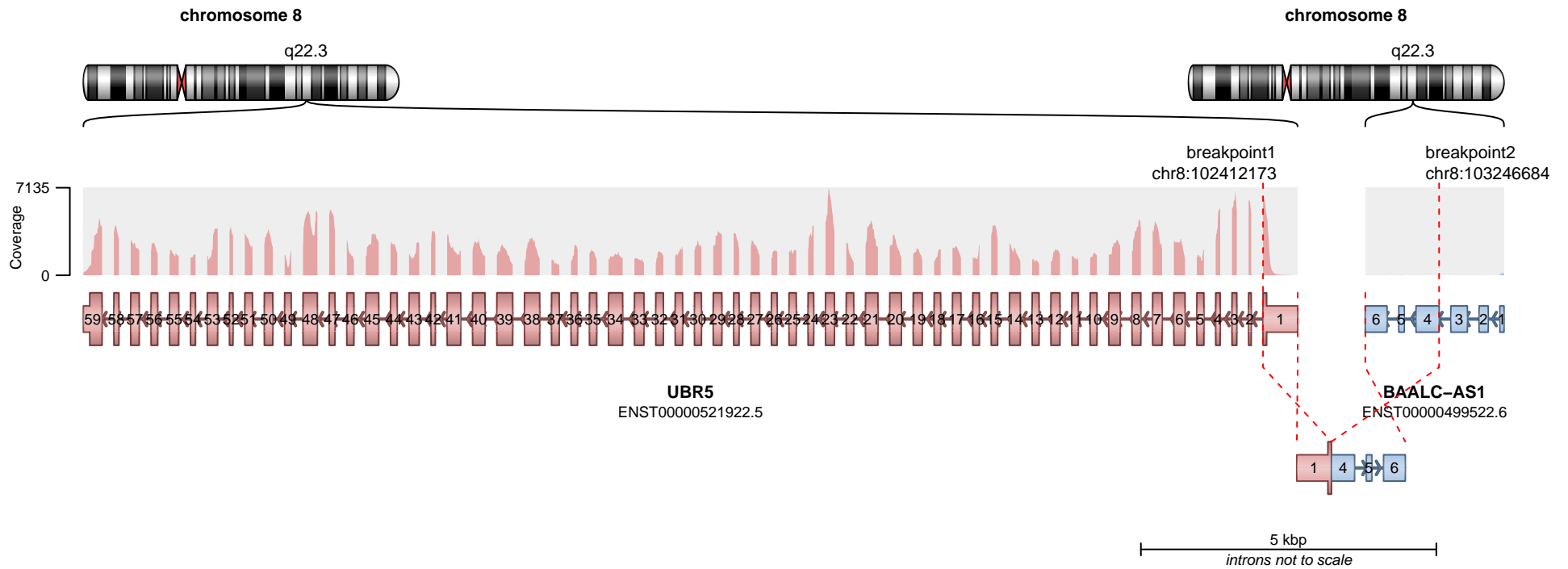

— translocation — deletion
— duplication — inversion

No protein domains retained in fusion.

SUPPORTING READ COUNT

Split reads = 4
Discordant mates = 0

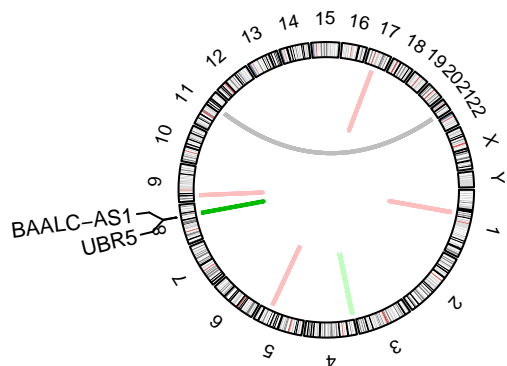
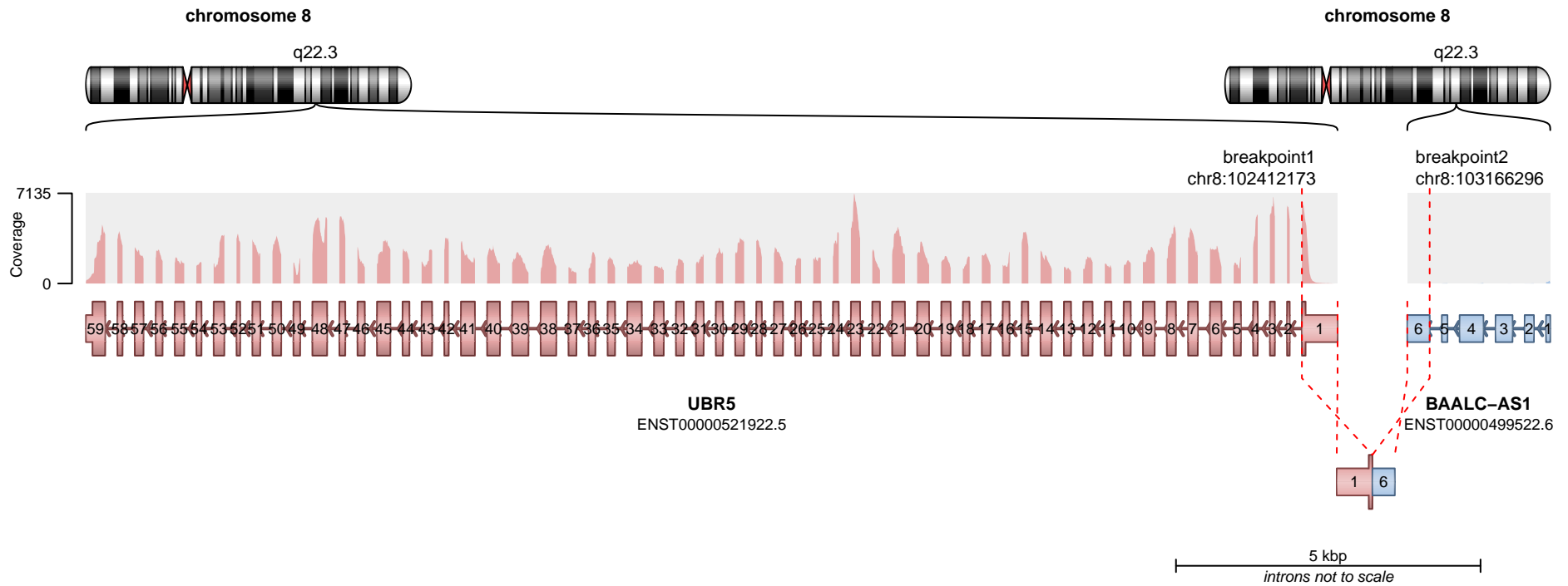

— translocation — deletion
— duplication — inversion

No protein domains retained in fusion.

SUPPORTING READ COUNT

Split reads = 2
Discordant mates = 0

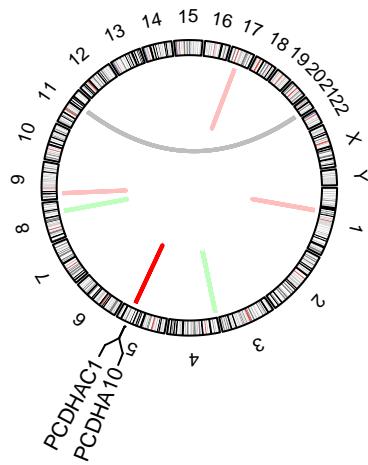
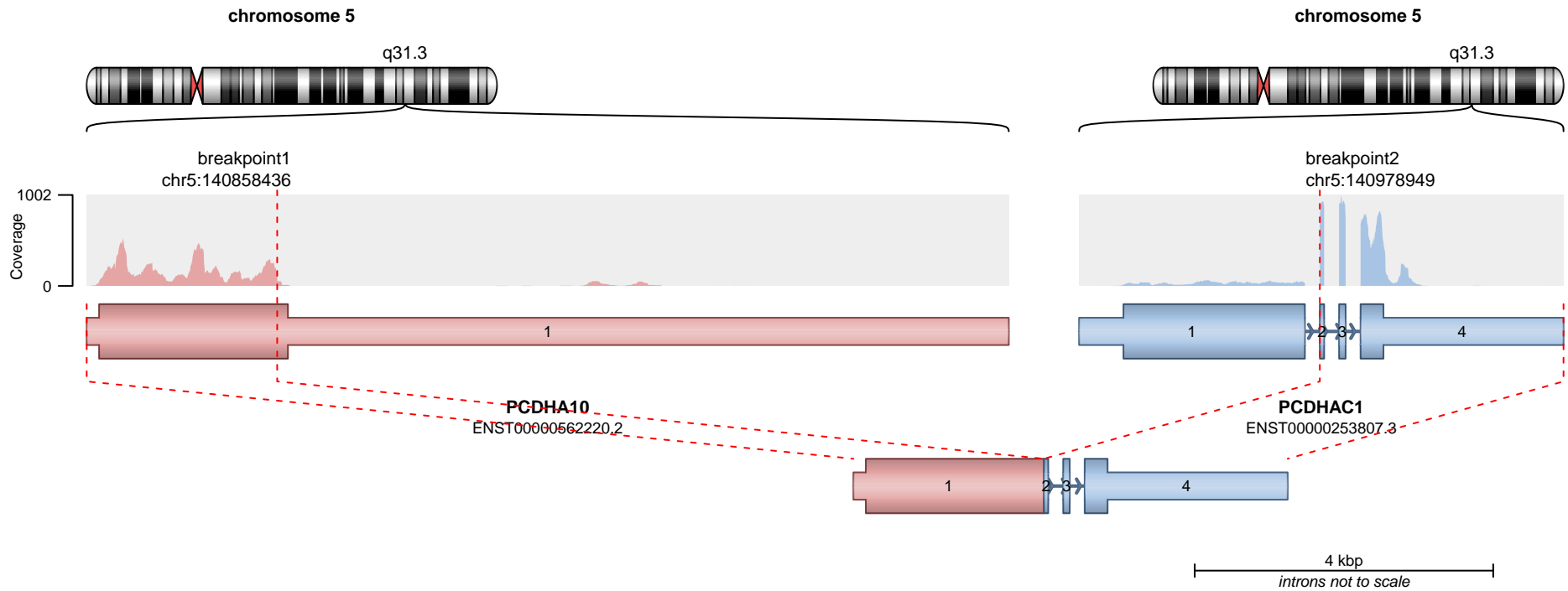

RETAINED PROTEIN DOMAINS
reading frame unclear

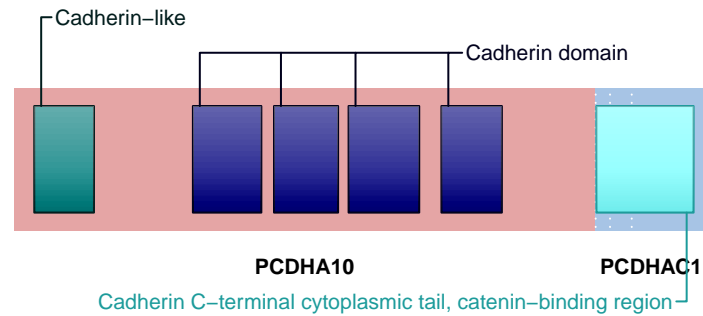

SUPPORTING READ COUNT

Split reads = 38
Discordant mates = 0

— translocation — deletion
— duplication — inversion

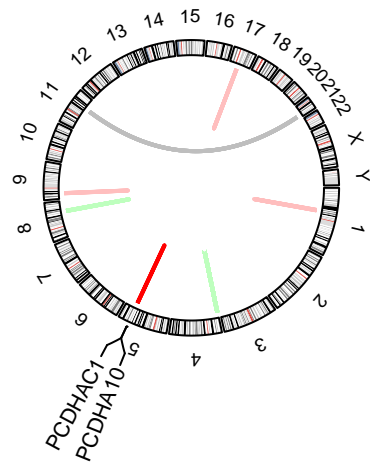
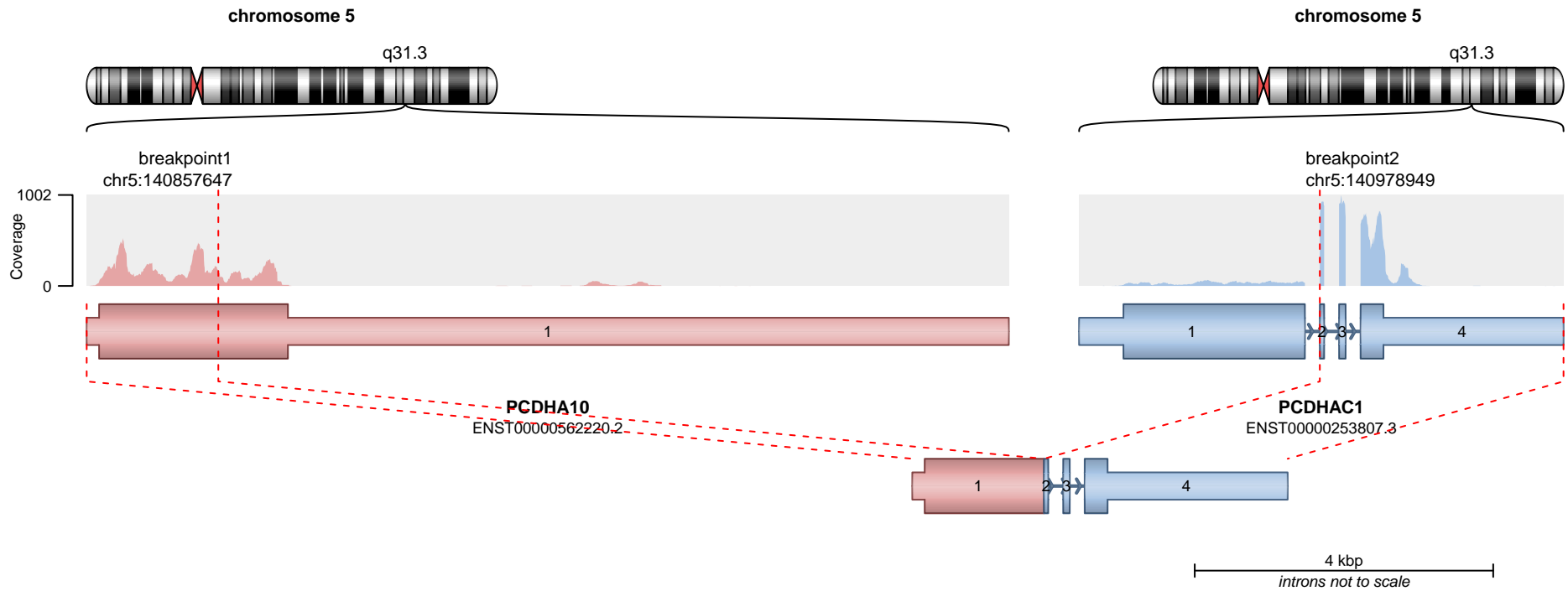

RETAINED PROTEIN DOMAINS
reading frame unclear

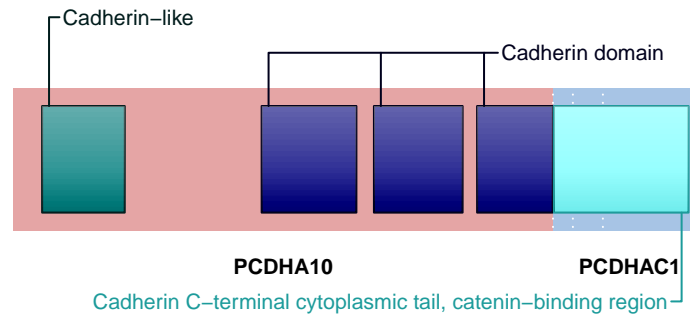

SUPPORTING READ COUNT

Split reads = 9
Discordant mates = 0

— translocation — deletion
— duplication — inversion

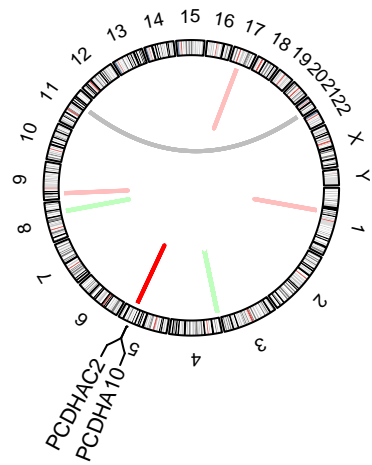
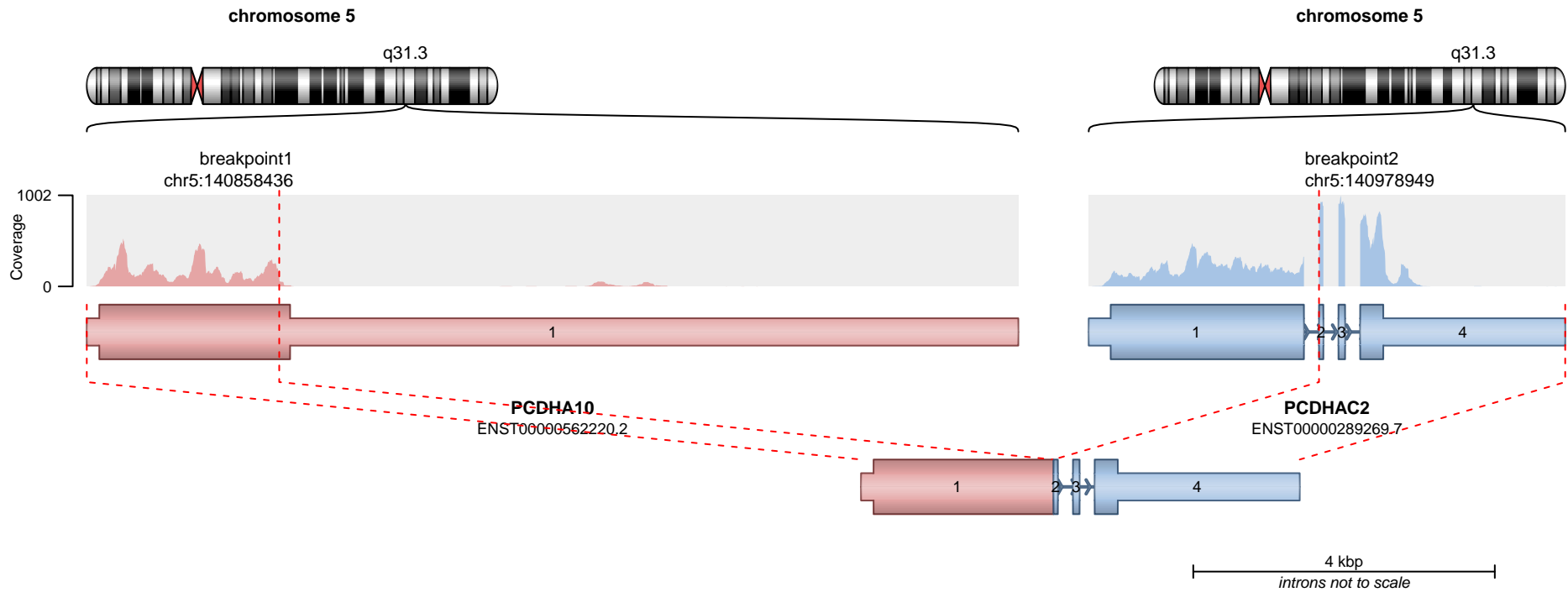

RETAINED PROTEIN DOMAINS
reading frame unclear

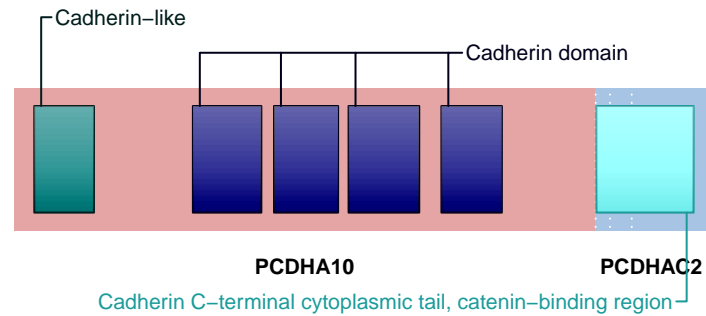

SUPPORTING READ COUNT

Split reads = 38
Discordant mates = 0

— translocation — deletion
— duplication — inversion

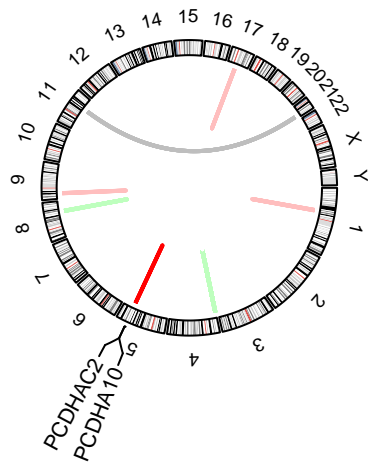
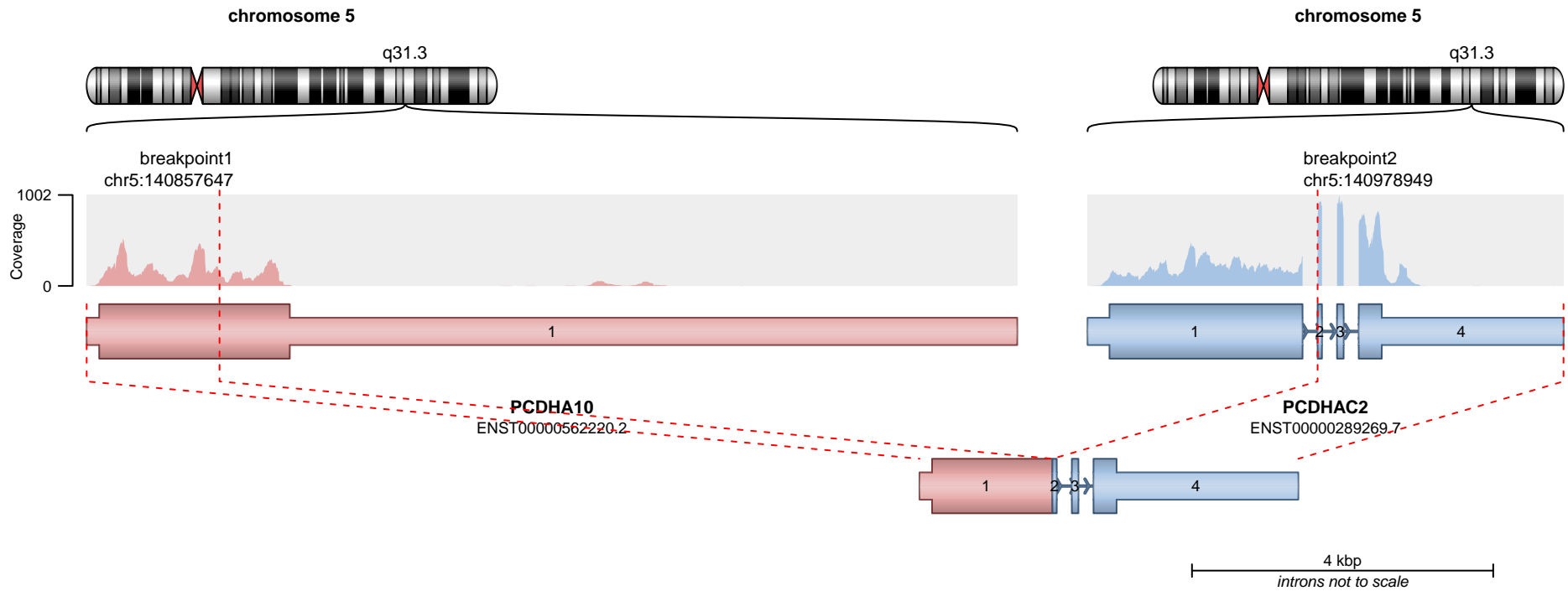

RETAINED PROTEIN DOMAINS
reading frame unclear

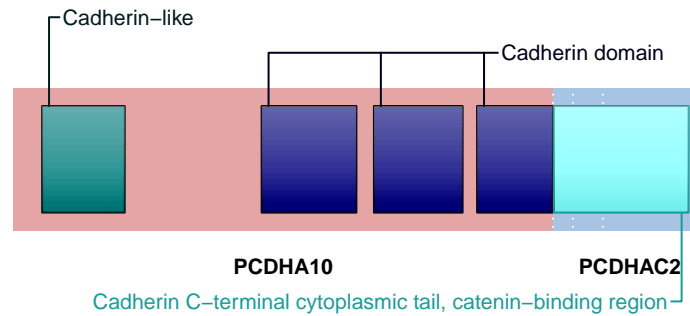

SUPPORTING READ COUNT

Split reads = 9
Discordant mates = 0

— translocation — deletion
— duplication — inversion

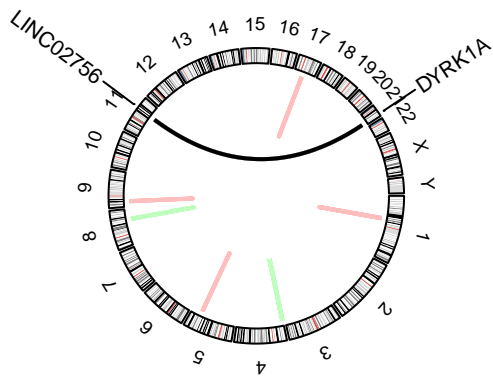
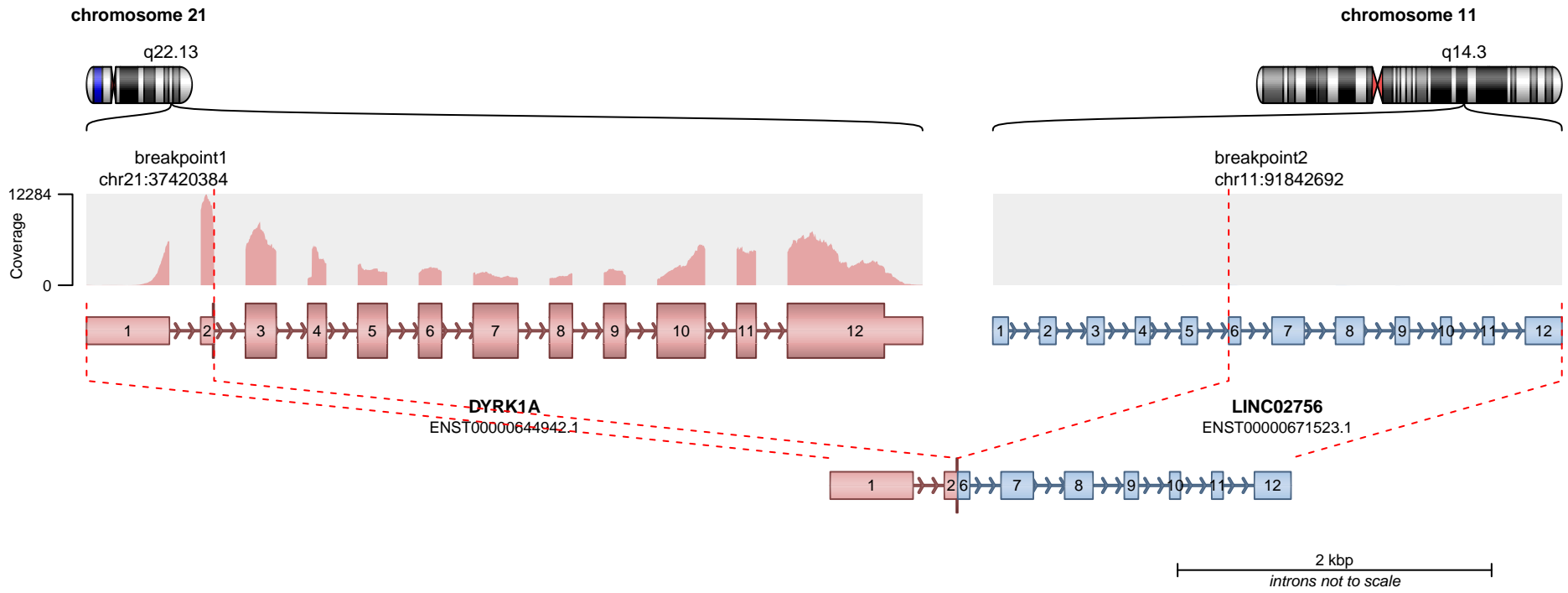

No protein domains retained in fusion.

SUPPORTING READ COUNT

Split reads = 27
Discordant mates = 0

- translocation
- duplication
- deletion
- inversion

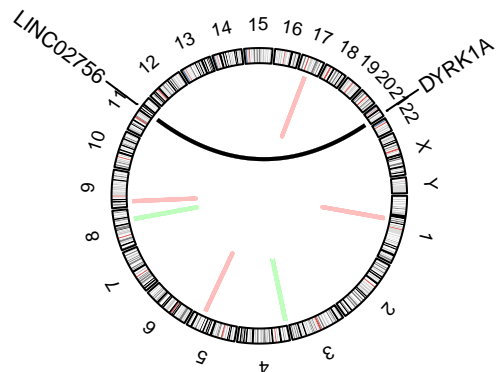
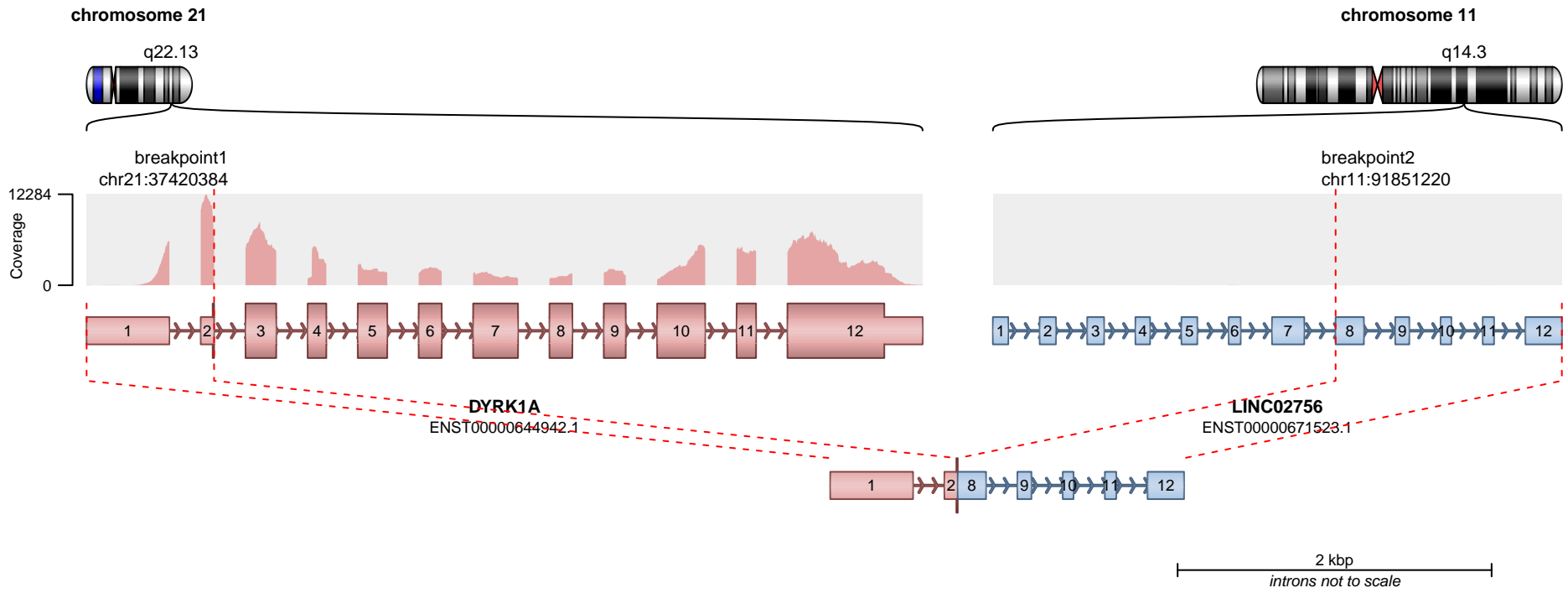

No protein domains retained in fusion.

SUPPORTING READ COUNT

Split reads = 11
Discordant mates = 0

— translocation — deletion
— duplication — inversion

chromosome 21



chromosome 11

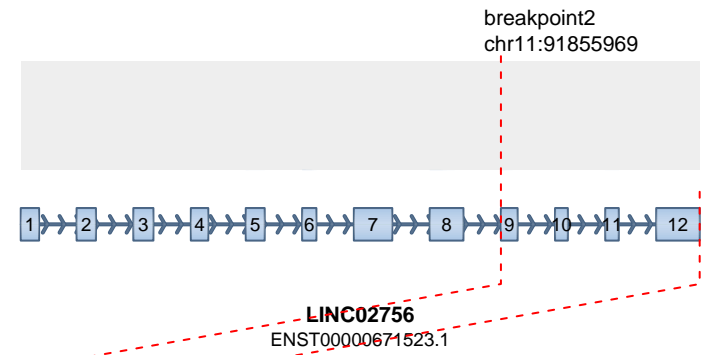
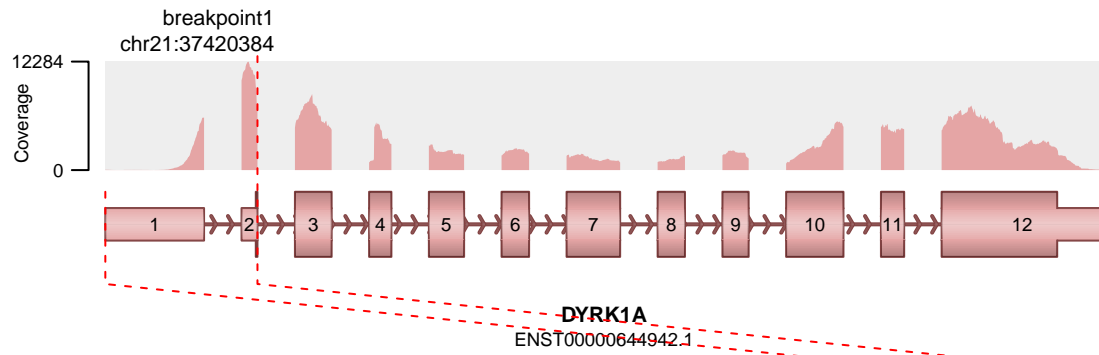

2 kbp
introns not to scale

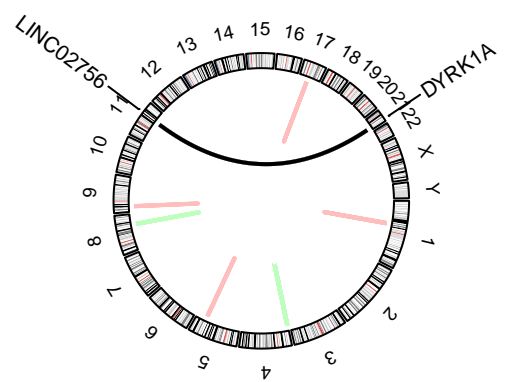

No protein domains retained in fusion.

SUPPORTING READ COUNT

Split reads = 2
Discordant mates = 0

- translocation
- duplication
- deletion
- inversion

chromosome 21



chromosome 11

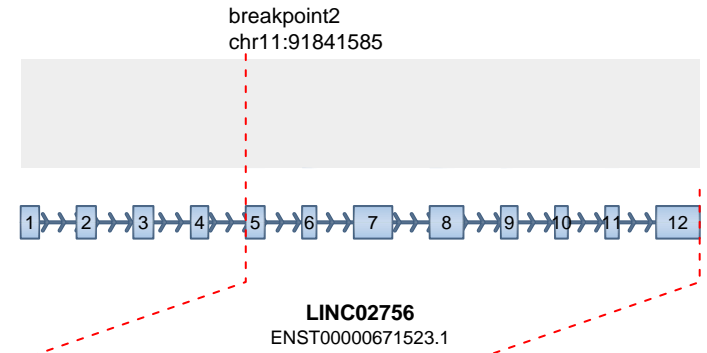
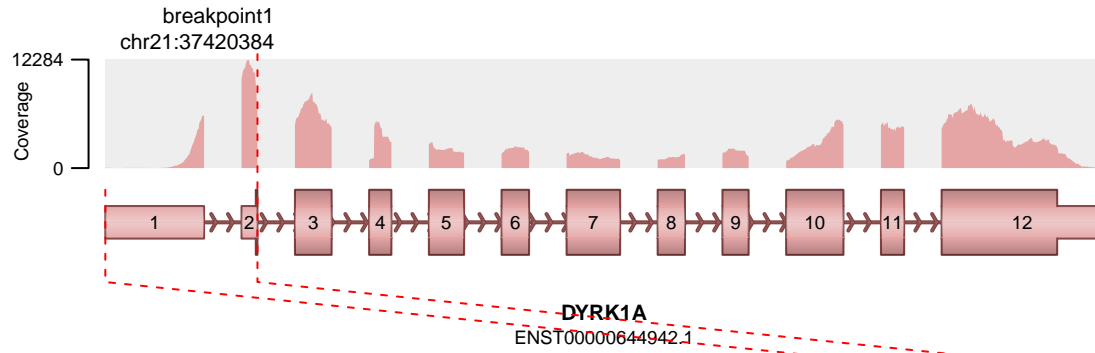

2 kbp
introns not to scale

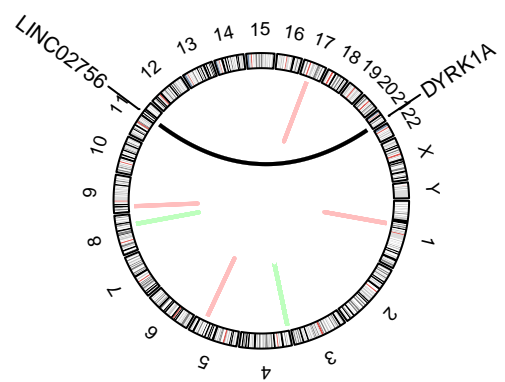

— translocation — deletion
— duplication — inversion

No protein domains retained in fusion.

SUPPORTING READ COUNT

Split reads = 2
Discordant mates = 0

chromosome 21



chromosome 11

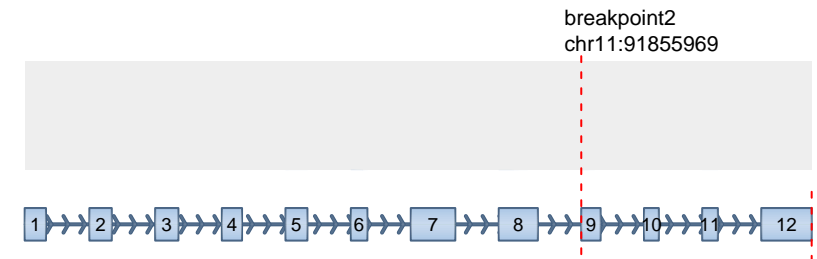
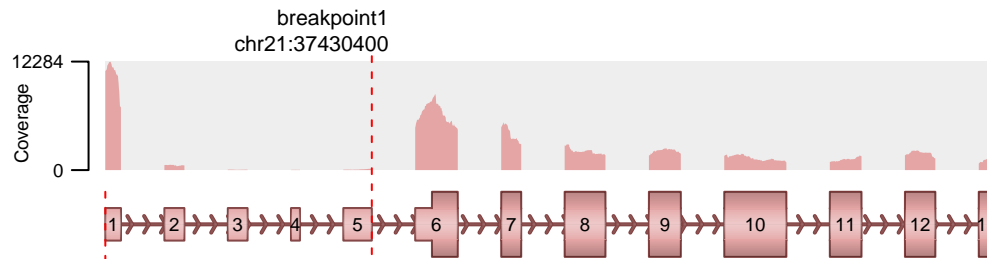

DYRK1A
ENST00000642309.1

LINC02756
ENST00000671523.1

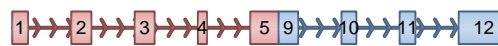

2 kbp
introns not to scale

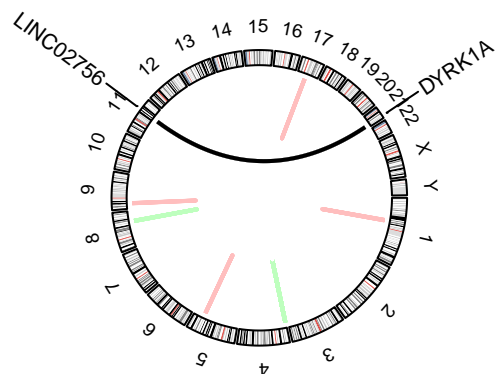

No coding regions retained in fusion transcript.

SUPPORTING READ COUNT

Split reads = 1
Discordant mates = 0

— translocation — deletion
— duplication — inversion

chromosome 21



chromosome 11

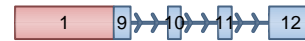
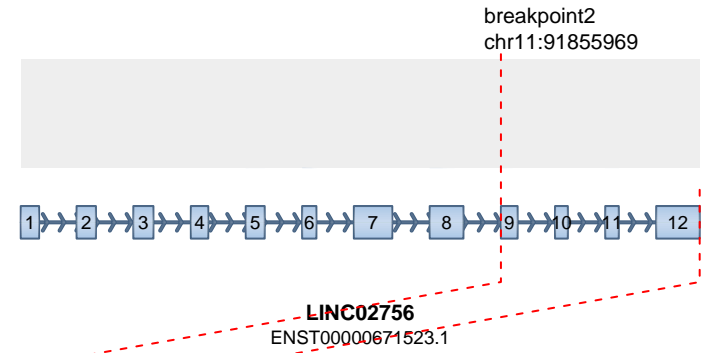
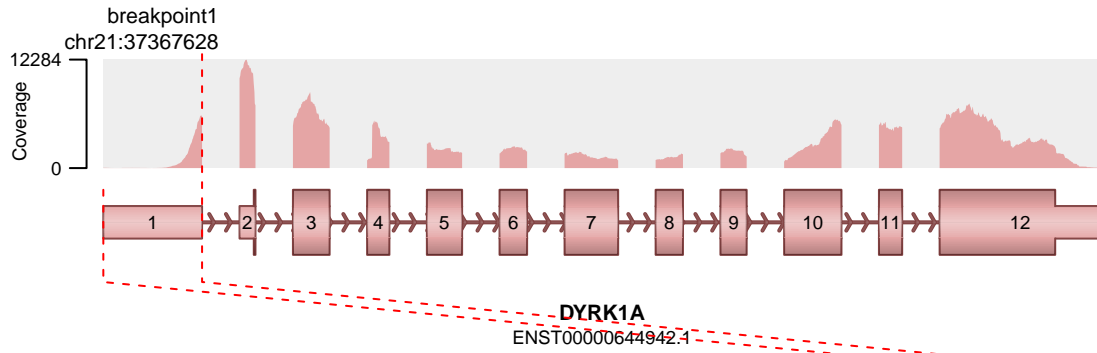

2 kbp
introns not to scale

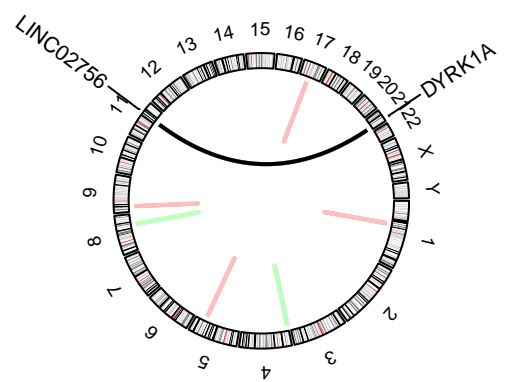

No coding regions retained in fusion transcript.

SUPPORTING READ COUNT

Split reads = 1
Discordant mates = 0

- translocation
- duplication
- deletion
- inversion

chromosome 21



chromosome 11

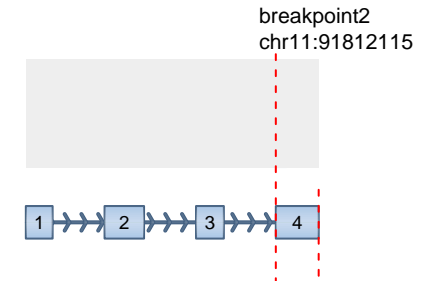
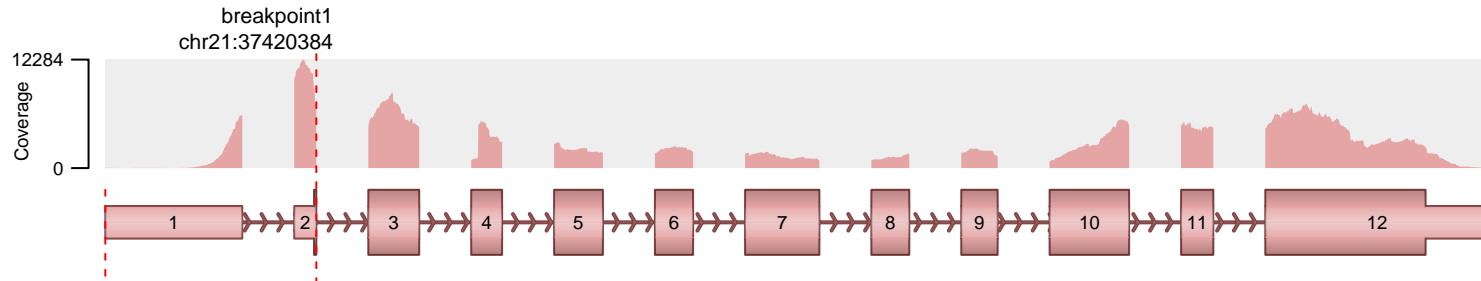

DYRK1A
ENST00000644942.1

LINC02756
ENST00000655162.1

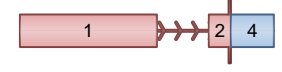

1 kbp
introns not to scale

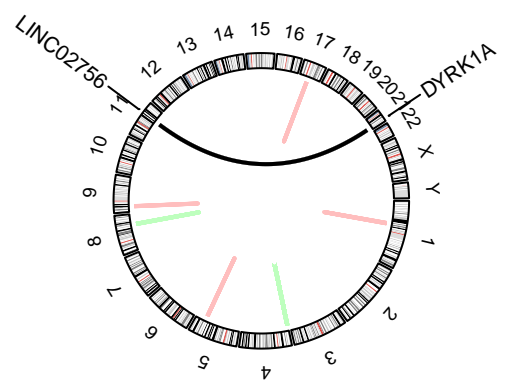

No protein domains retained in fusion.

SUPPORTING READ COUNT

Split reads = 1
Discordant mates = 0

- translocation
- duplication
- deletion
- inversion

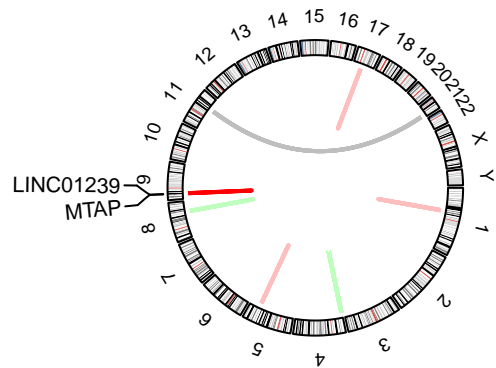
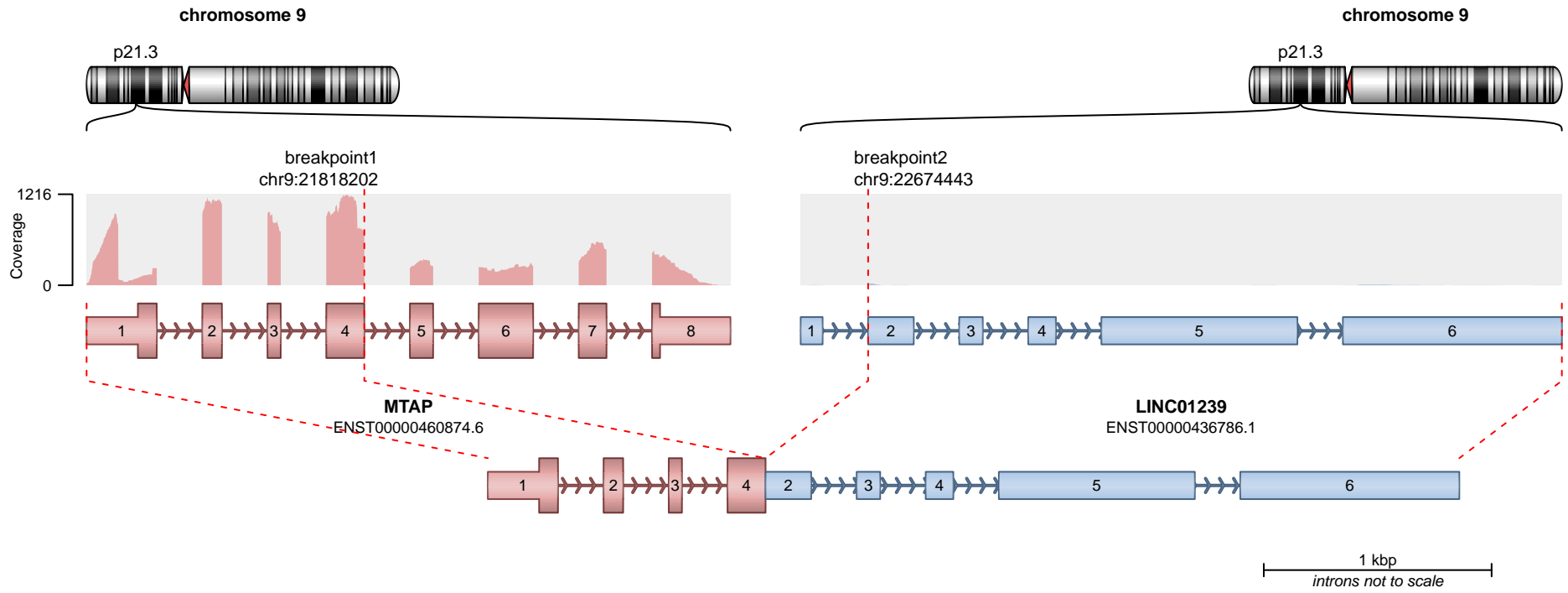

RETAINED PROTEIN DOMAINS
reading frame unclear

Phosphorylase superfamily



MTAP

SUPPORTING READ COUNT

Split reads = 16
Discordant mates = 0

- translocation
- duplication
- deletion
- inversion

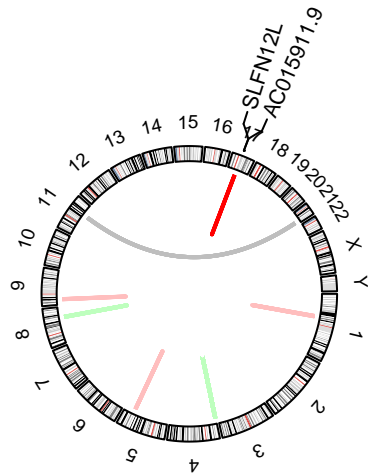
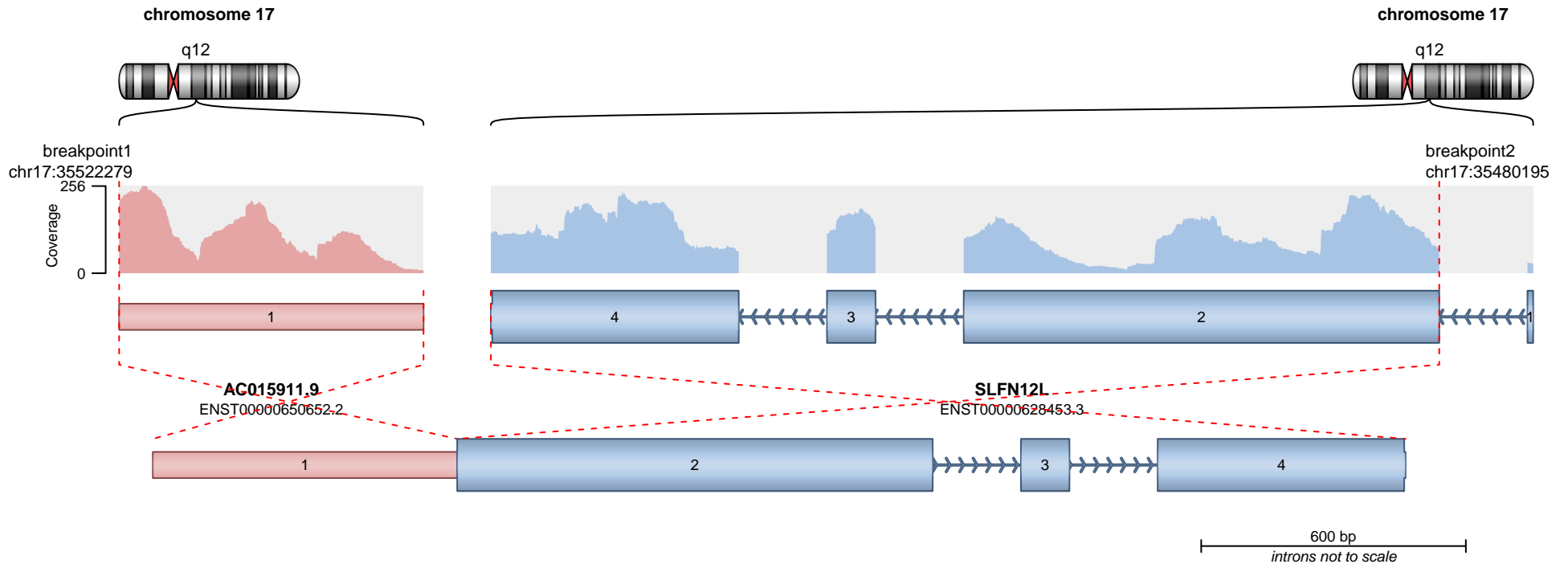

RETAINED PROTEIN DOMAINS
reading frame unclear

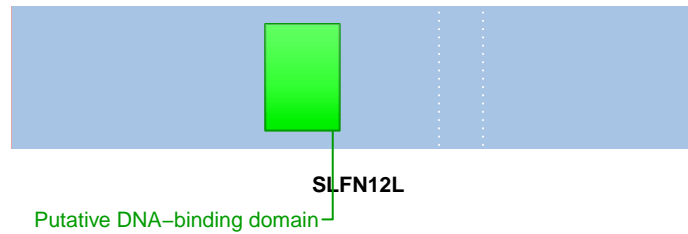

SUPPORTING READ COUNT

Split reads = 11
Discordant mates = 1

— translocation — deletion
— duplication — inversion

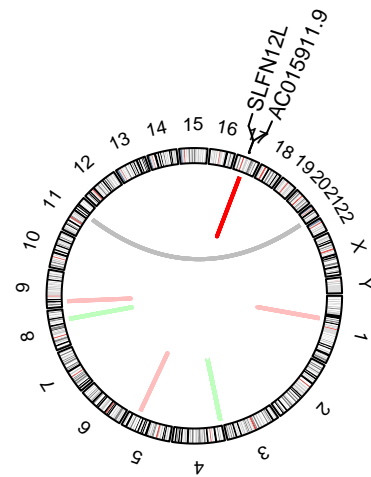
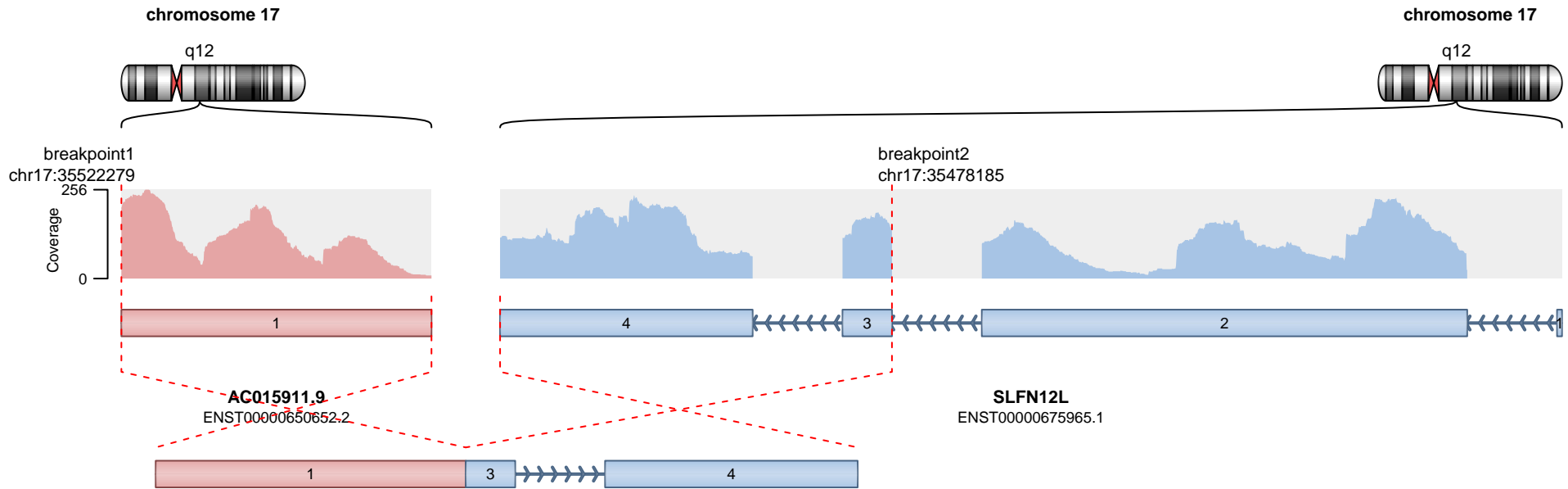

— translocation — deletion
— duplication — inversion

Genes are not protein-coding.

SUPPORTING READ COUNT

Split reads = 5
Discordant mates = 0

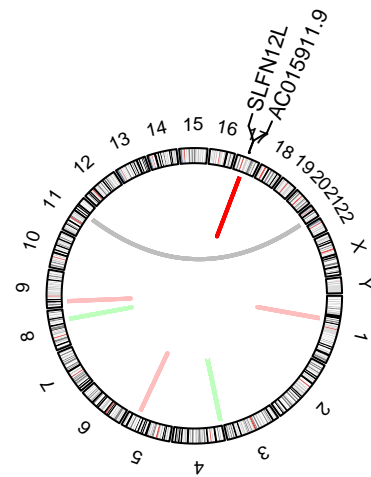
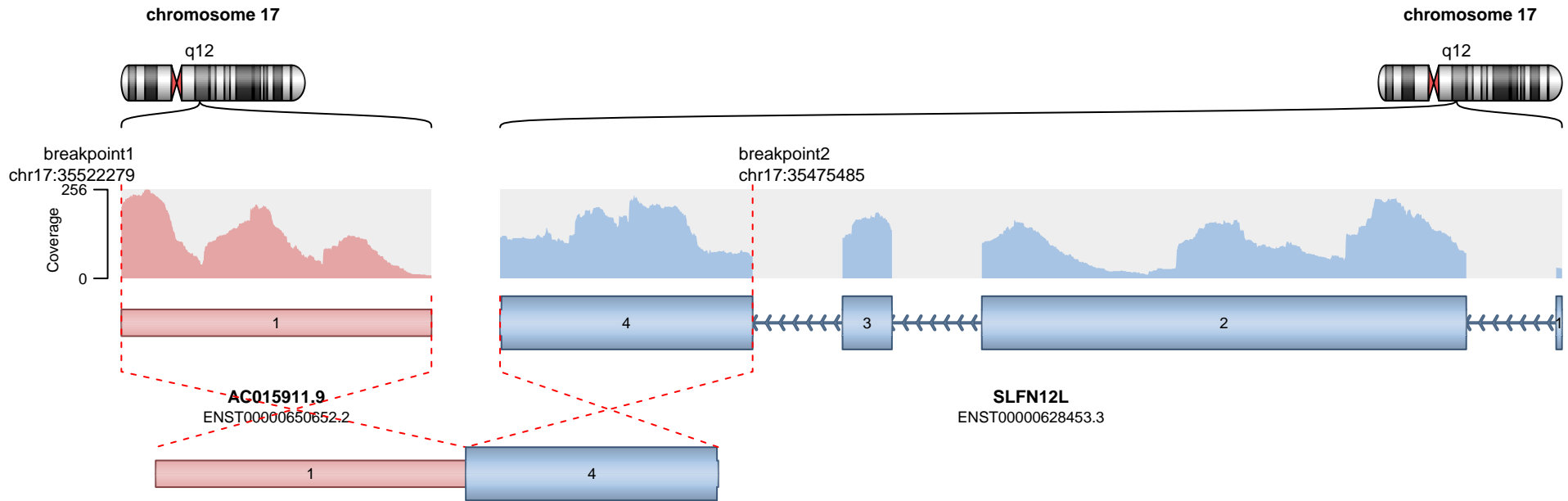

— translocation — deletion
— duplication — inversion

No protein domains retained in fusion.

SUPPORTING READ COUNT

Split reads = 2
Discordant mates = 0