

RETAINED PROTEIN DOMAINS
reading frame unclear



SUPPORTING READ COUNT

Split reads = 3684
Discordant mates = 132

- translocation
- duplication
- deletion
- inversion

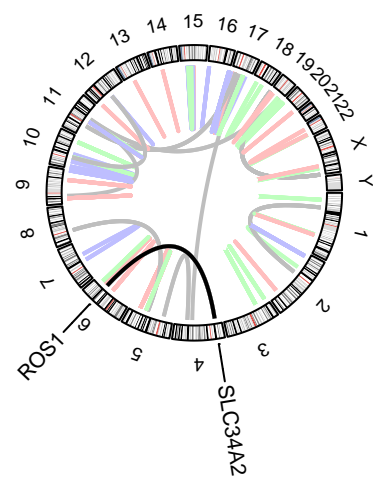
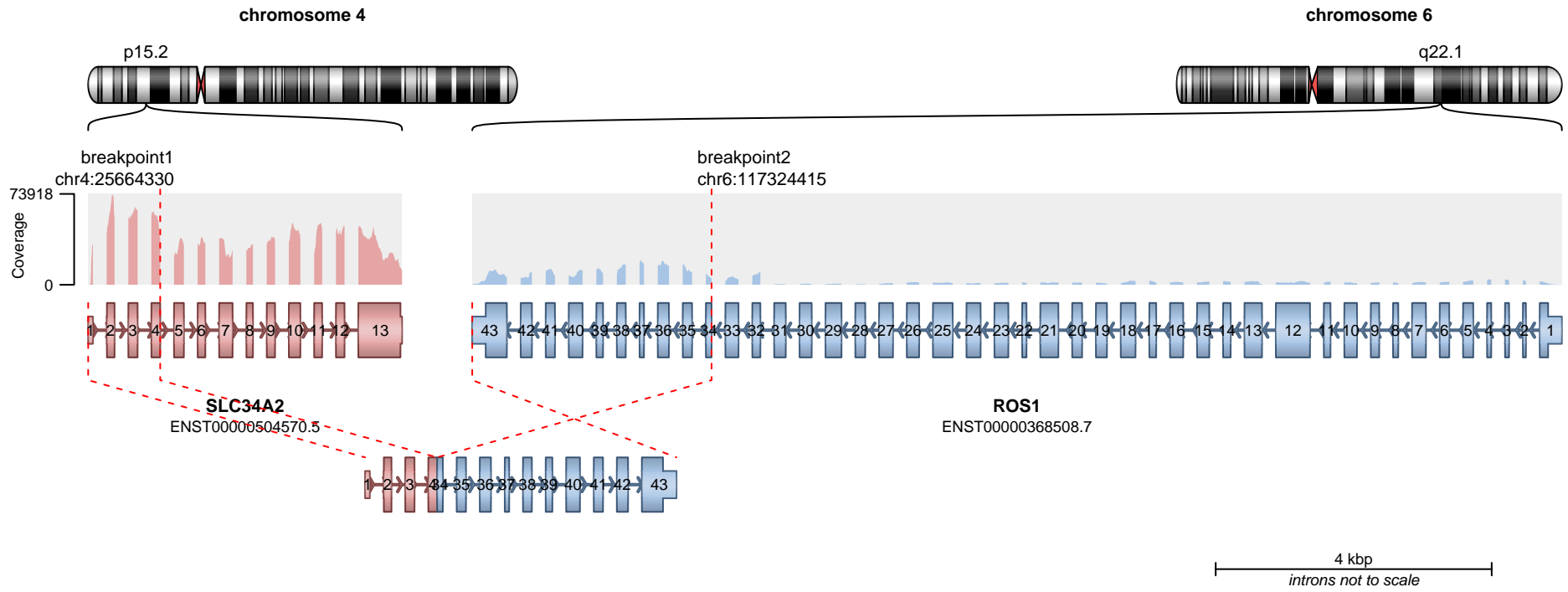

RETAINED PROTEIN DOMAINS
reading frame unclear



SUPPORTING READ COUNT

Split reads = 455
Discordant mates = 42

- translocation
- duplication
- deletion
- inversion

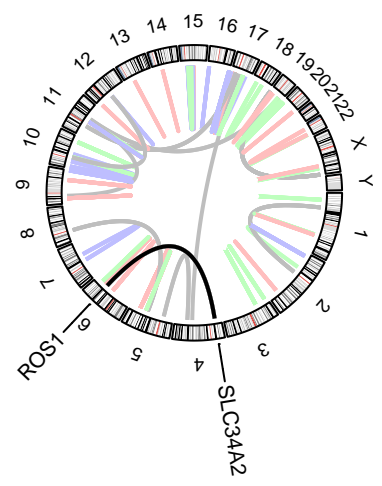
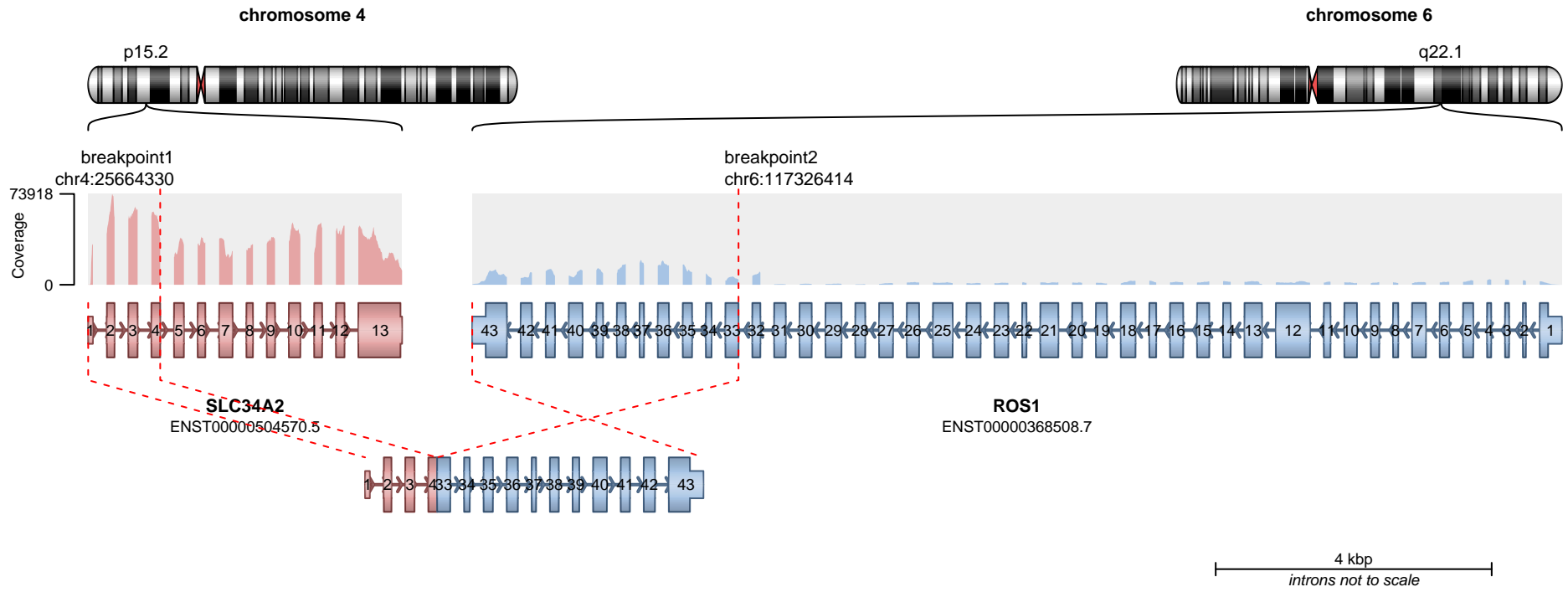

RETAINED PROTEIN DOMAINS
reading frame unclear



SUPPORTING READ COUNT

Split reads = 70
Discordant mates = 46

- translocation
- duplication
- deletion
- inversion

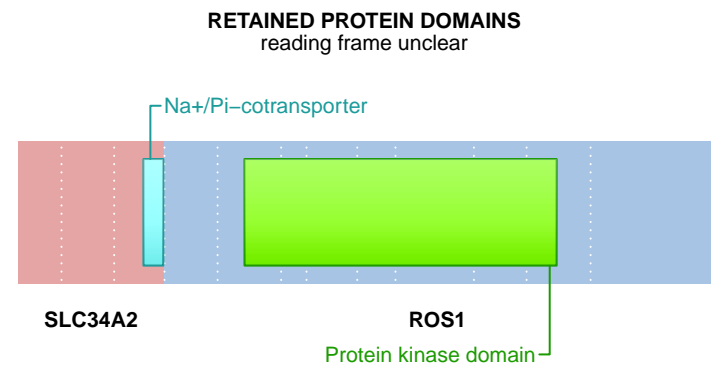
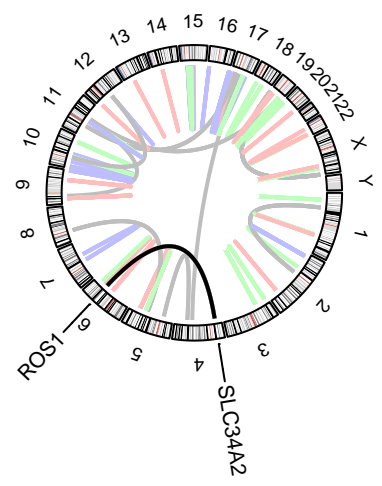
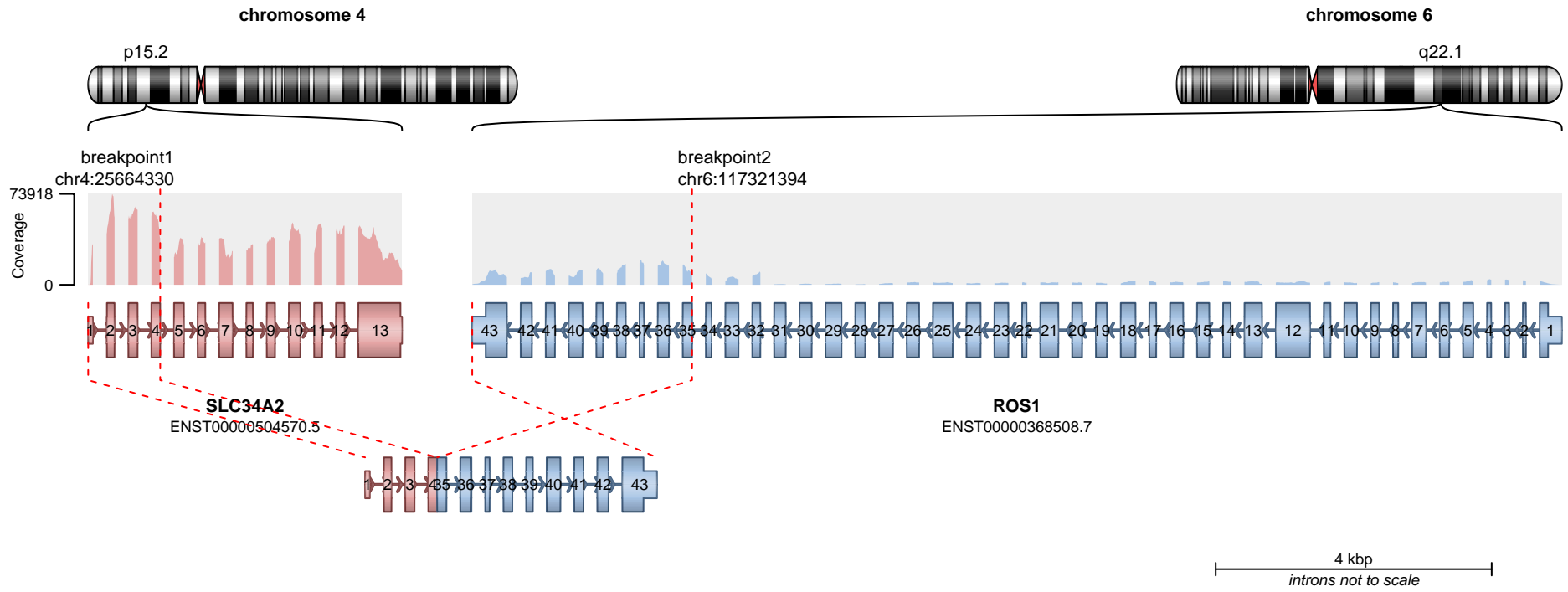

SUPPORTING READ COUNT

Split reads = 14
Discordant mates = 6

— translocation — deletion
— duplication — inversion

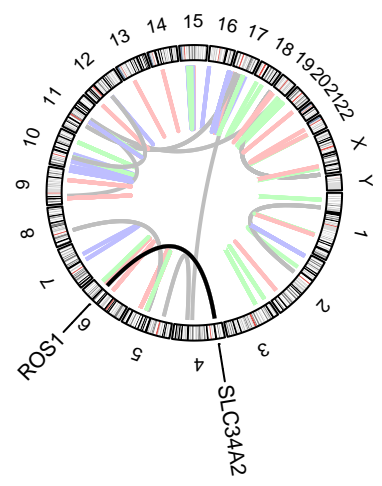
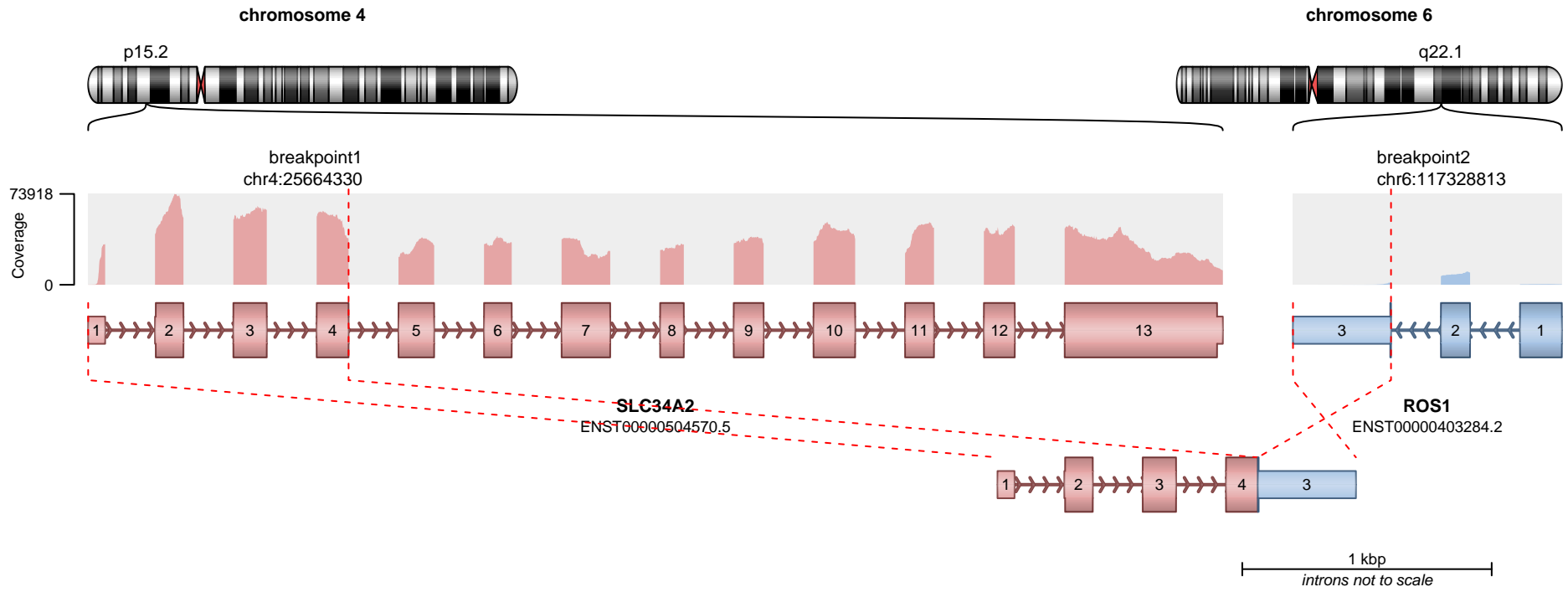

RETAINED PROTEIN DOMAINS
reading frame unclear

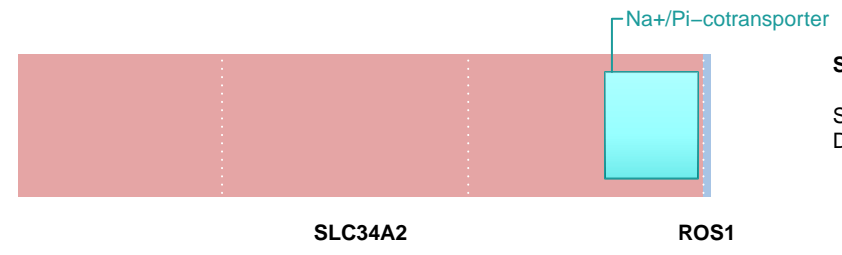

SUPPORTING READ COUNT

Split reads = 1
Discordant mates = 47

- translocation
- duplication
- deletion
- inversion

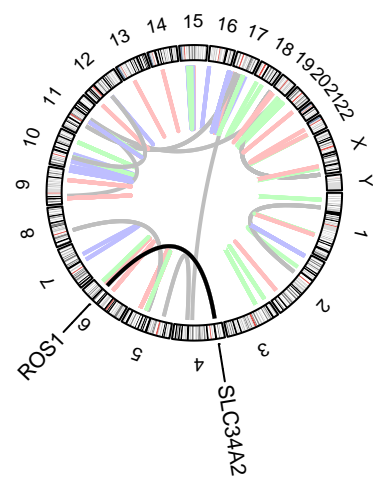
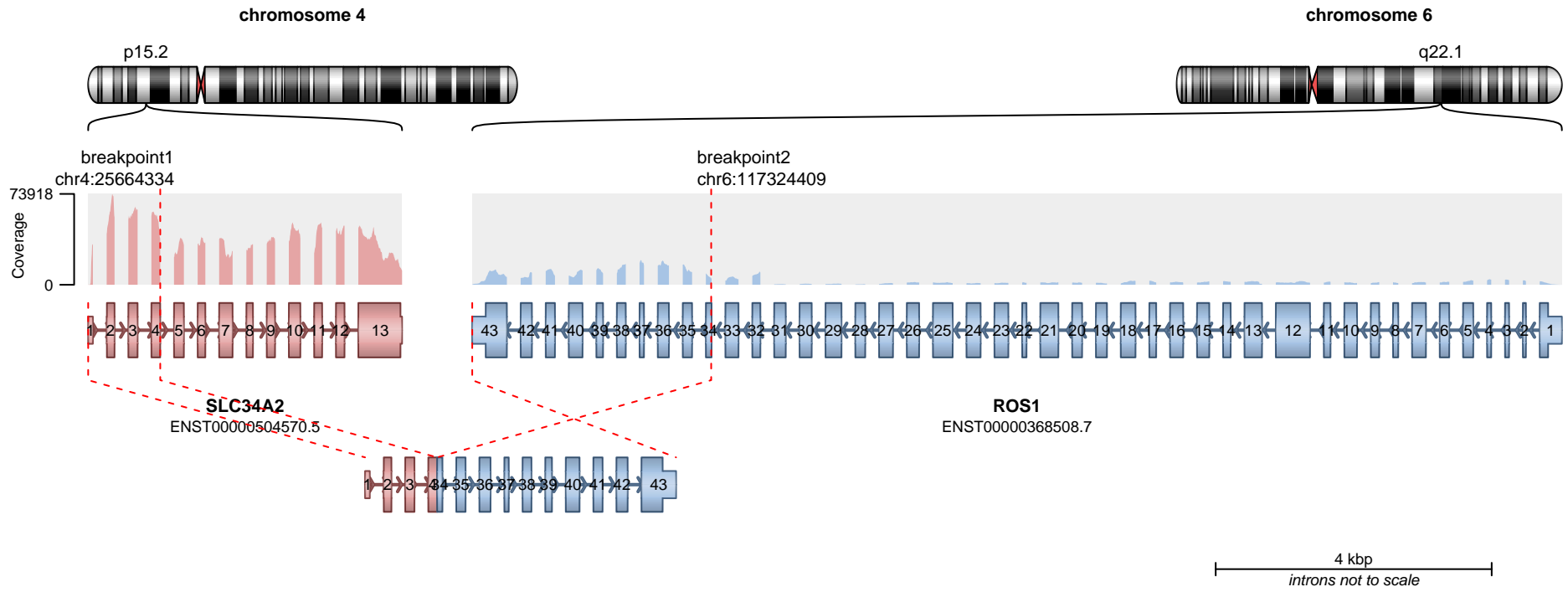

RETAINED PROTEIN DOMAINS
reading frame unclear

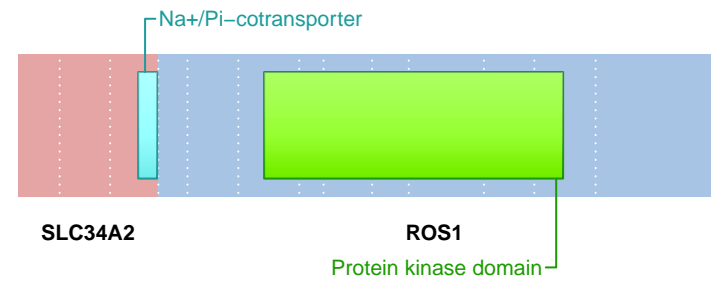

SUPPORTING READ COUNT

Split reads = 3
Discordant mates = 25

- translocation
- duplication
- deletion
- inversion

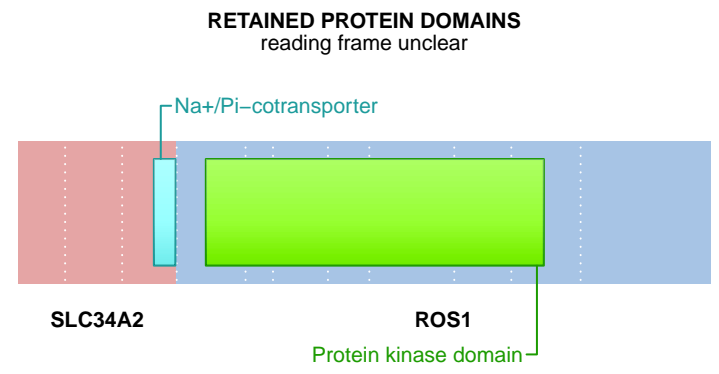
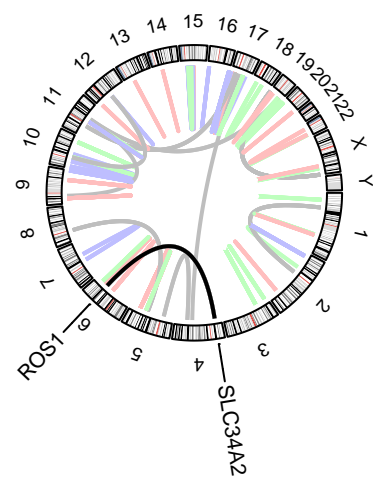
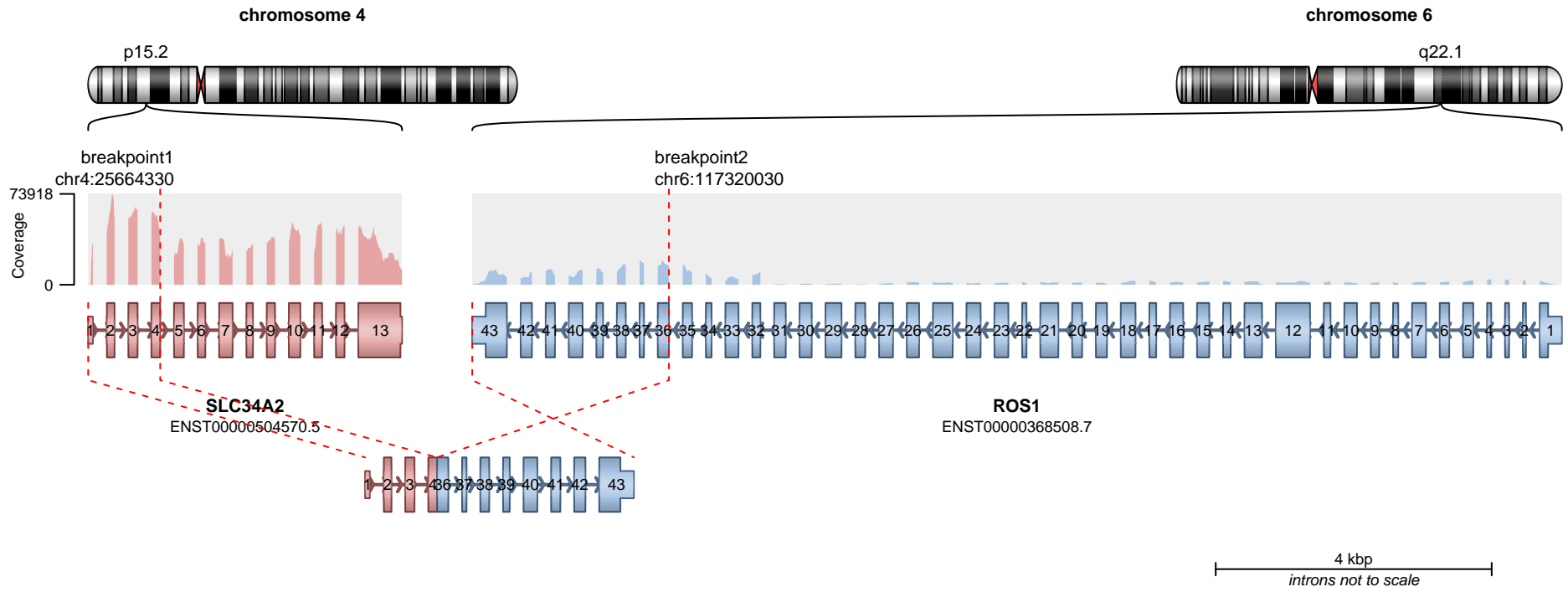

SUPPORTING READ COUNT

Split reads = 5

Discordant mates = 0

— translocation — deletion
— duplication — inversion

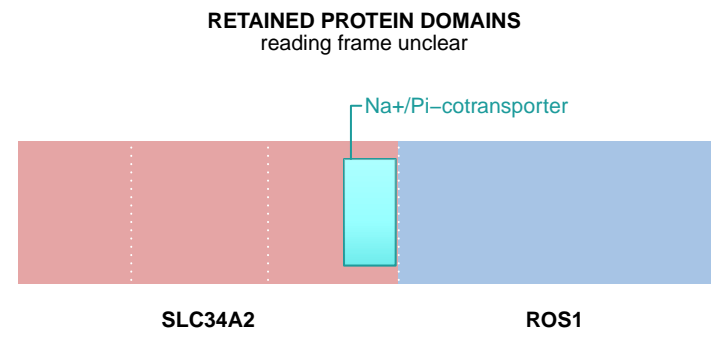
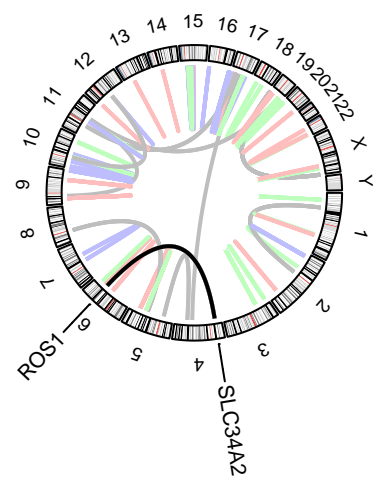
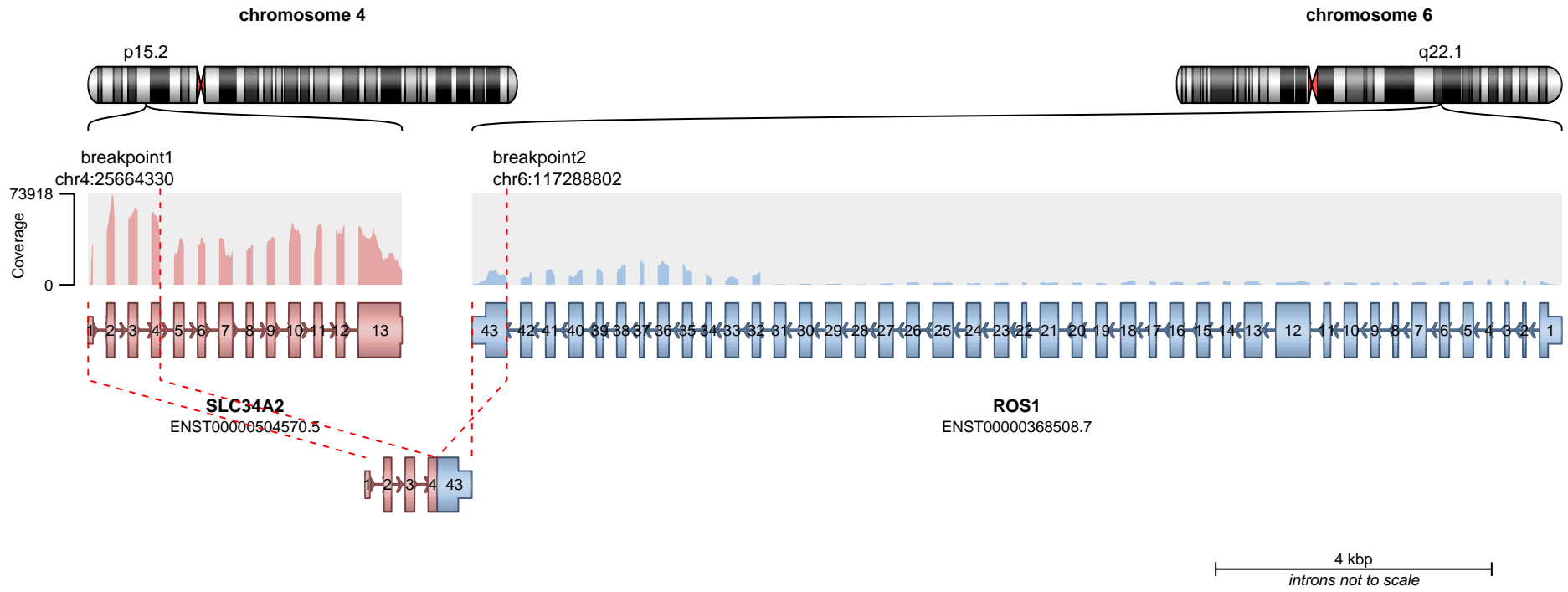

SUPPORTING READ COUNT

Split reads = 4
Discordant mates = 0

— translocation — deletion
— duplication — inversion

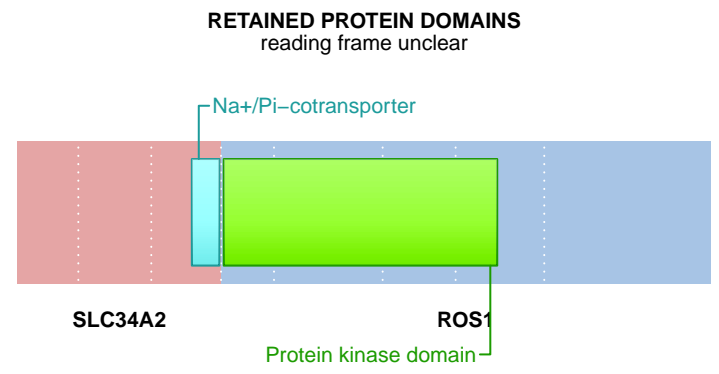
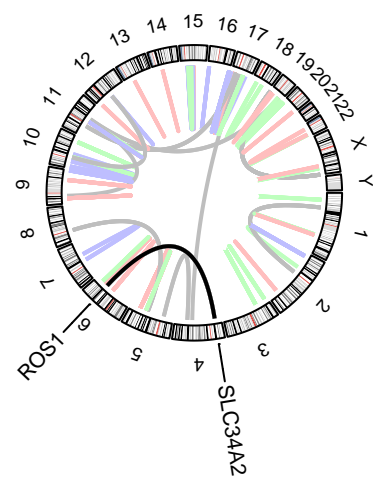
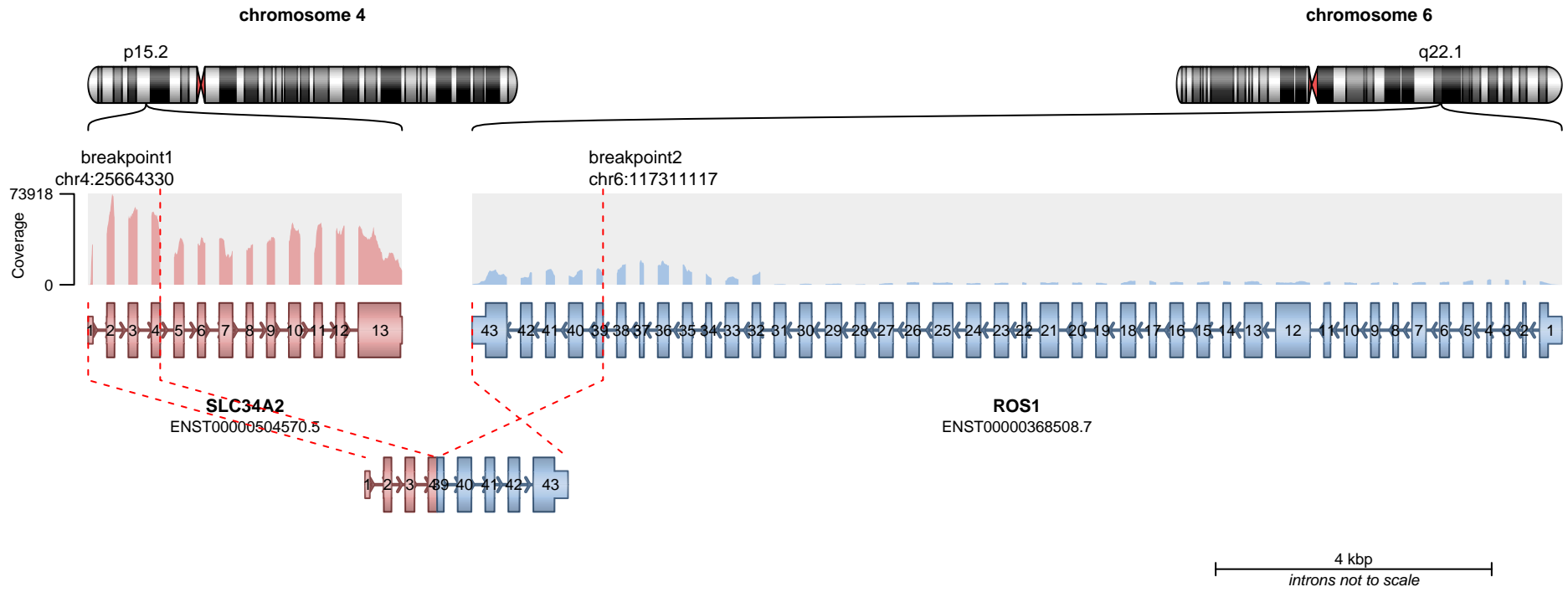

SUPPORTING READ COUNT

Split reads = 1
Discordant mates = 0

- translocation
- duplication
- deletion
- inversion

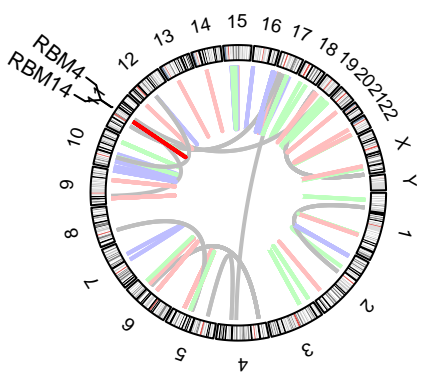
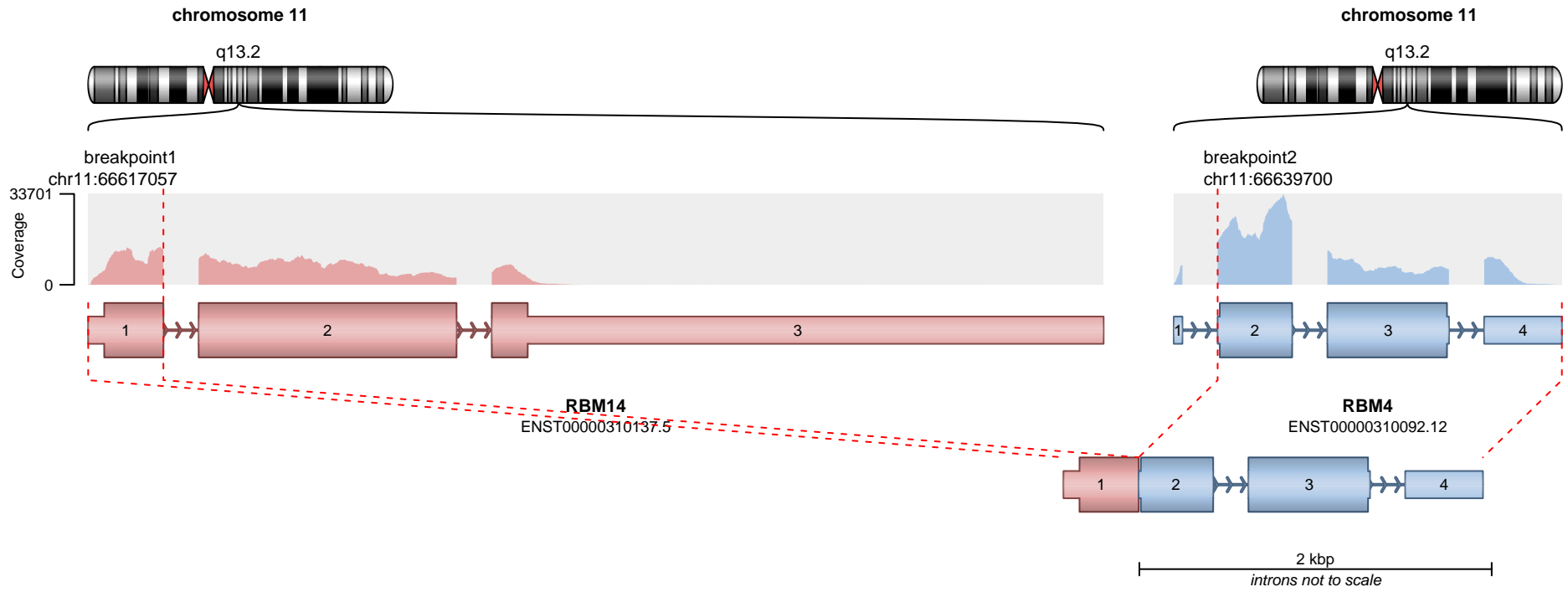

RETAINED PROTEIN DOMAINS
reading frame unclear

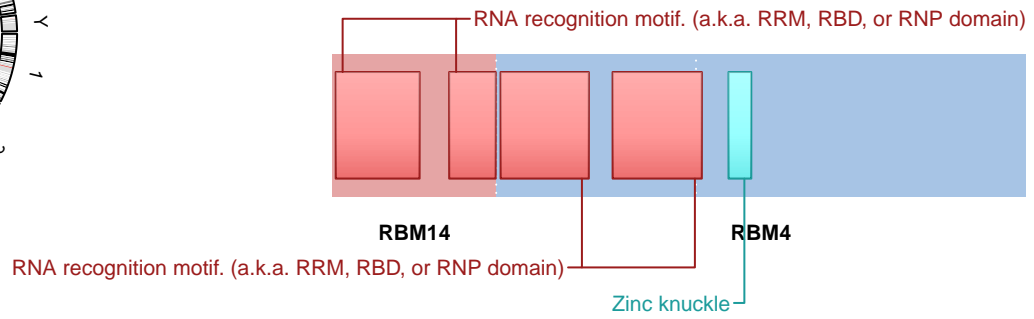

SUPPORTING READ COUNT

Split reads = 1339
Discordant mates = 37

- translocation
- duplication
- deletion
- inversion

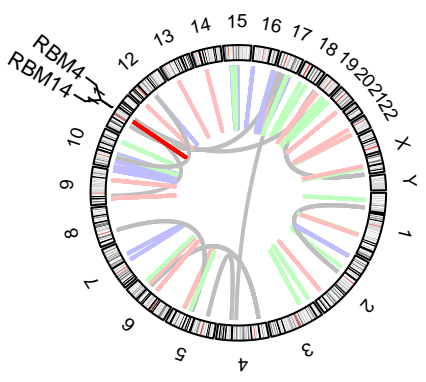
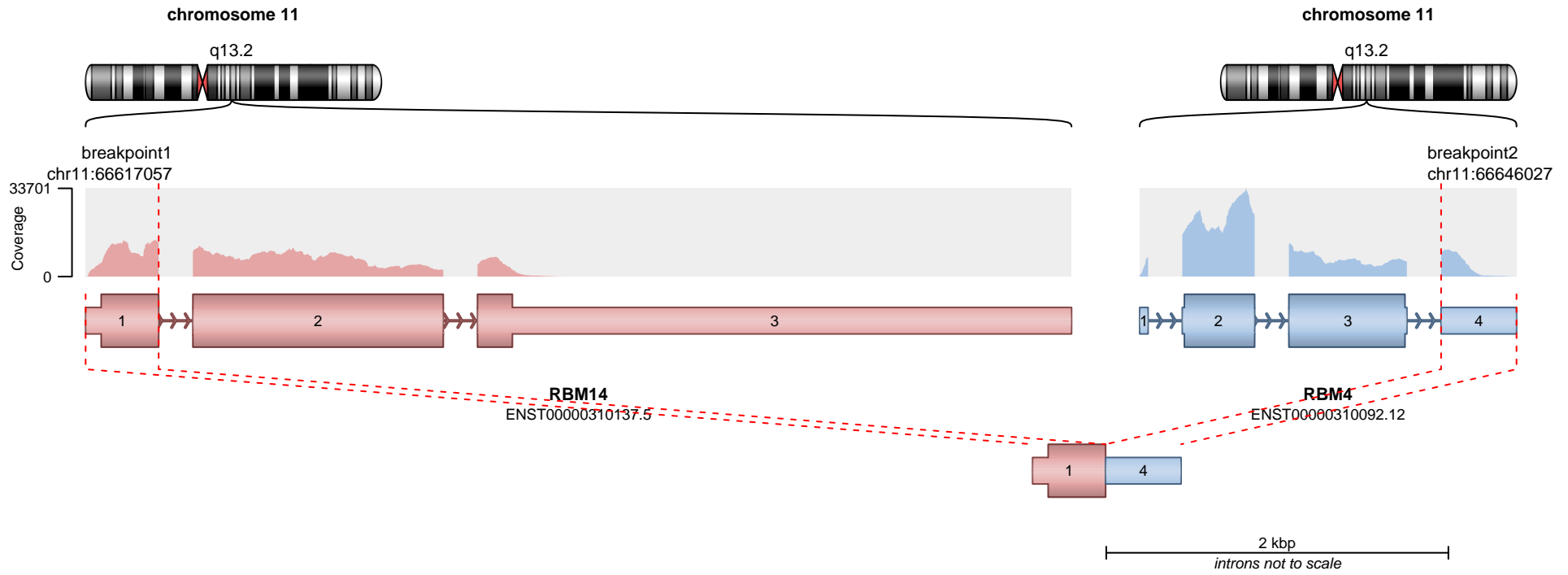

RETAINED PROTEIN DOMAINS
reading frame unclear

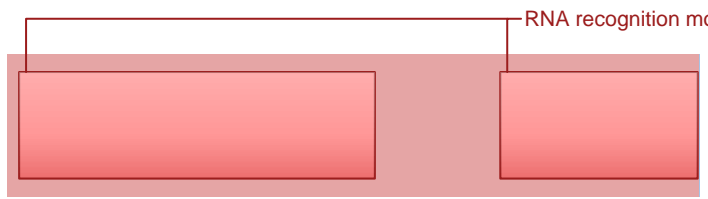

SUPPORTING READ COUNT

Split reads = 73
Discordant mates = 2

- translocation
- duplication
- deletion
- inversion

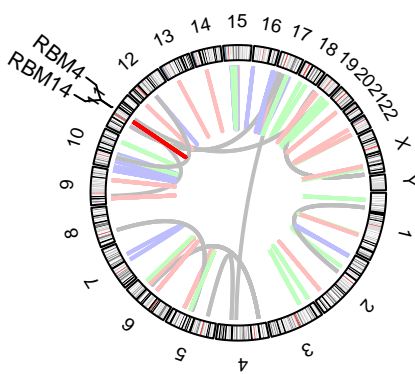
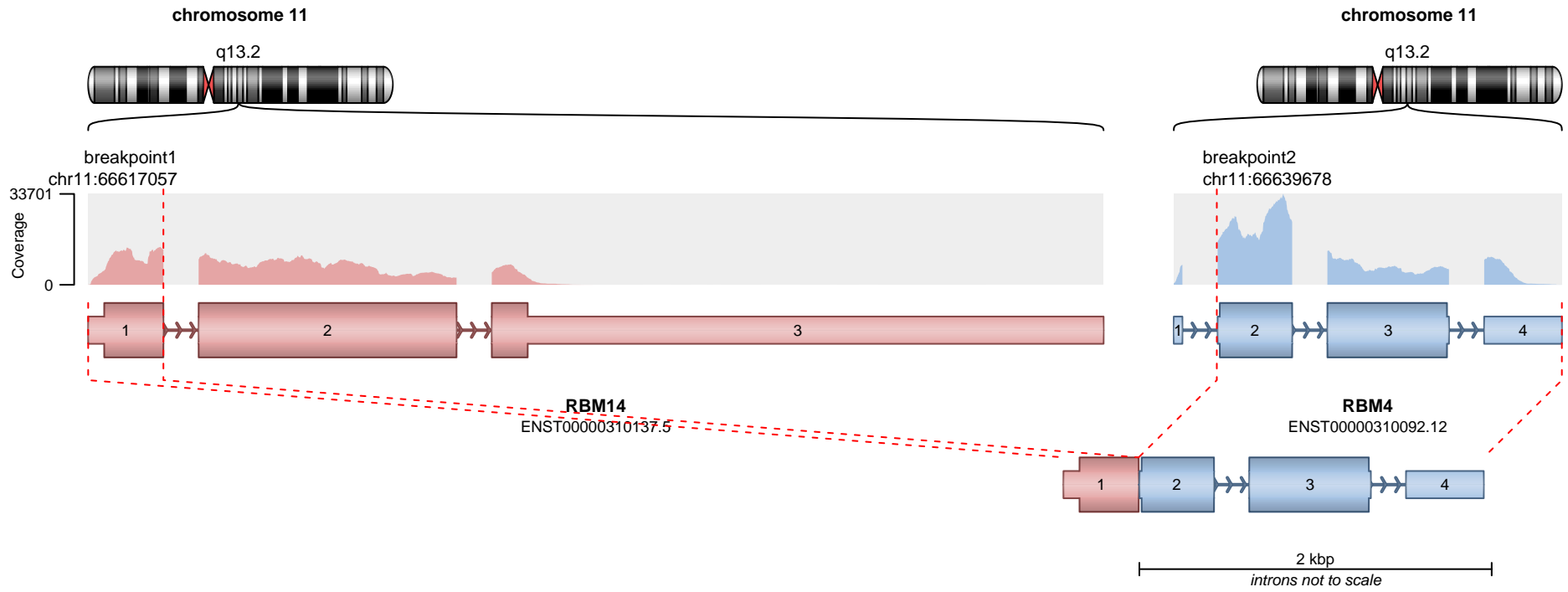

RETAINED PROTEIN DOMAINS
reading frame unclear

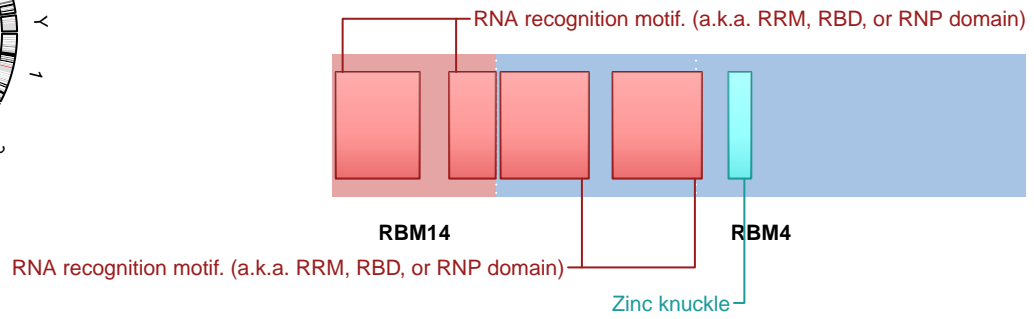

SUPPORTING READ COUNT

Split reads = 29
Discordant mates = 38

- translocation
- duplication
- deletion
- inversion

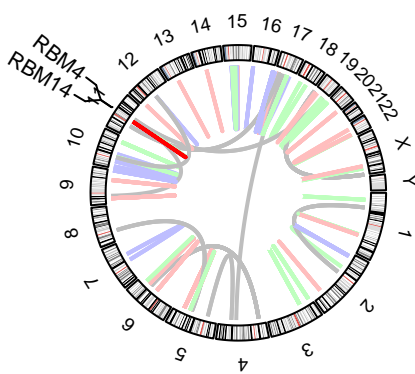
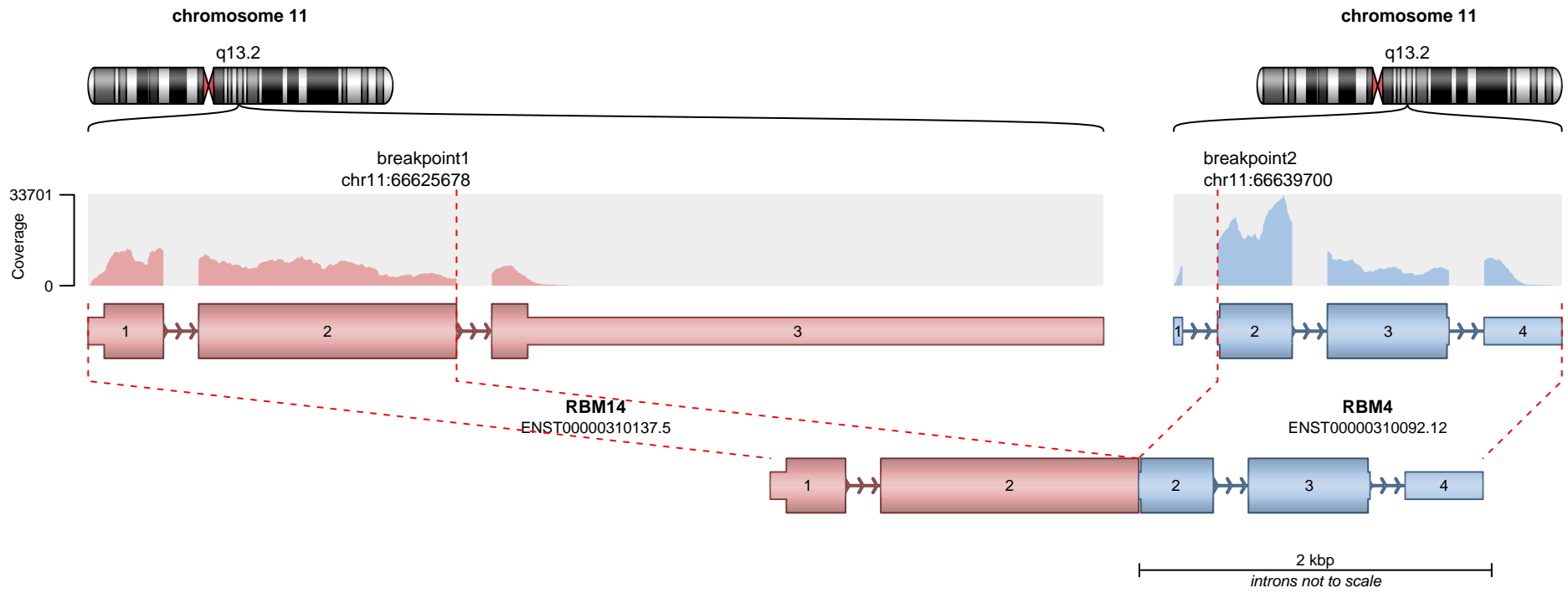

RETAINED PROTEIN DOMAINS
reading frame unclear

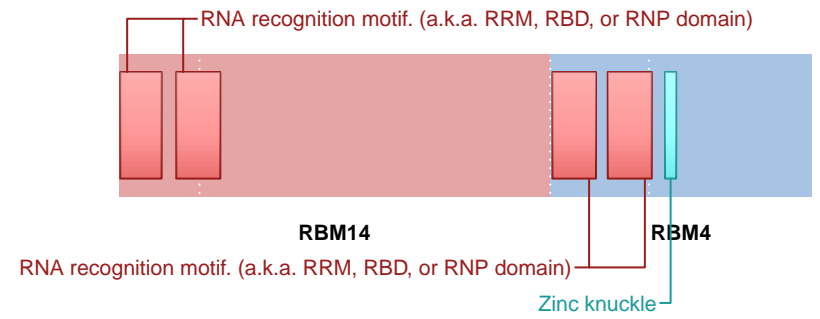

SUPPORTING READ COUNT

Split reads = 6
Discordant mates = 37

- translocation
- duplication
- deletion
- inversion

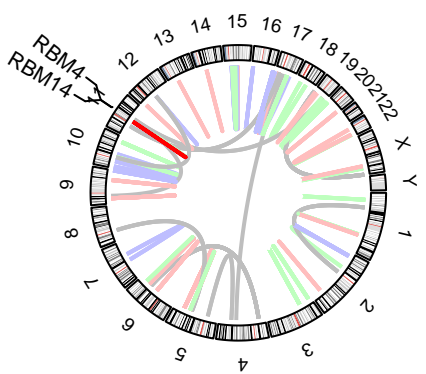
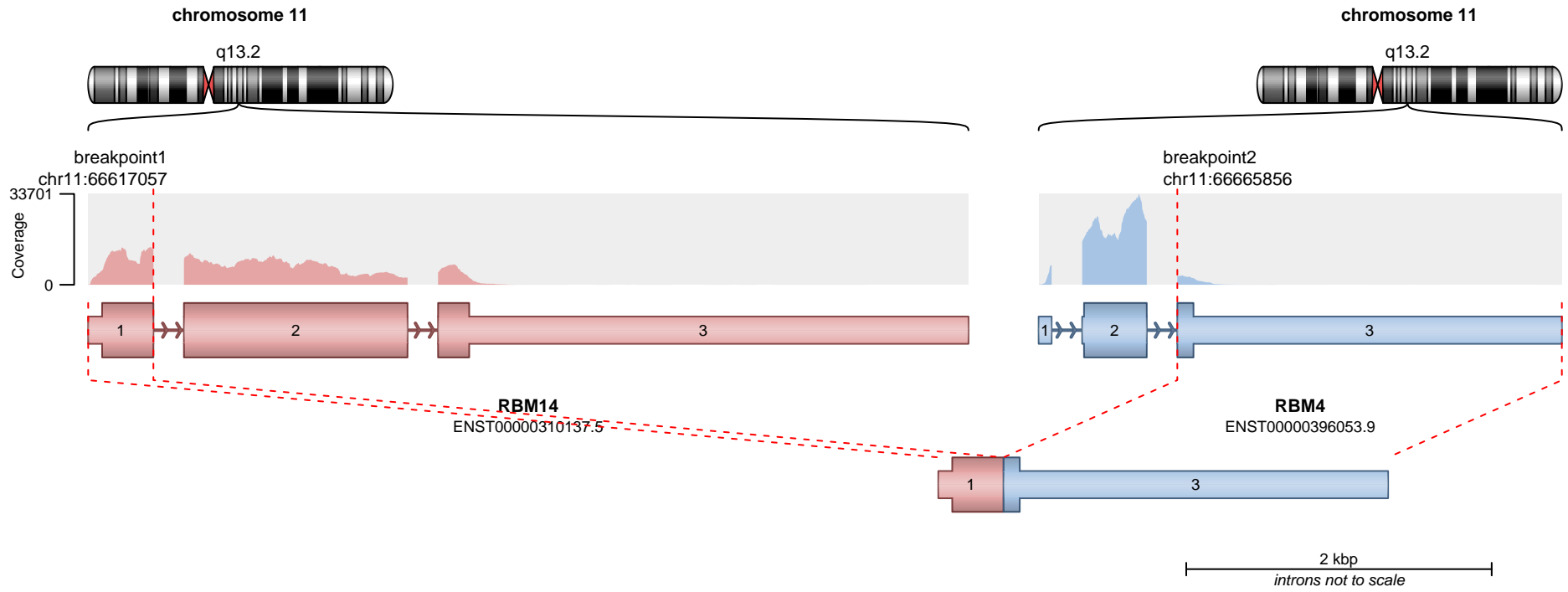

RETAINED PROTEIN DOMAINS
reading frame unclear

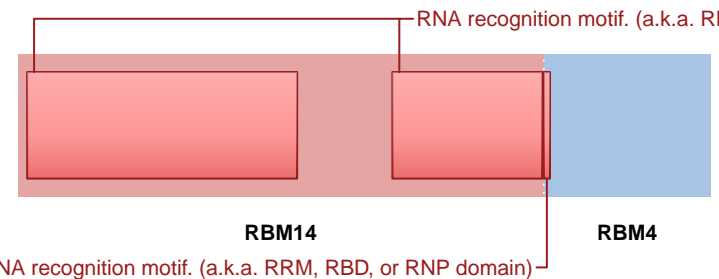

SUPPORTING READ COUNT

Split reads = 15
Discordant mates = 0

- translocation
- duplication
- deletion
- inversion

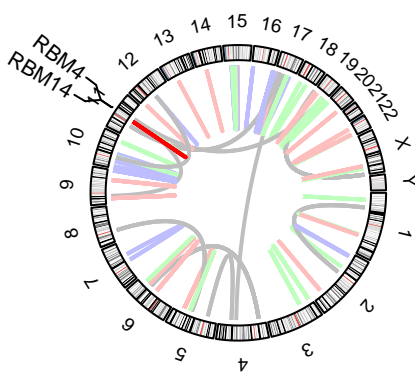
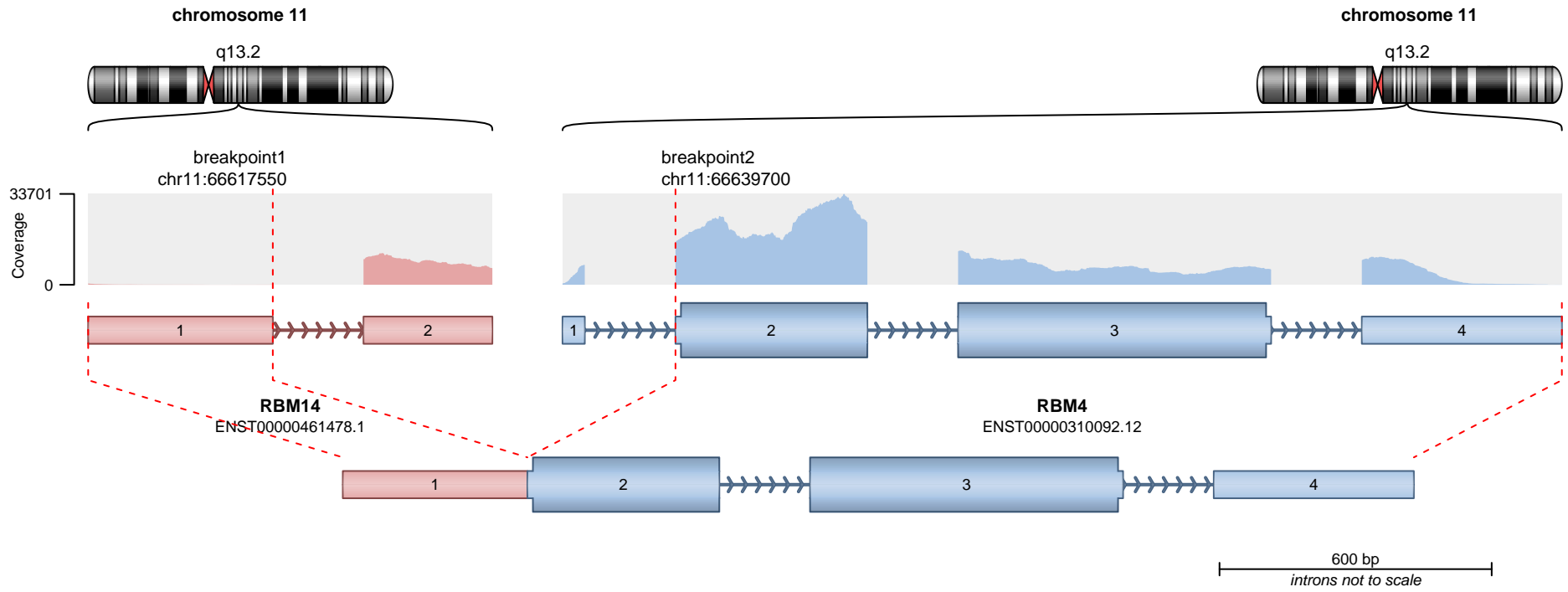

RNA recognition motif. (a.k.a. RRM, RBD, or RNP domain)

RETAINED PROTEIN DOMAINS
reading frame unclear

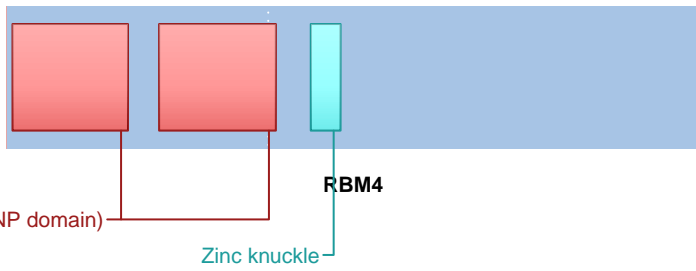

SUPPORTING READ COUNT

Split reads = 4
Discordant mates = 37

- translocation — deletion
- duplication — inversion

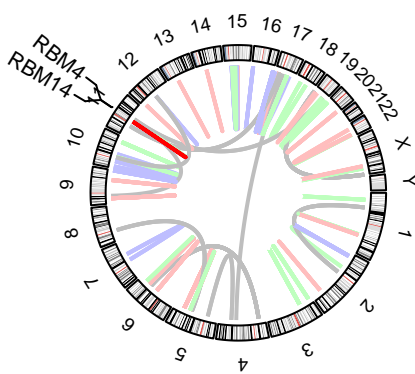
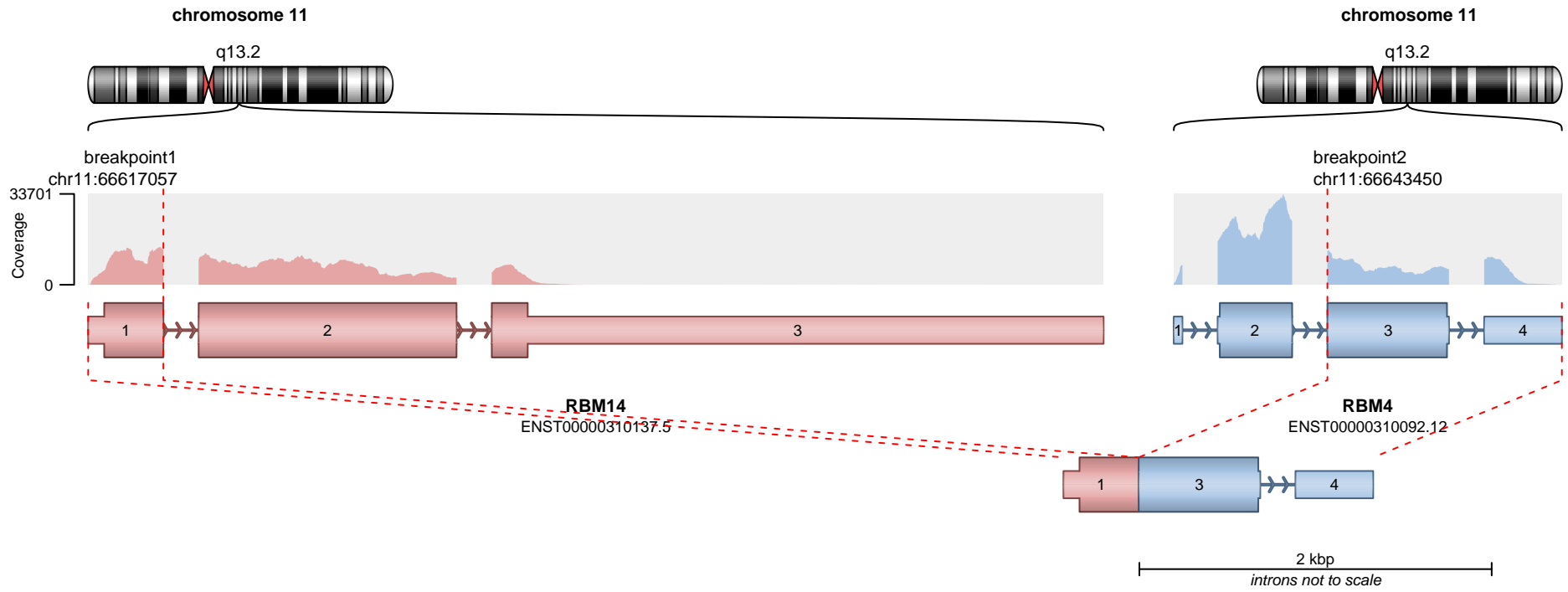

RETAINED PROTEIN DOMAINS
reading frame unclear

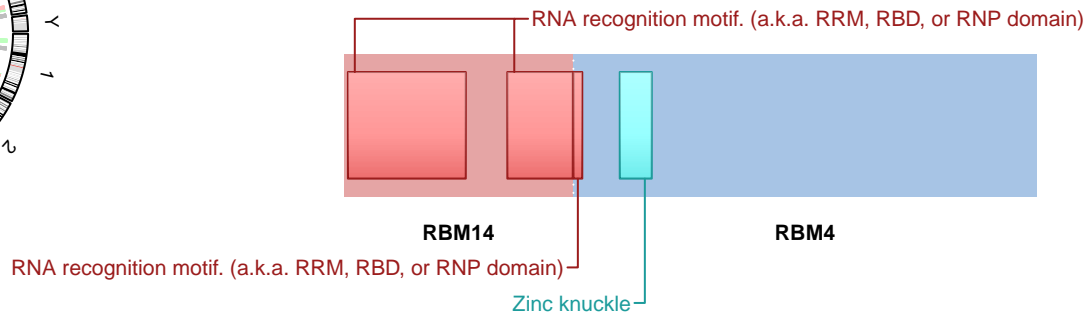

SUPPORTING READ COUNT

Split reads = 12
Discordant mates = 2

- translocation
- duplication
- deletion
- inversion

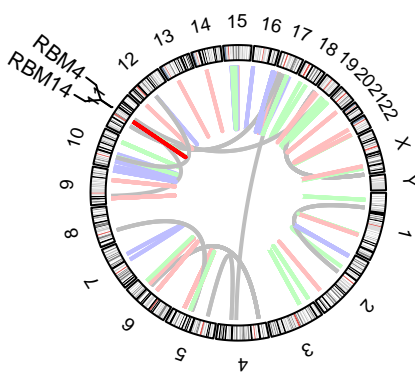
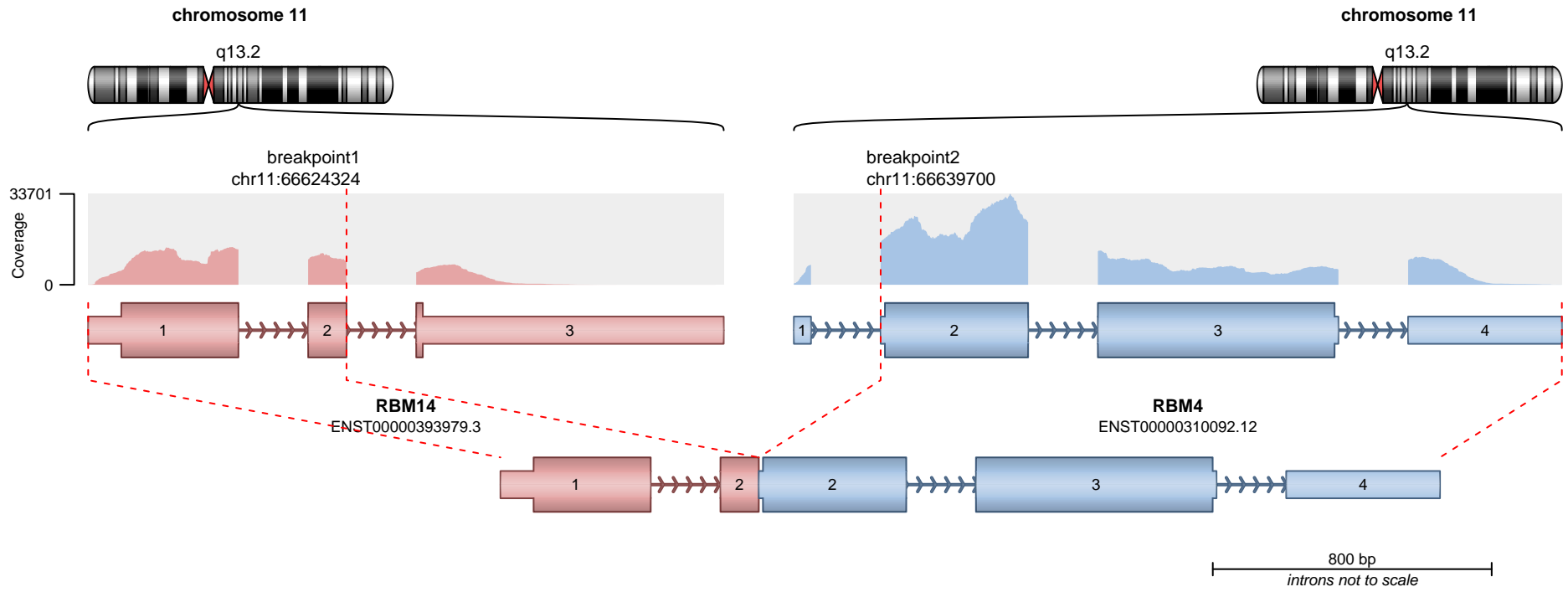

RETAINED PROTEIN DOMAINS
reading frame unclear

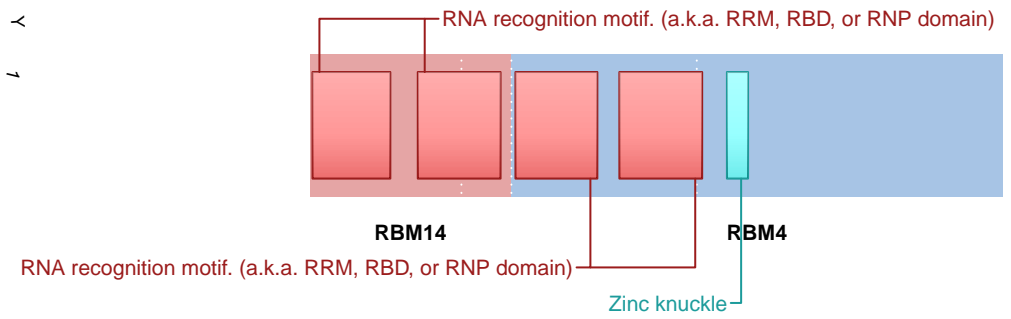

SUPPORTING READ COUNT

Split reads = 1
Discordant mates = 37

- translocation
- duplication
- deletion
- inversion

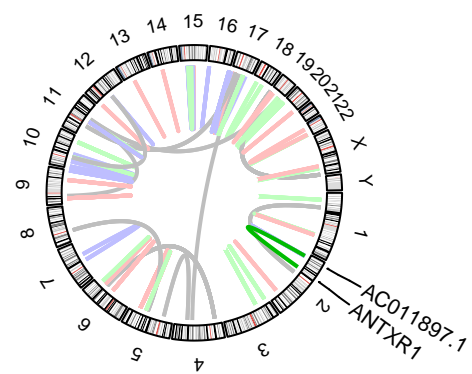
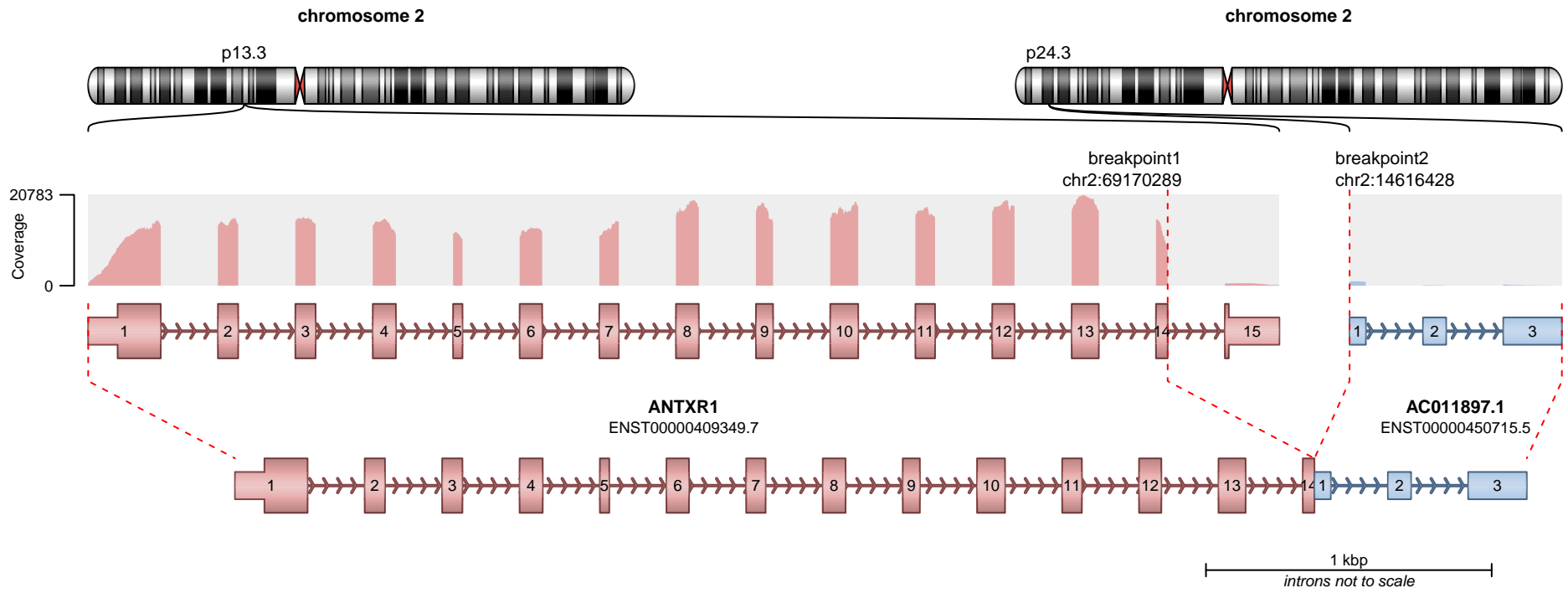

RETAINED PROTEIN DOMAINS
reading frame unclear

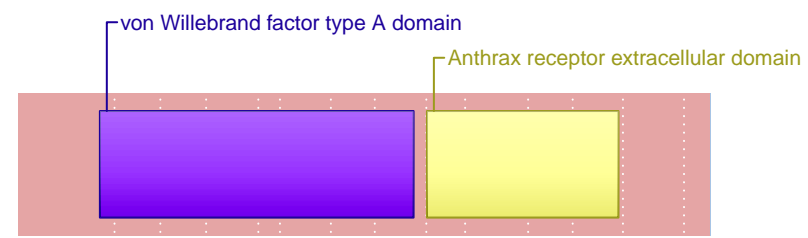

SUPPORTING READ COUNT

Split reads = 814
Discordant mates = 27

- translocation
- duplication
- deletion
- inversion

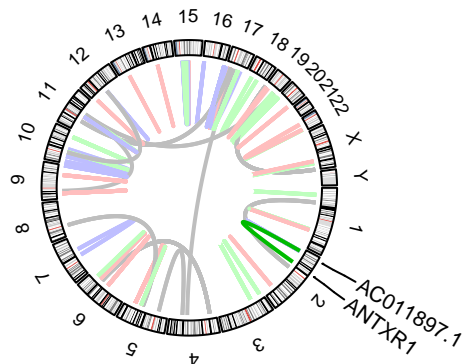
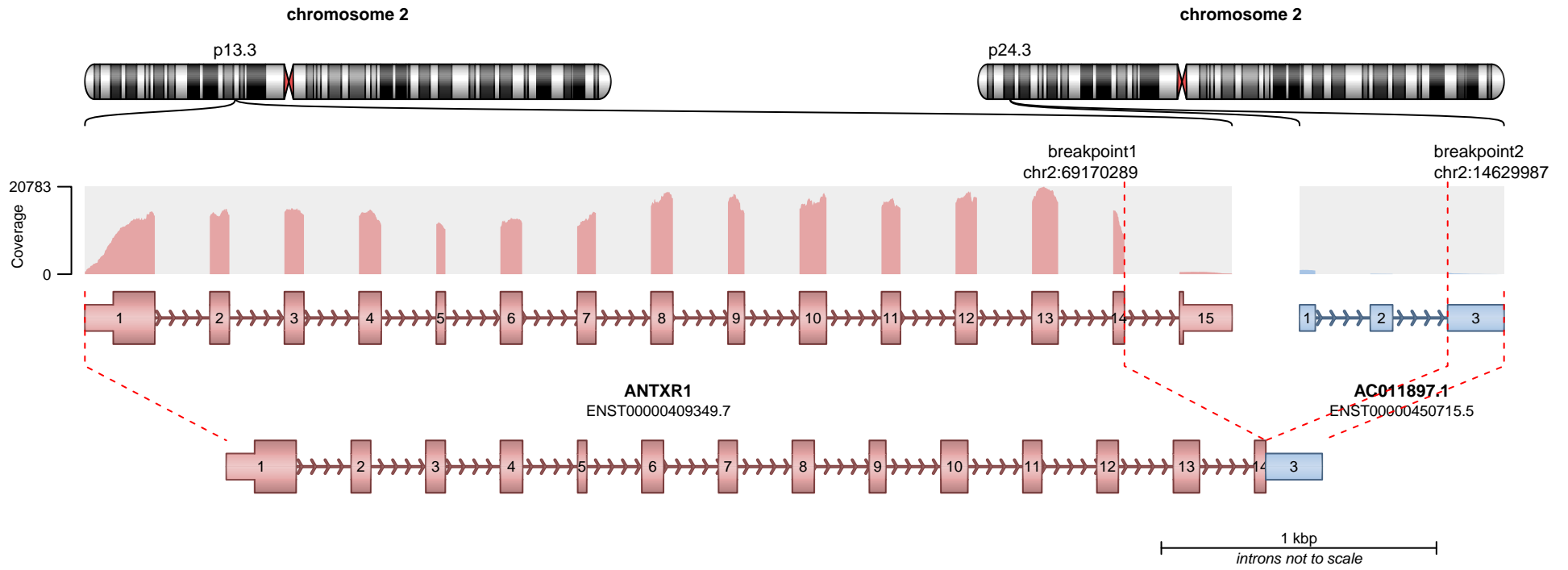

RETAINED PROTEIN DOMAINS
reading frame unclear

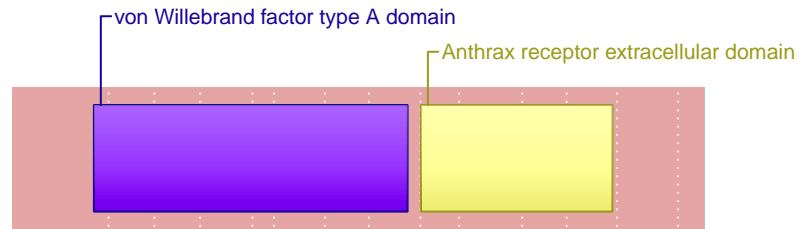

ANTXR1

SUPPORTING READ COUNT

Split reads = 4
Discordant mates = 10

— translocation — deletion
— duplication — inversion

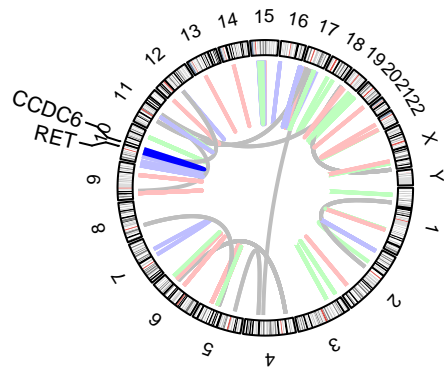
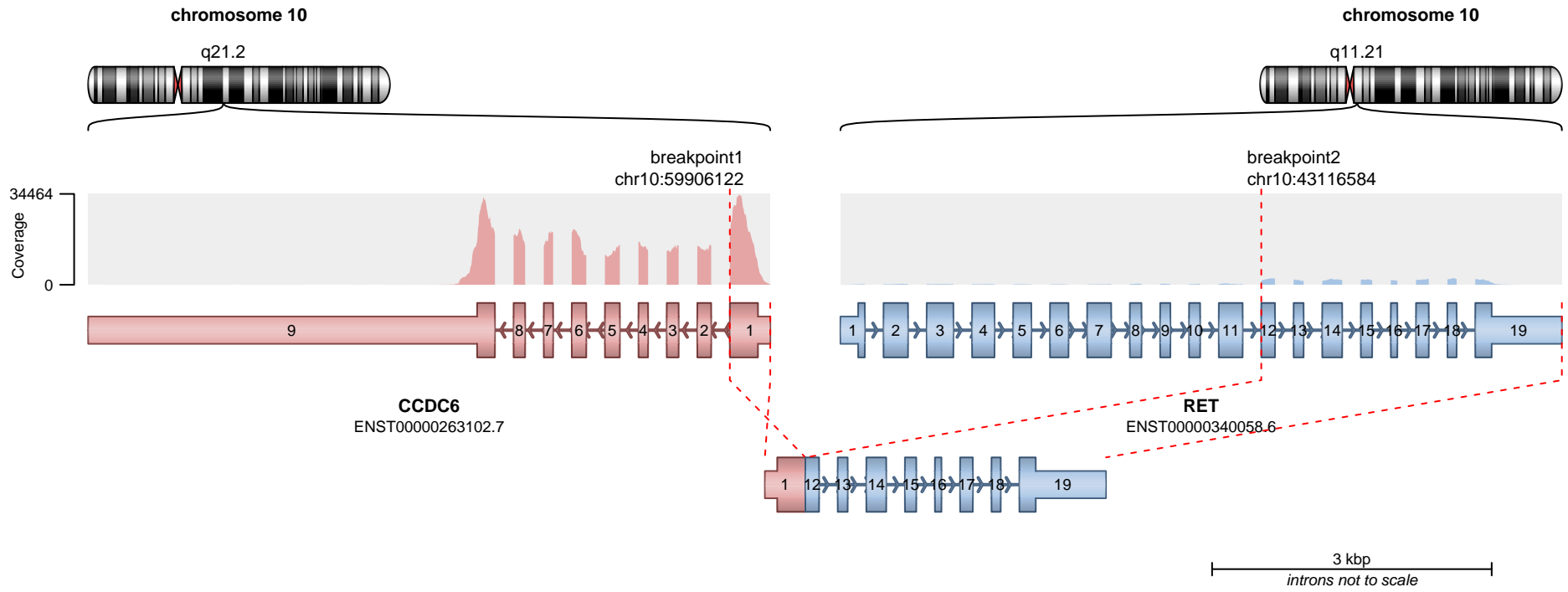

RETAINED PROTEIN DOMAINS
reading frame unclear

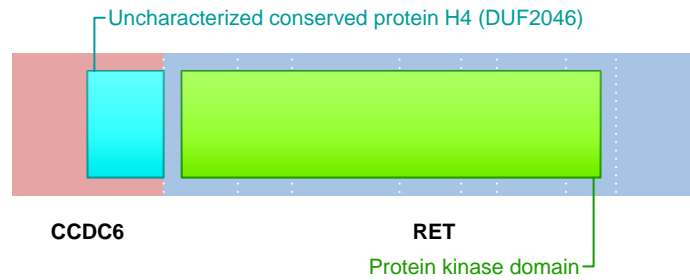

SUPPORTING READ COUNT

Split reads = 504
Discordant mates = 30

— translocation — deletion
— duplication — inversion

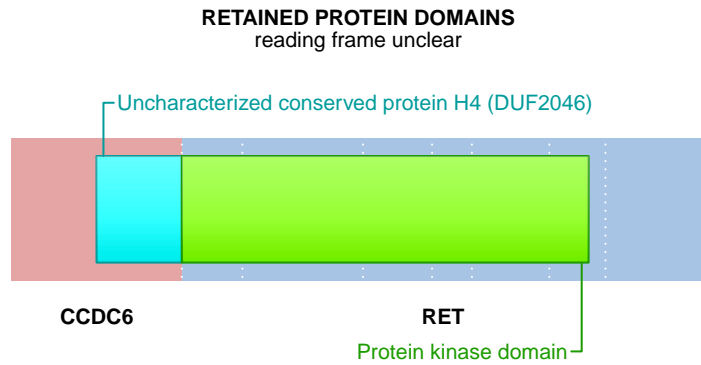
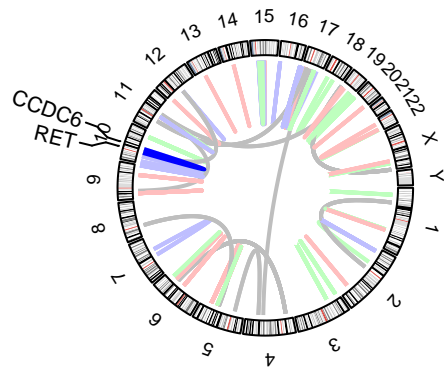
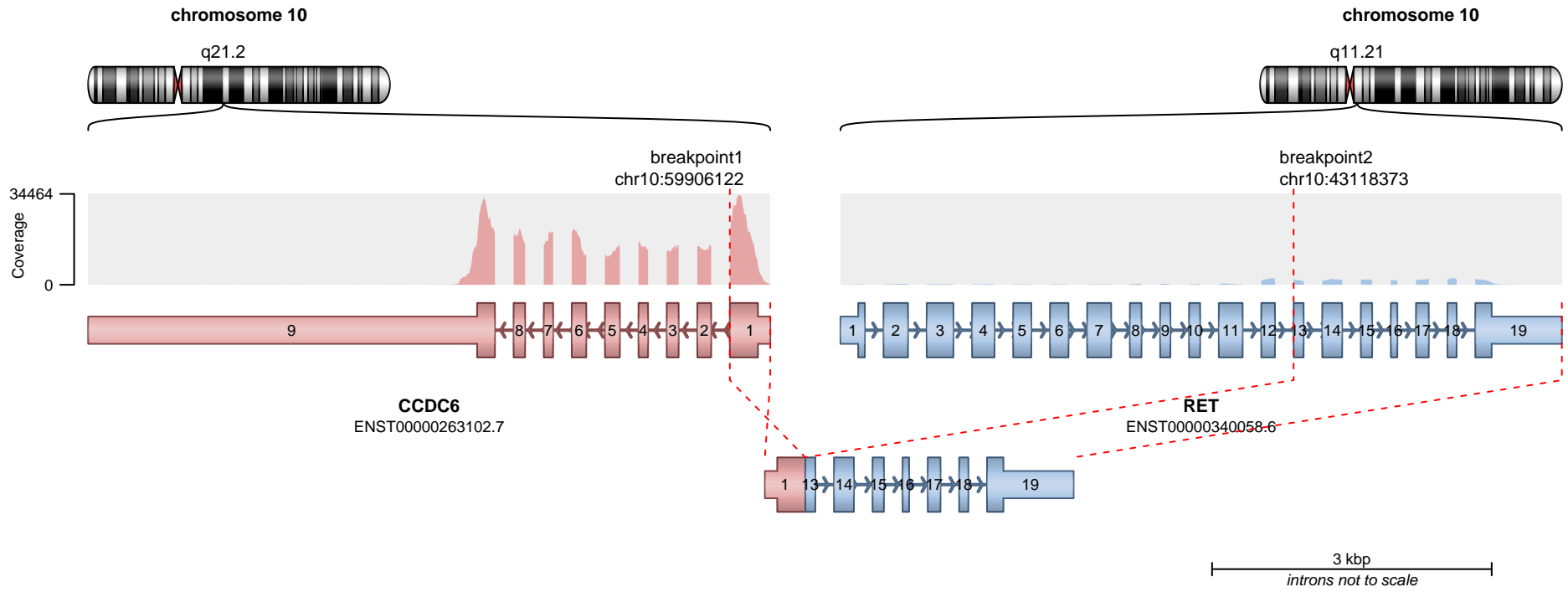

SUPPORTING READ COUNT

Split reads = 1
Discordant mates = 0

- translocation
- duplication
- deletion
- inversion

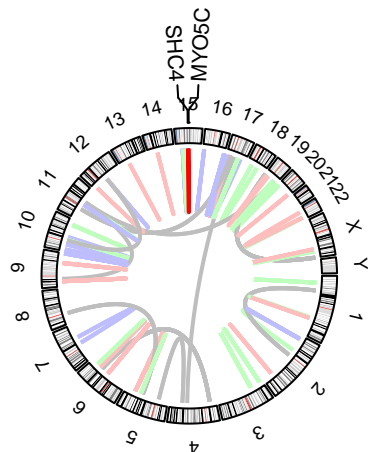
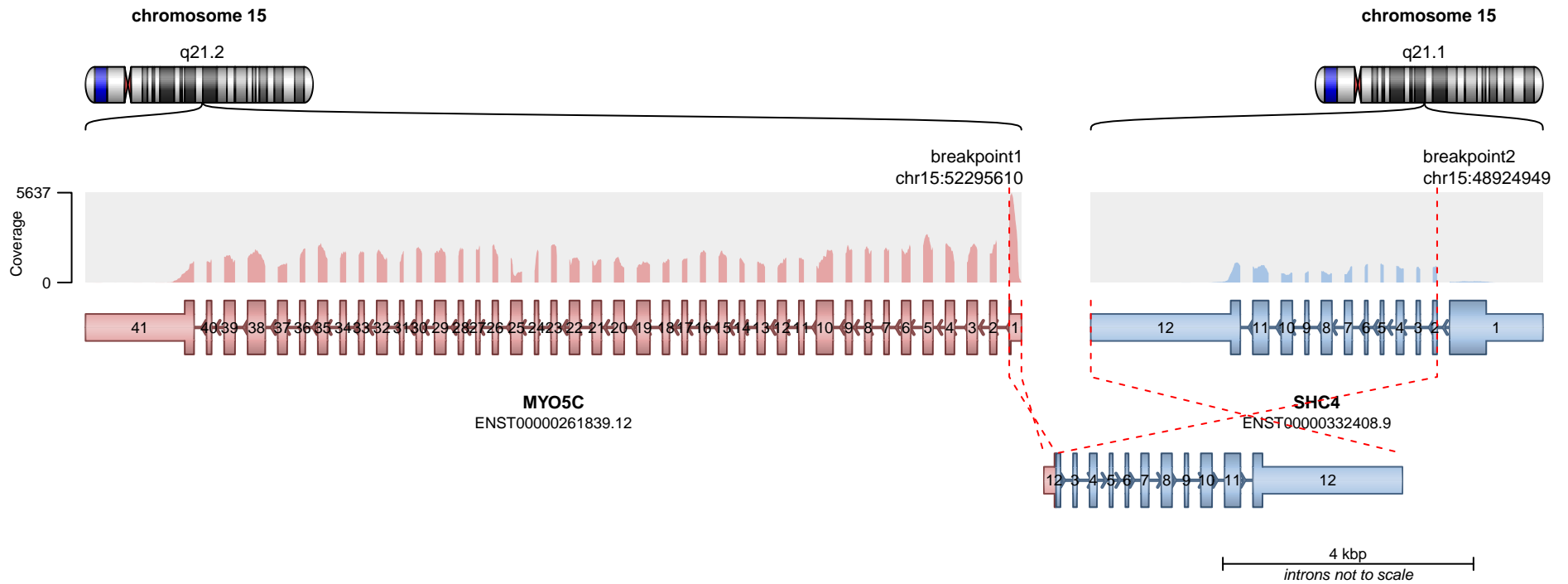

RETAINED PROTEIN DOMAINS
reading frame unclear

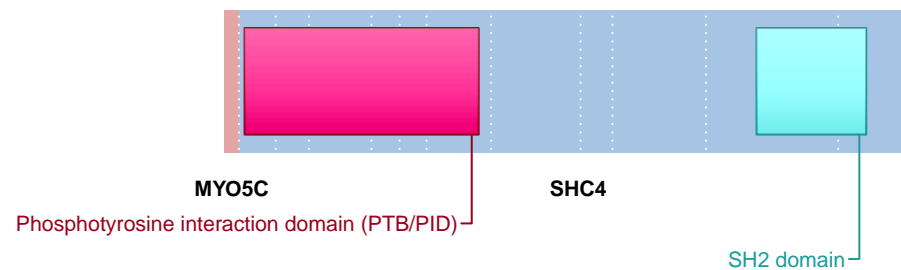

SUPPORTING READ COUNT

Split reads = 484
Discordant mates = 20

— translocation — deletion
— duplication — inversion

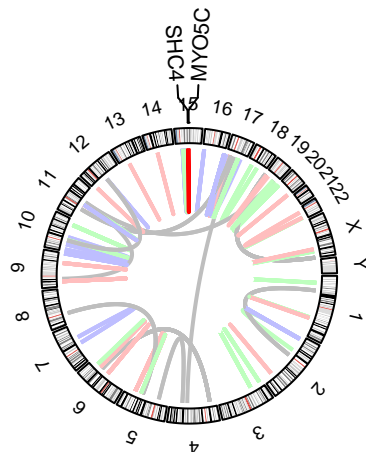
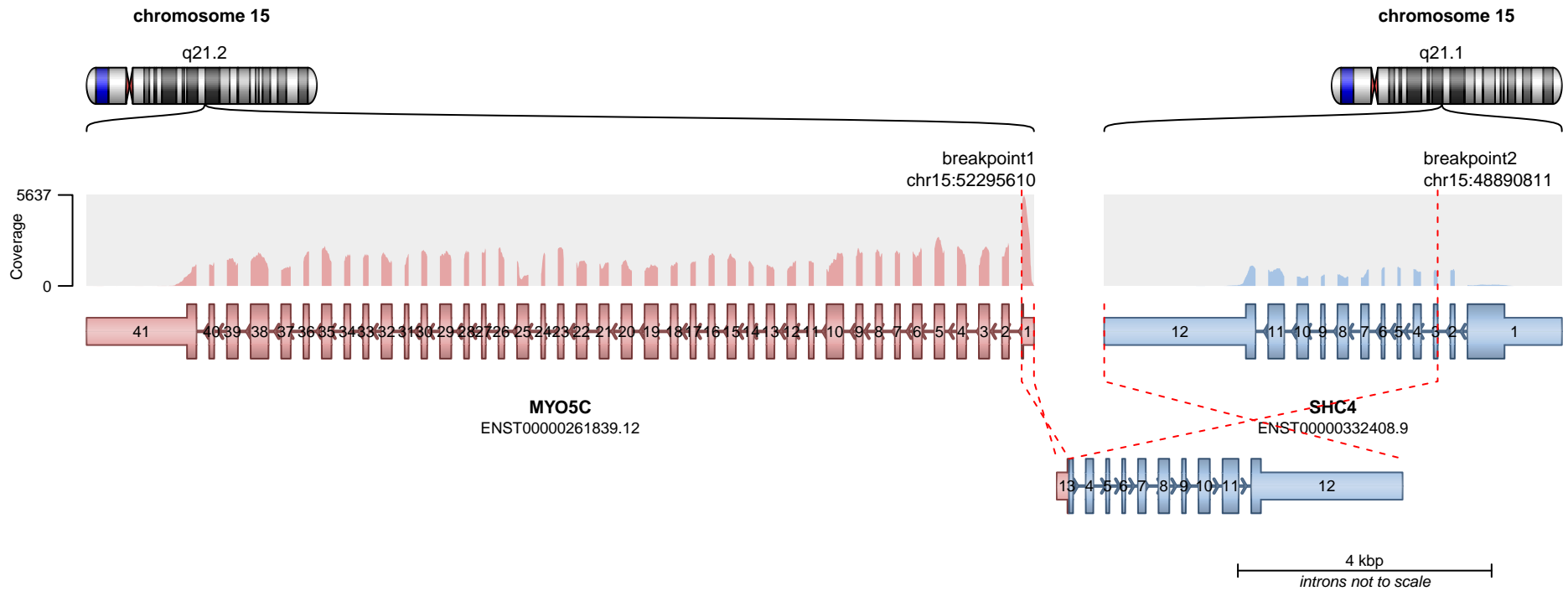

RETAINED PROTEIN DOMAINS
reading frame unclear

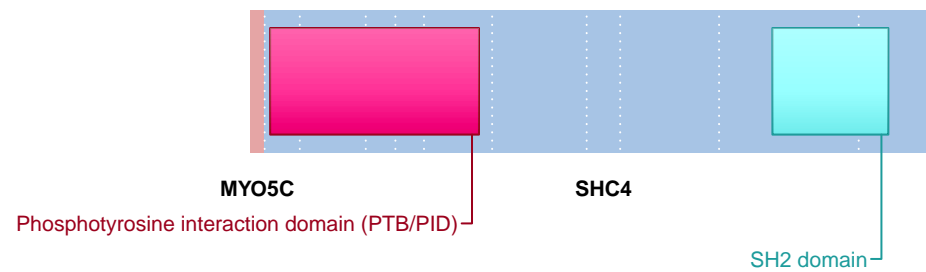

SUPPORTING READ COUNT

Split reads = 6
Discordant mates = 9

- translocation
- duplication
- deletion
- inversion

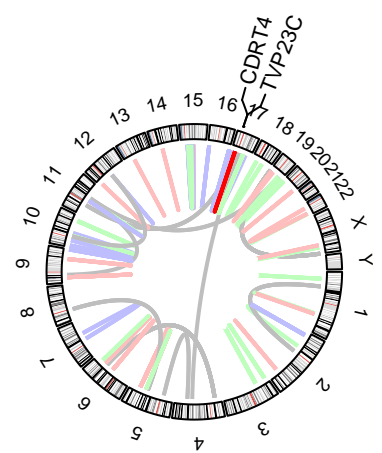
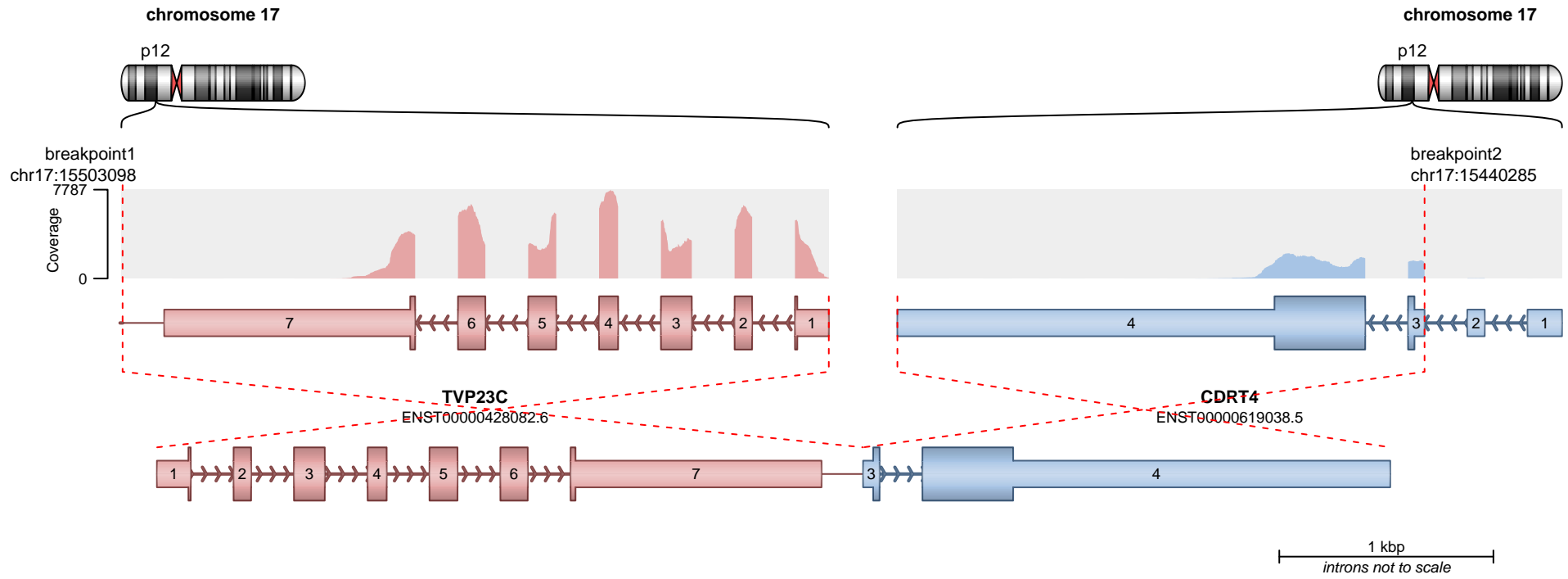

RETAINED PROTEIN DOMAINS
reading frame unclear

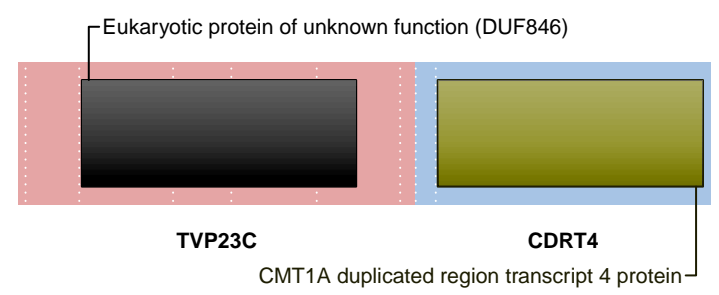

SUPPORTING READ COUNT

Split reads = 299
Discordant mates = 16

- translocation
- duplication
- deletion
- inversion

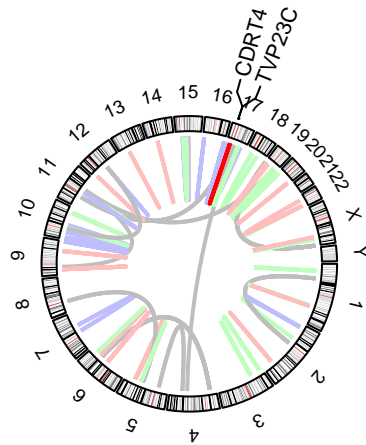
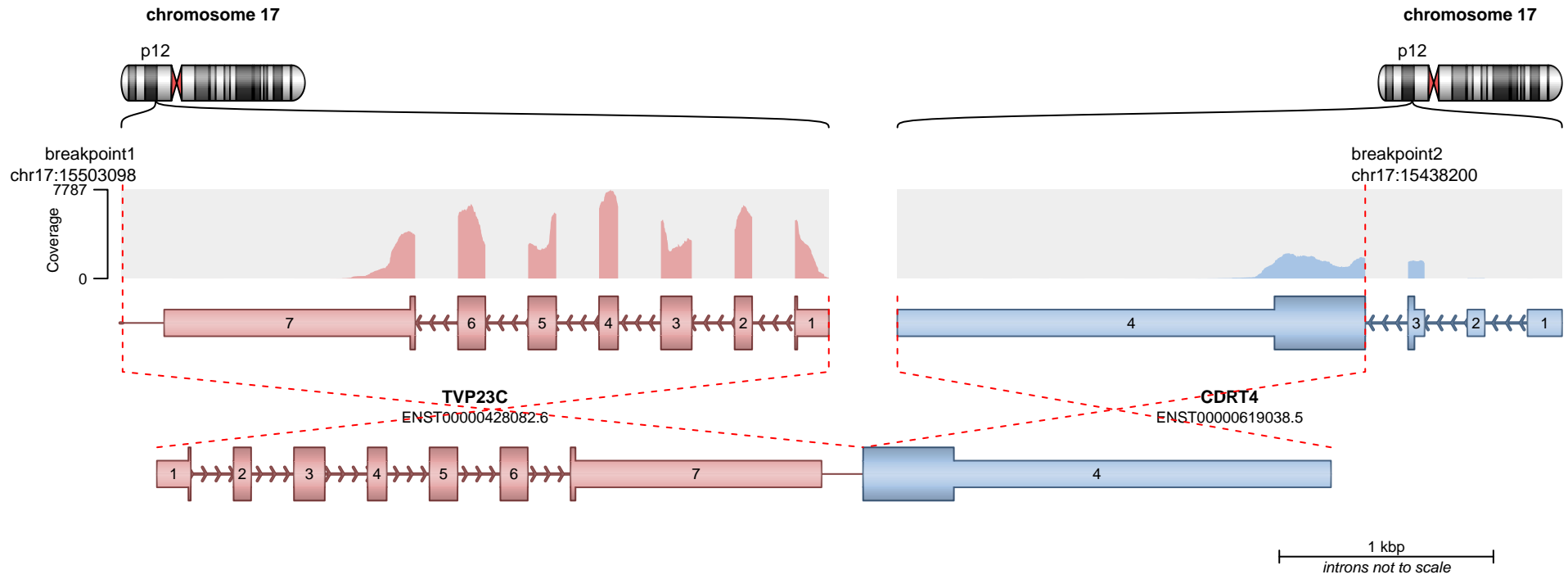

RETAINED PROTEIN DOMAINS
reading frame unclear

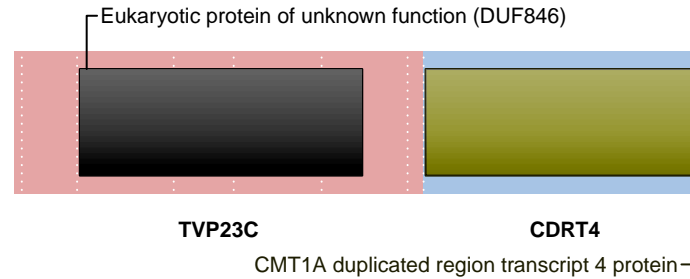

SUPPORTING READ COUNT

Split reads = 73
Discordant mates = 3

— translocation — deletion
— duplication — inversion

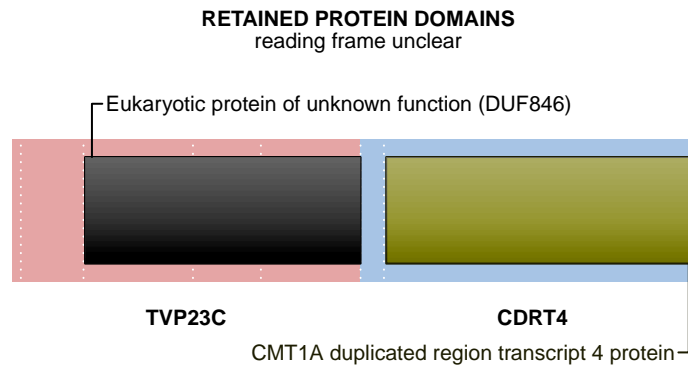
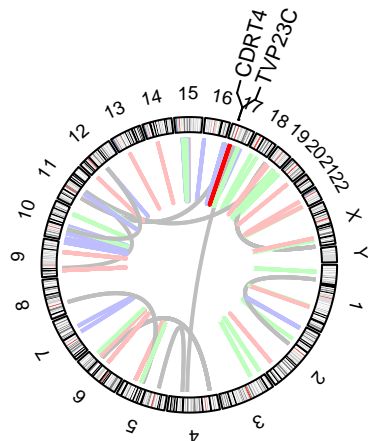
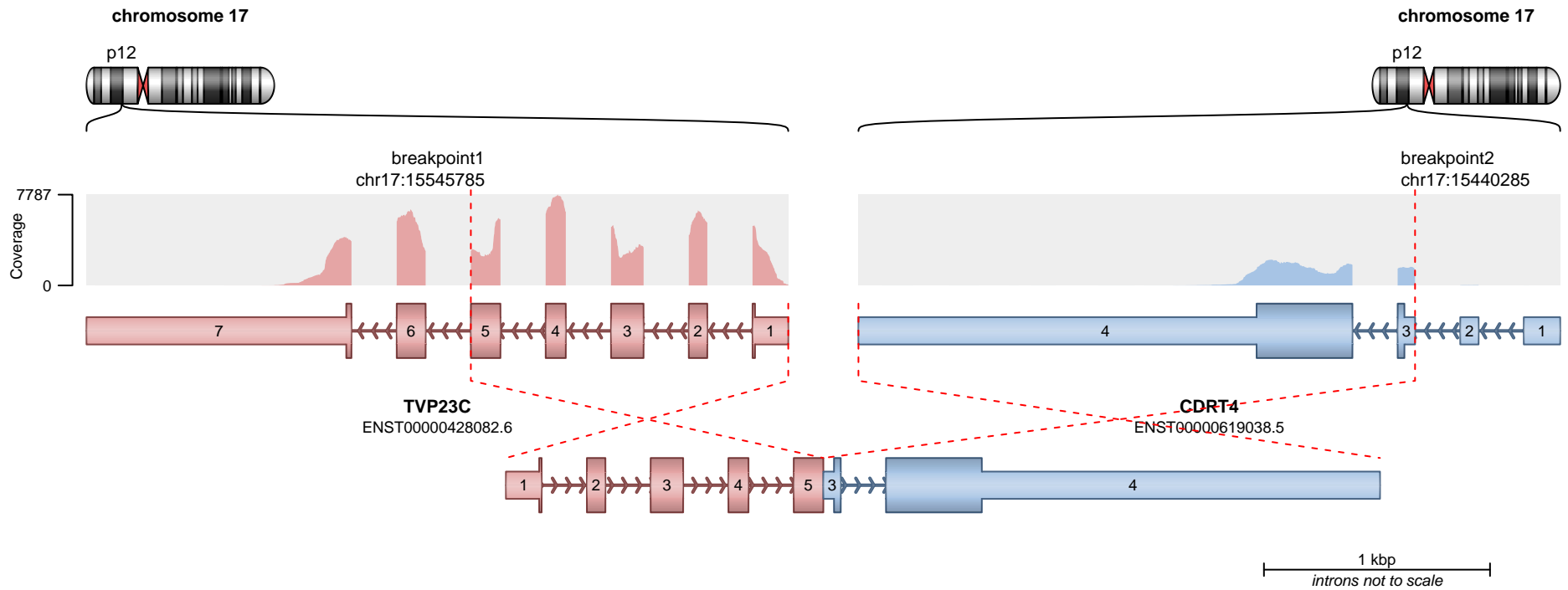

SUPPORTING READ COUNT

Split reads = 62
Discordant mates = 2

— translocation — deletion
— duplication — inversion

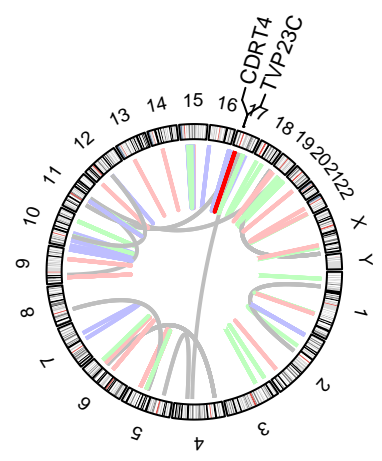
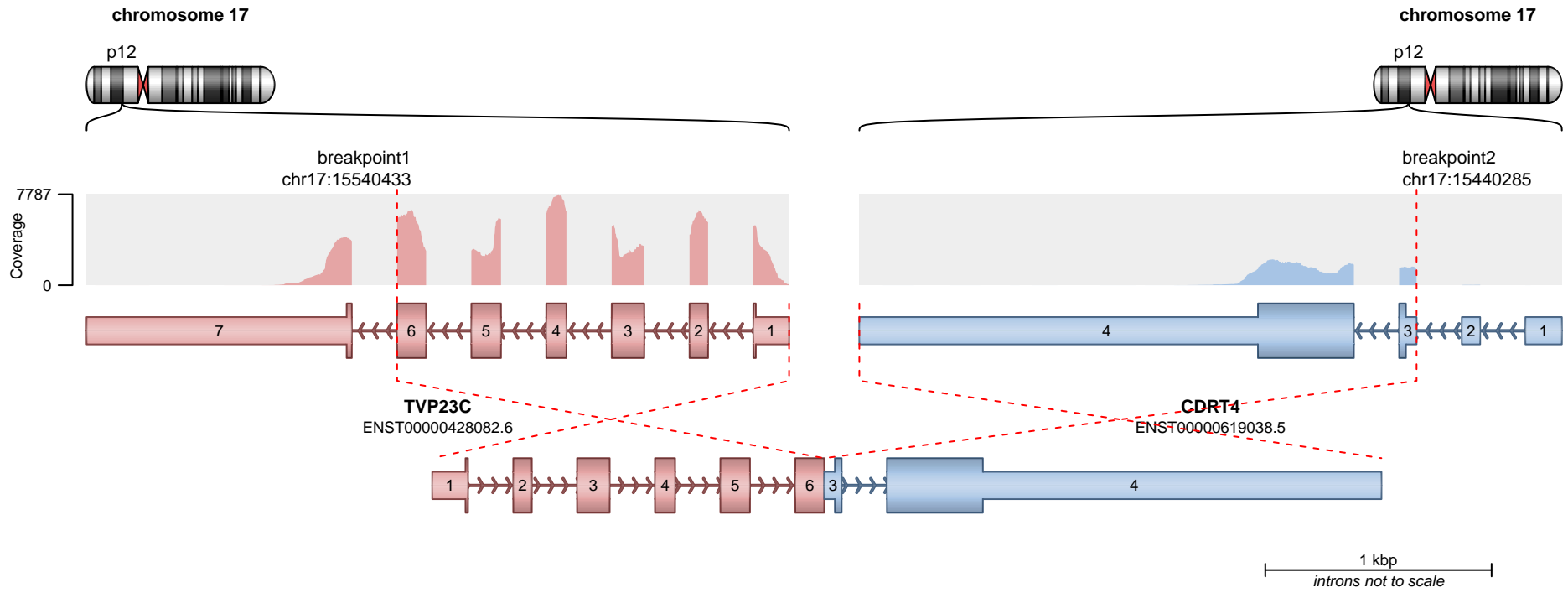

RETAINED PROTEIN DOMAINS
reading frame unclear

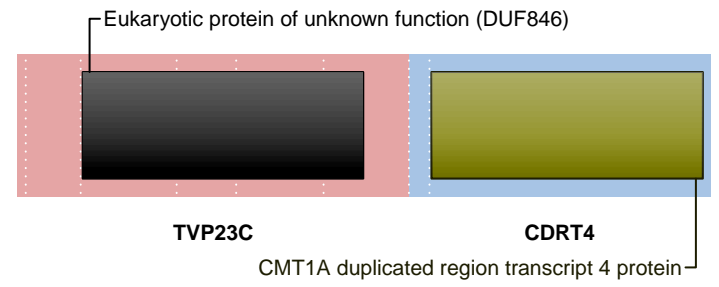

SUPPORTING READ COUNT

Split reads = 58
Discordant mates = 4

- translocation
- duplication
- deletion
- inversion

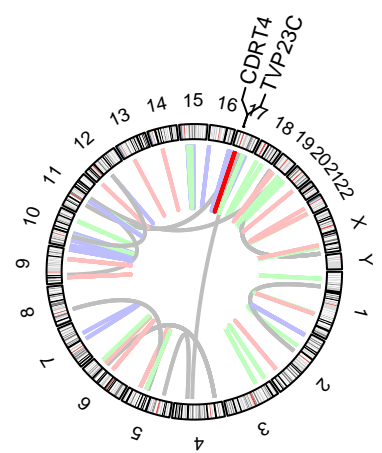
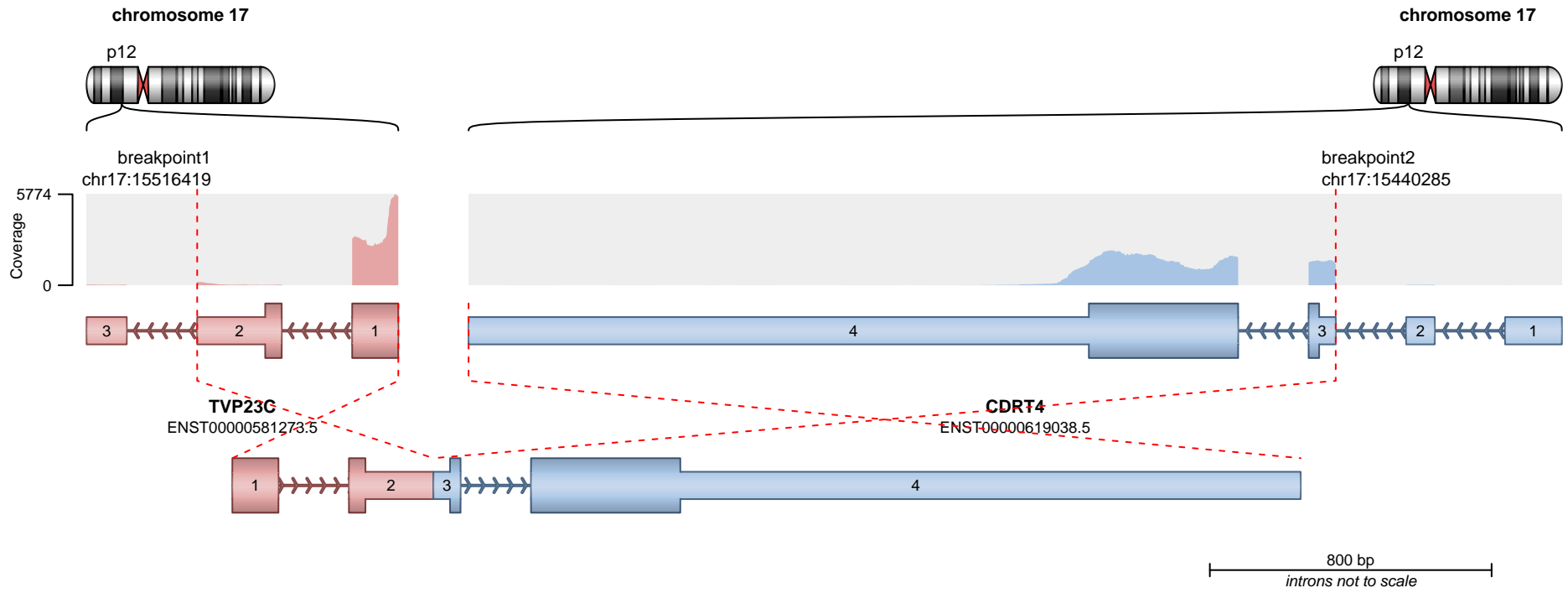

RETAINED PROTEIN DOMAINS
reading frame unclear

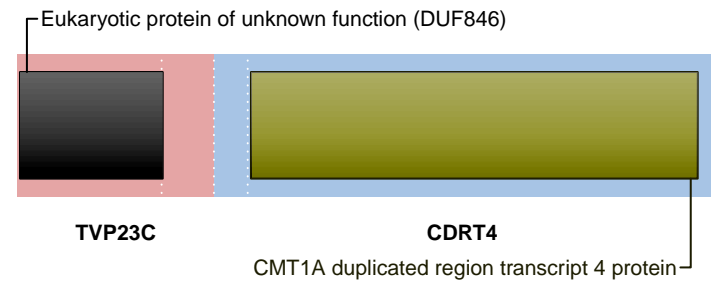

SUPPORTING READ COUNT

Split reads = 29
Discordant mates = 4

- translocation
- duplication
- deletion
- inversion

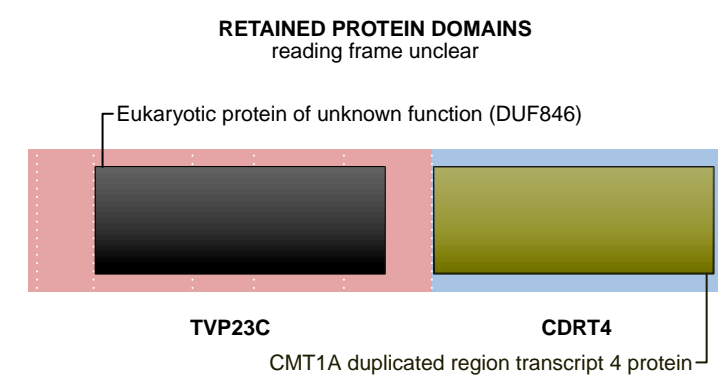
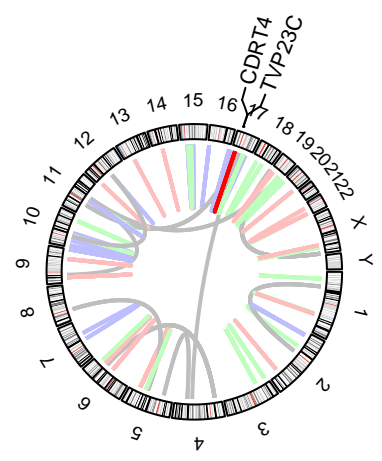
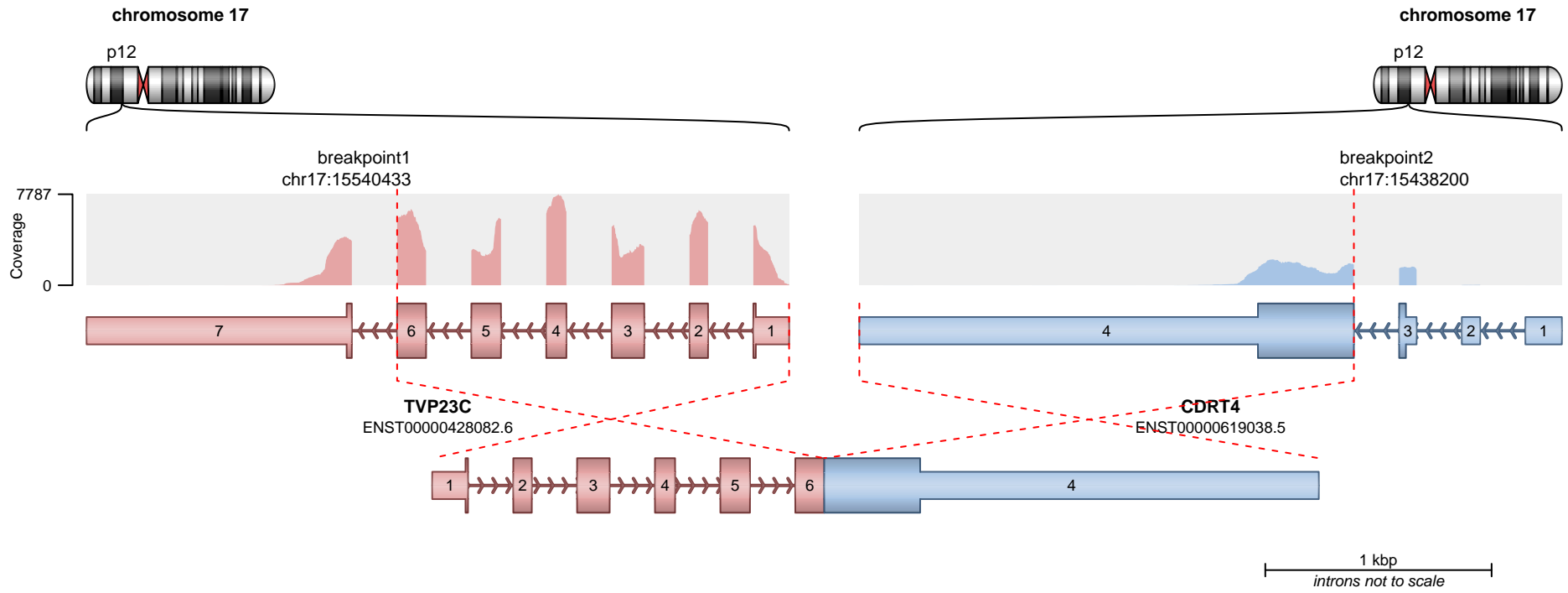

SUPPORTING READ COUNT

Split reads = 19
Discordant mates = 1

— translocation — deletion
— duplication — inversion

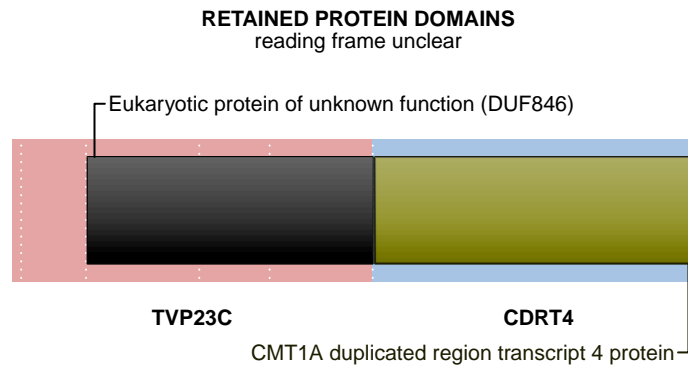
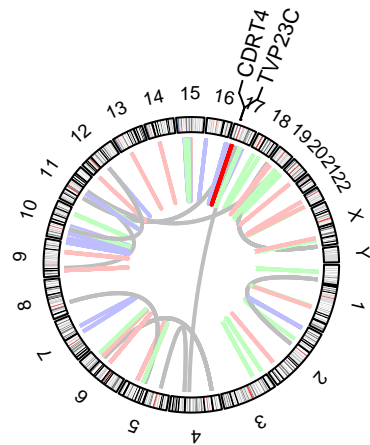
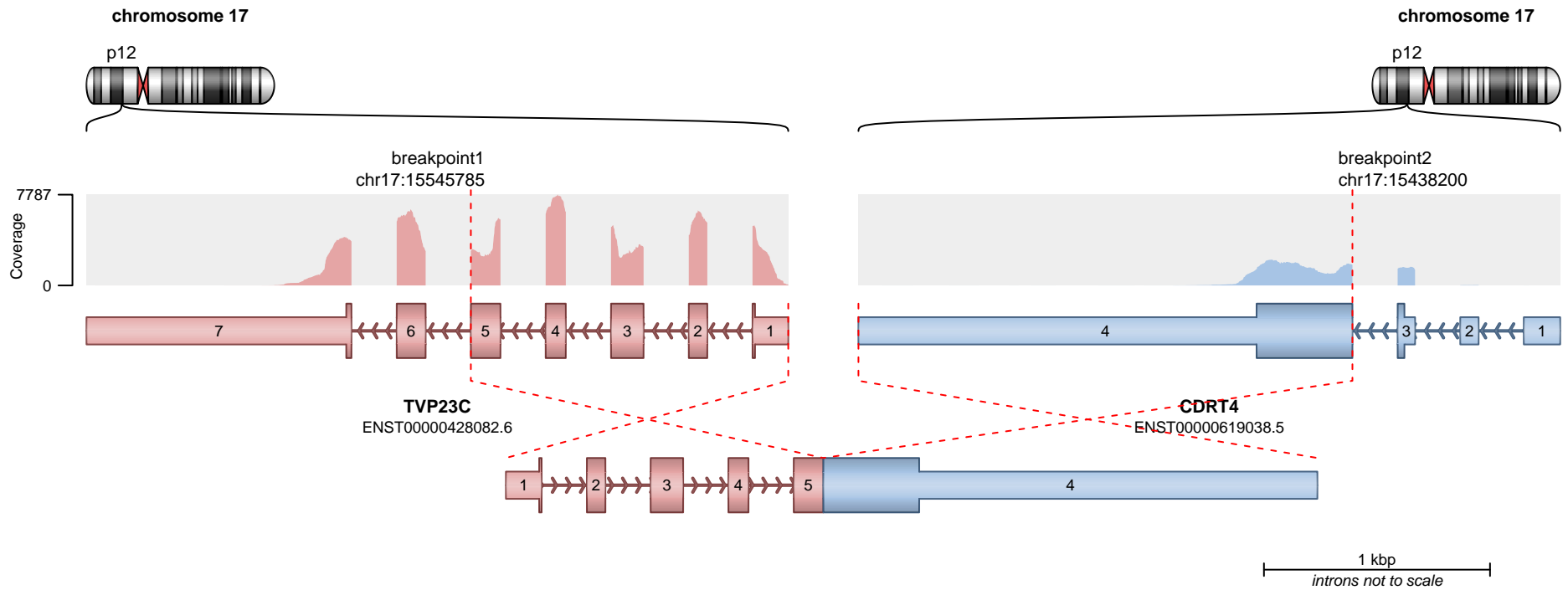

SUPPORTING READ COUNT

Split reads = 16
Discordant mates = 1

— translocation — deletion
— duplication — inversion

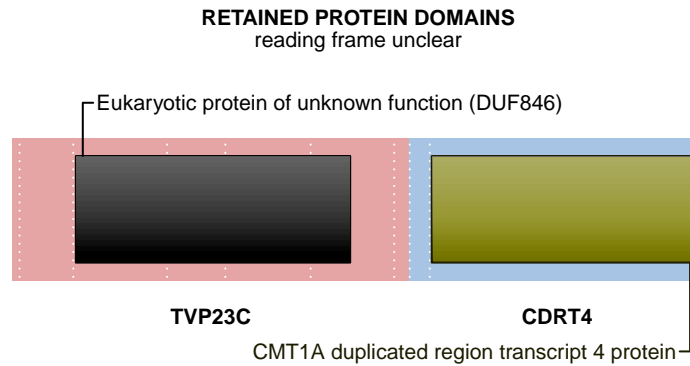
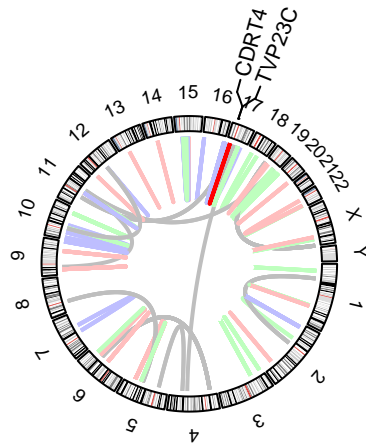
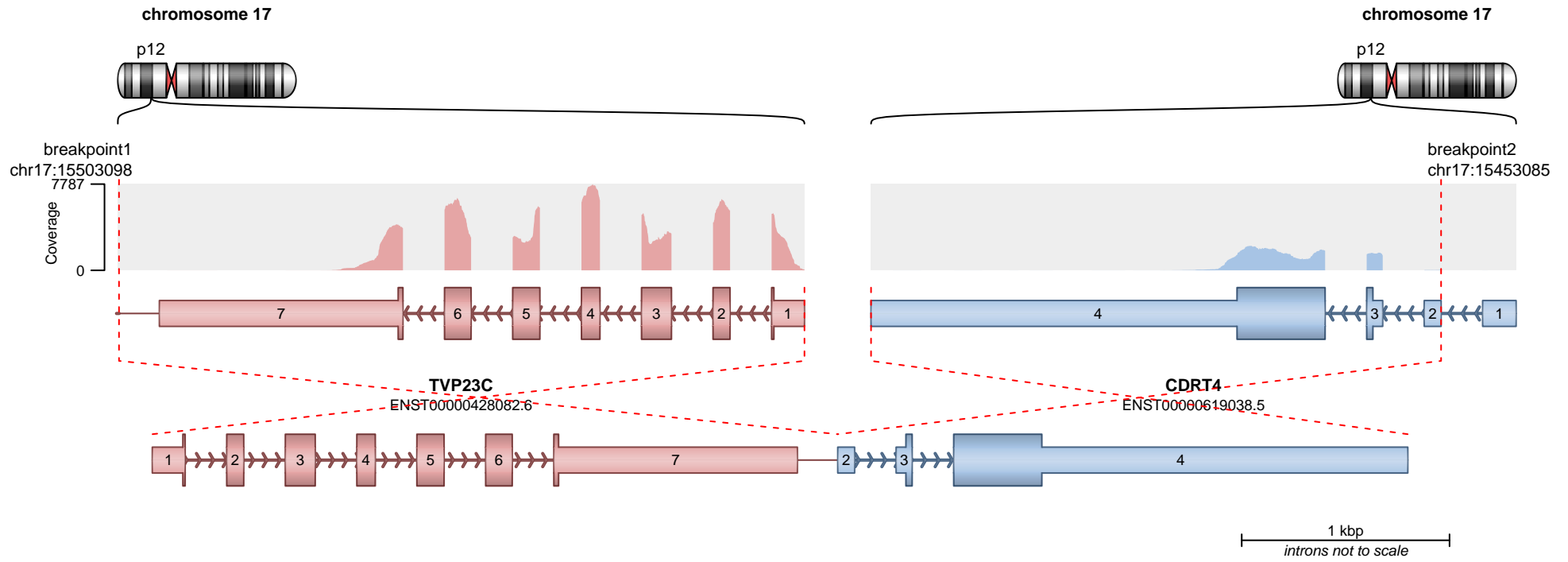

SUPPORTING READ COUNT

Split reads = 10
Discordant mates = 16

— translocation — deletion
— duplication — inversion

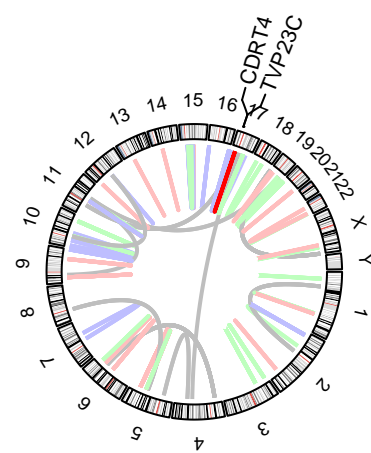
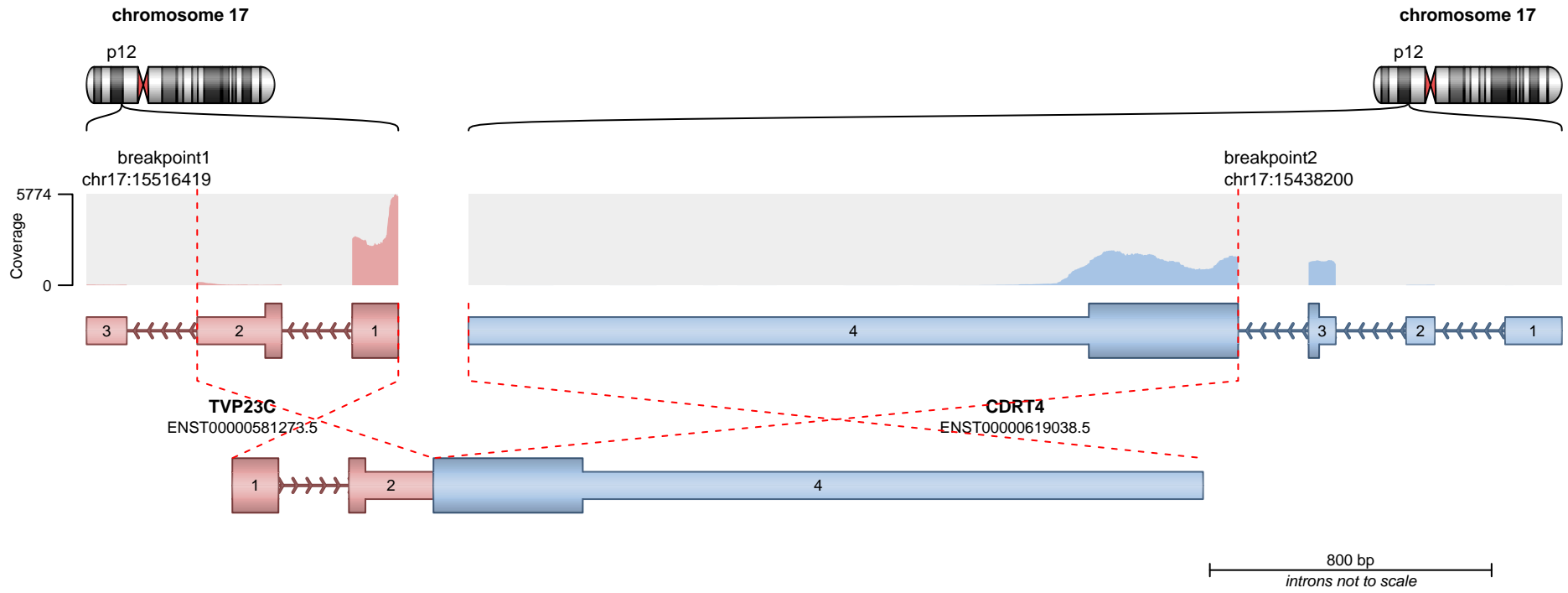

RETAINED PROTEIN DOMAINS
reading frame unclear

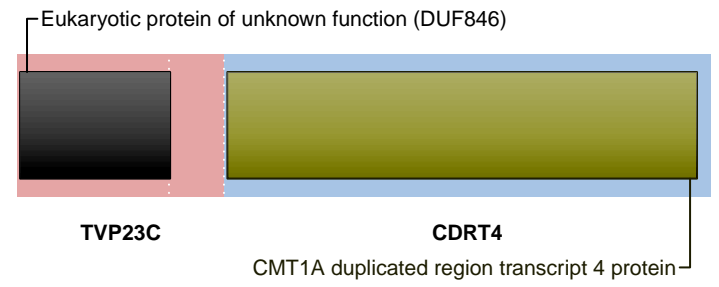

SUPPORTING READ COUNT

Split reads = 5
Discordant mates = 1

- translocation
- duplication
- deletion
- inversion

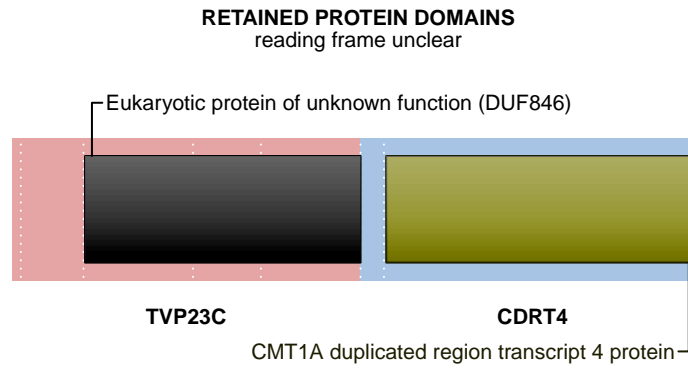
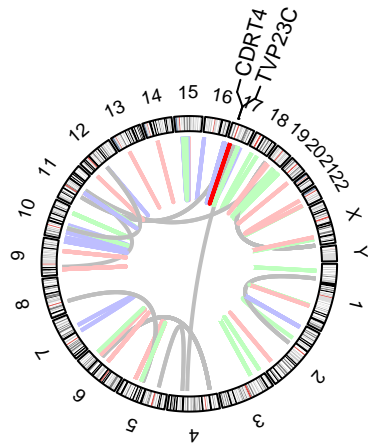
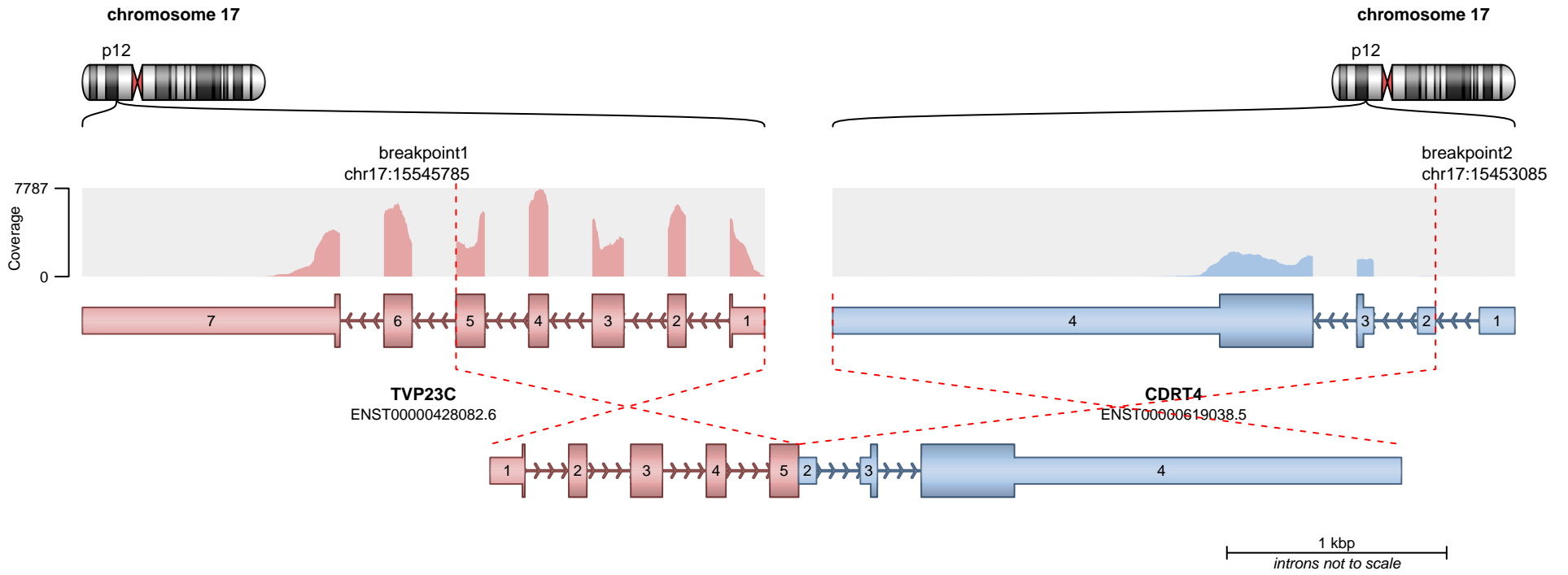

SUPPORTING READ COUNT

Split reads = 2
Discordant mates = 2

— translocation — deletion
— duplication — inversion

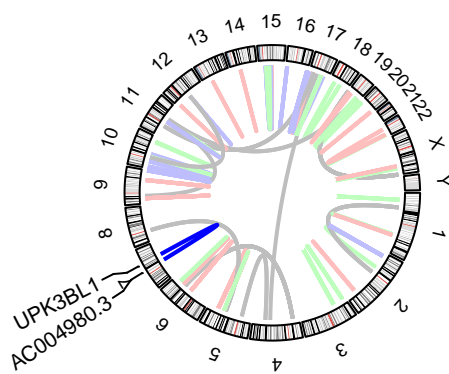
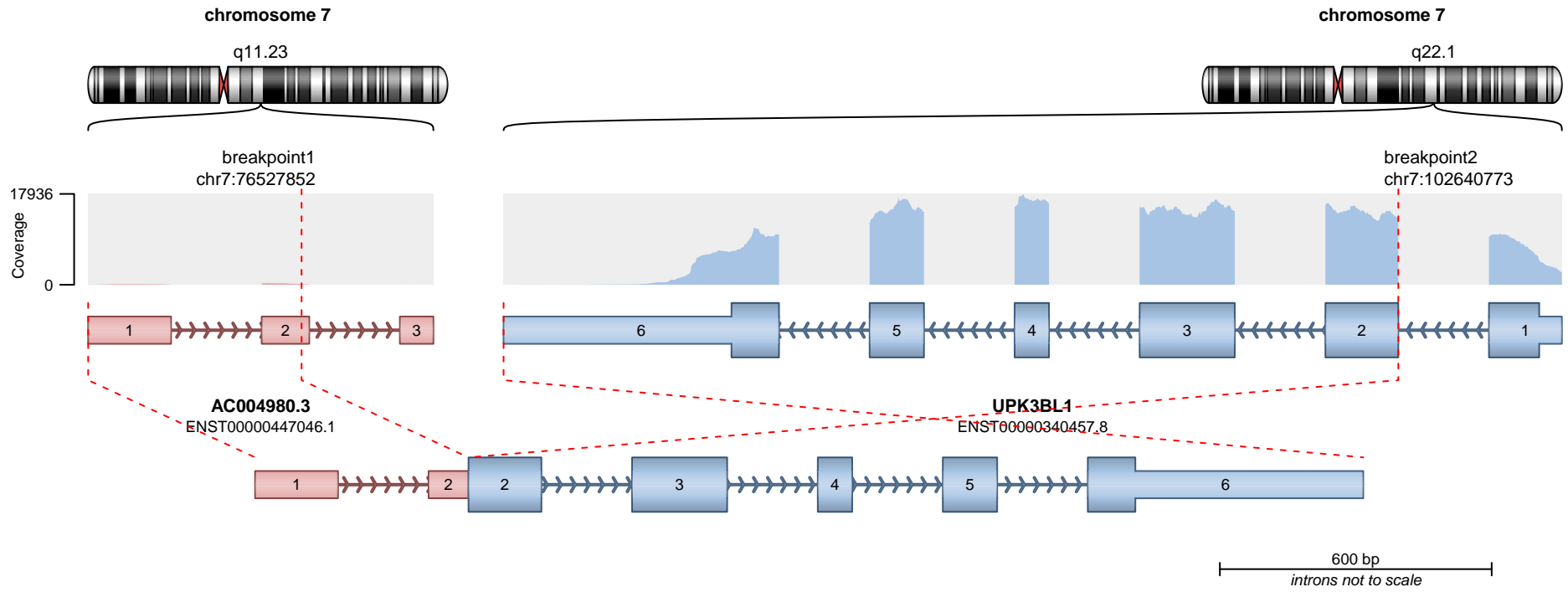

— translocation — deletion
— duplication — inversion

No protein domains retained in fusion.

SUPPORTING READ COUNT

Split reads = 276
Discordant mates = 4

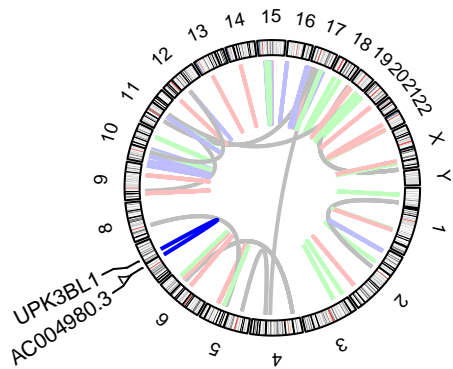
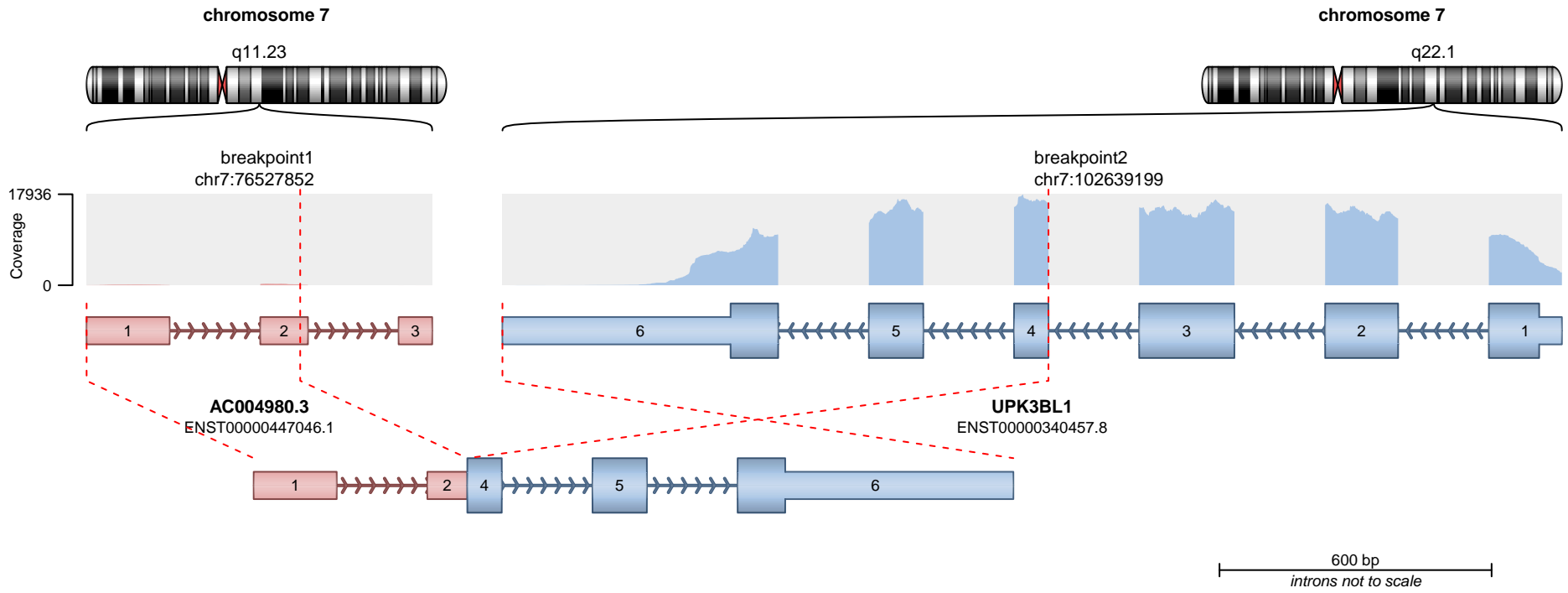

— translocation — deletion
— duplication — inversion

No protein domains retained in fusion.

SUPPORTING READ COUNT

Split reads = 10
Discordant mates = 0

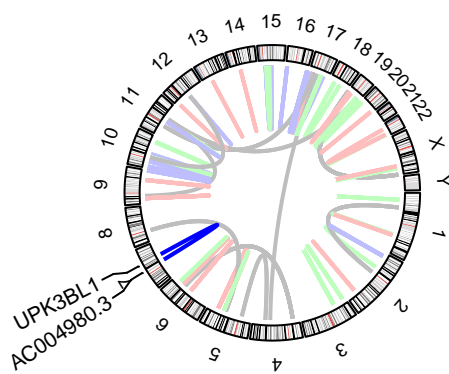
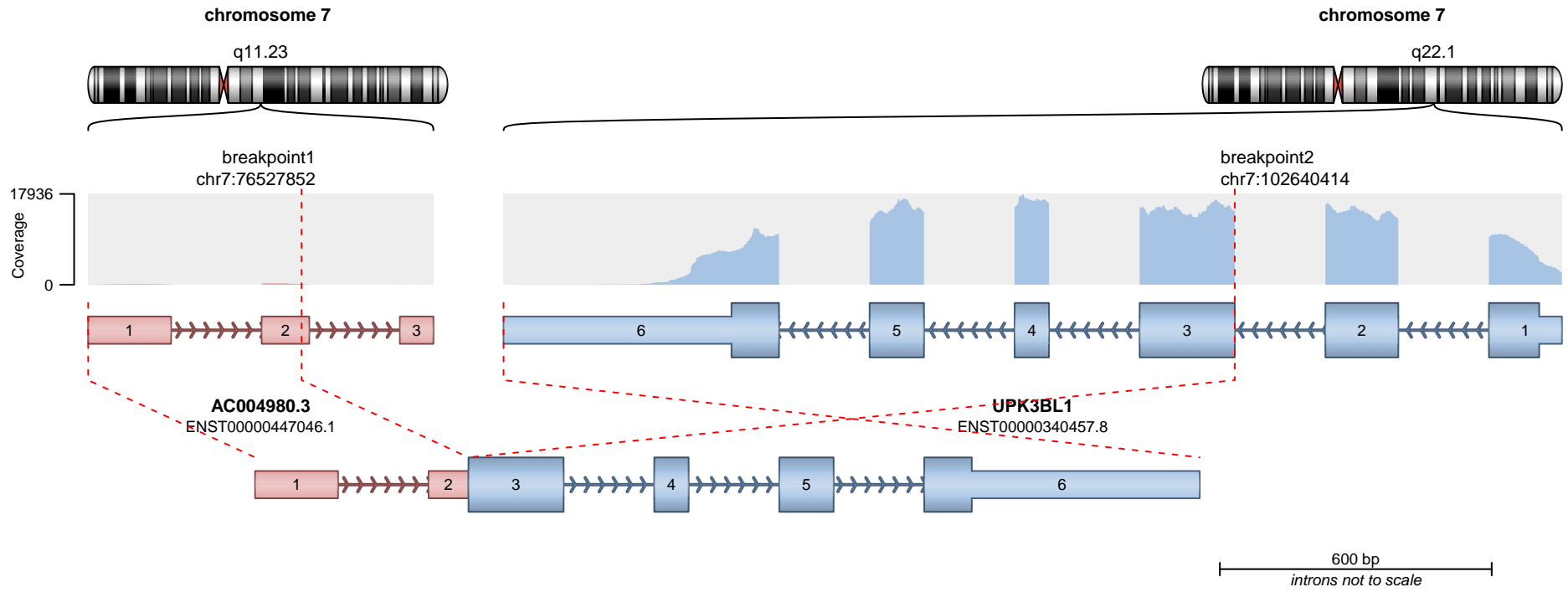

— translocation — deletion
— duplication — inversion

No protein domains retained in fusion.

SUPPORTING READ COUNT

Split reads = 3
Discordant mates = 0

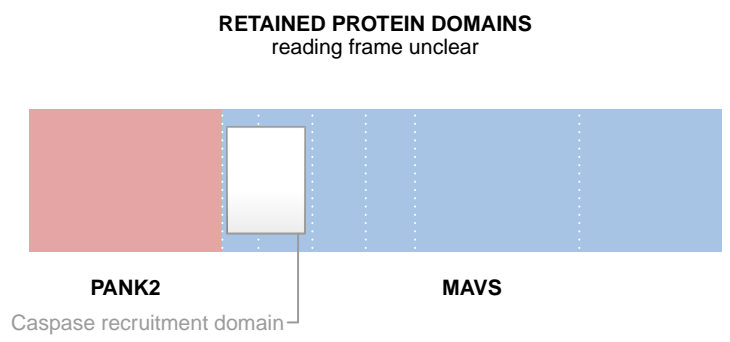
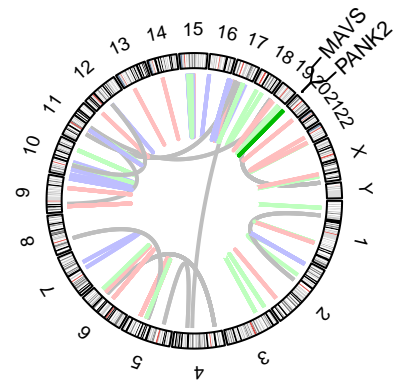
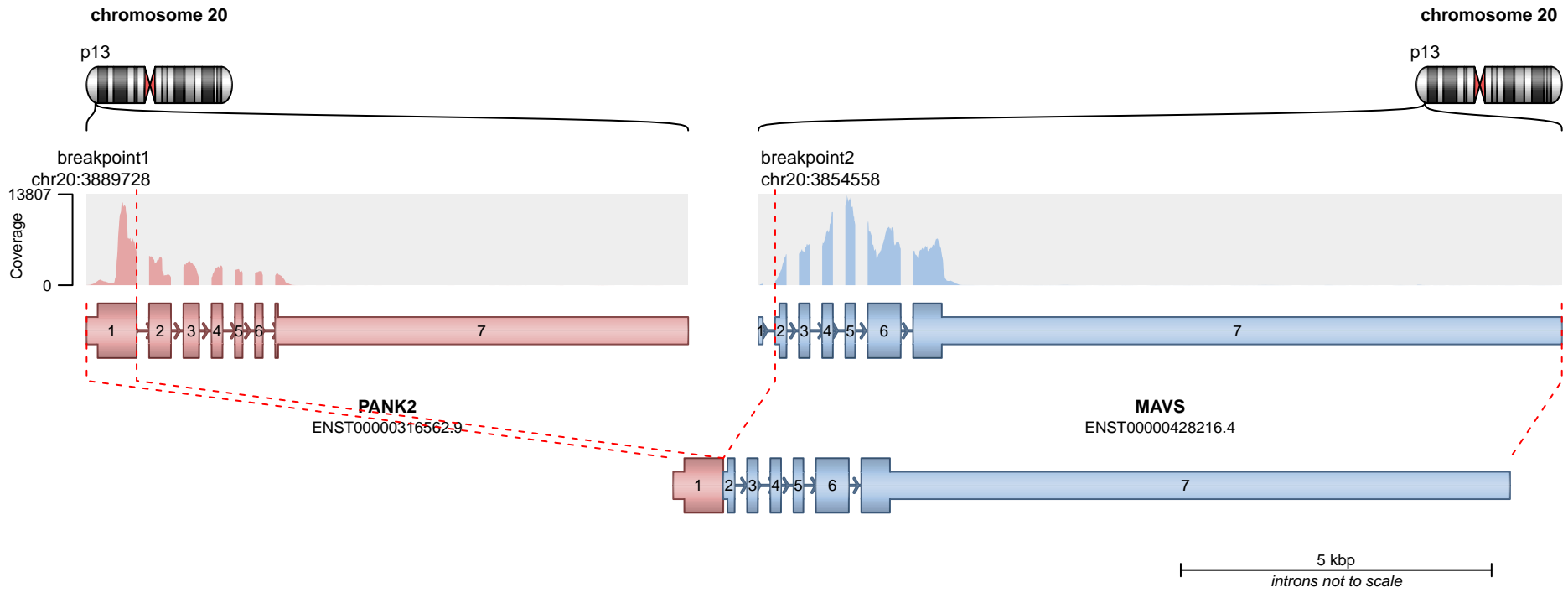

SUPPORTING READ COUNT

Split reads = 204
Discordant mates = 10

— translocation — deletion
— duplication — inversion

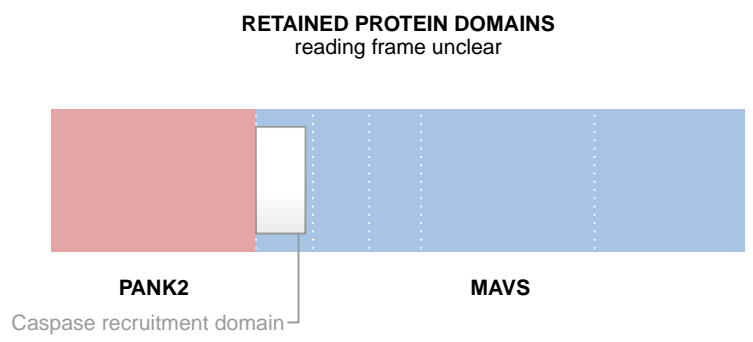
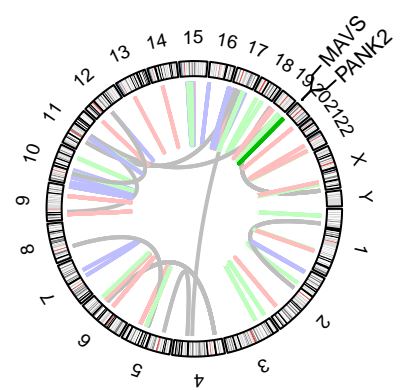
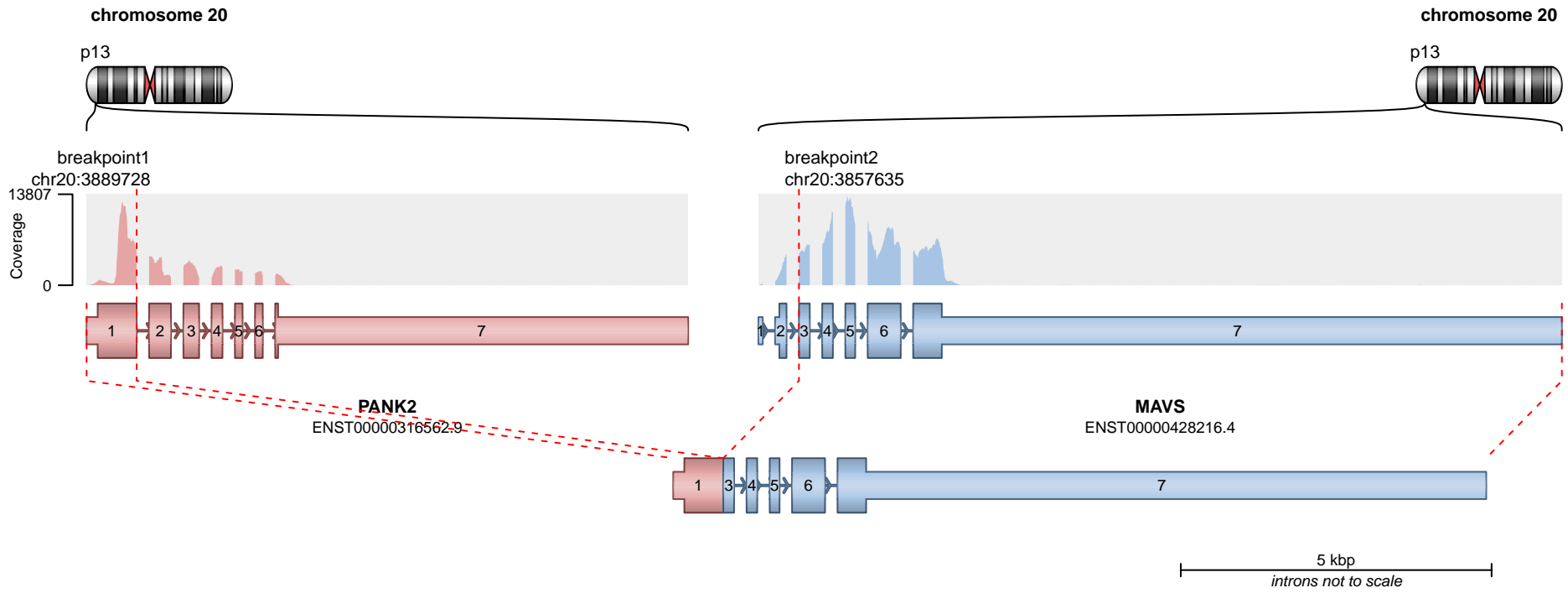

SUPPORTING READ COUNT

Split reads = 12
Discordant mates = 0

— translocation — deletion
— duplication — inversion

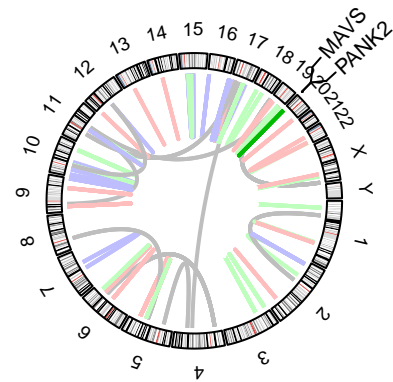
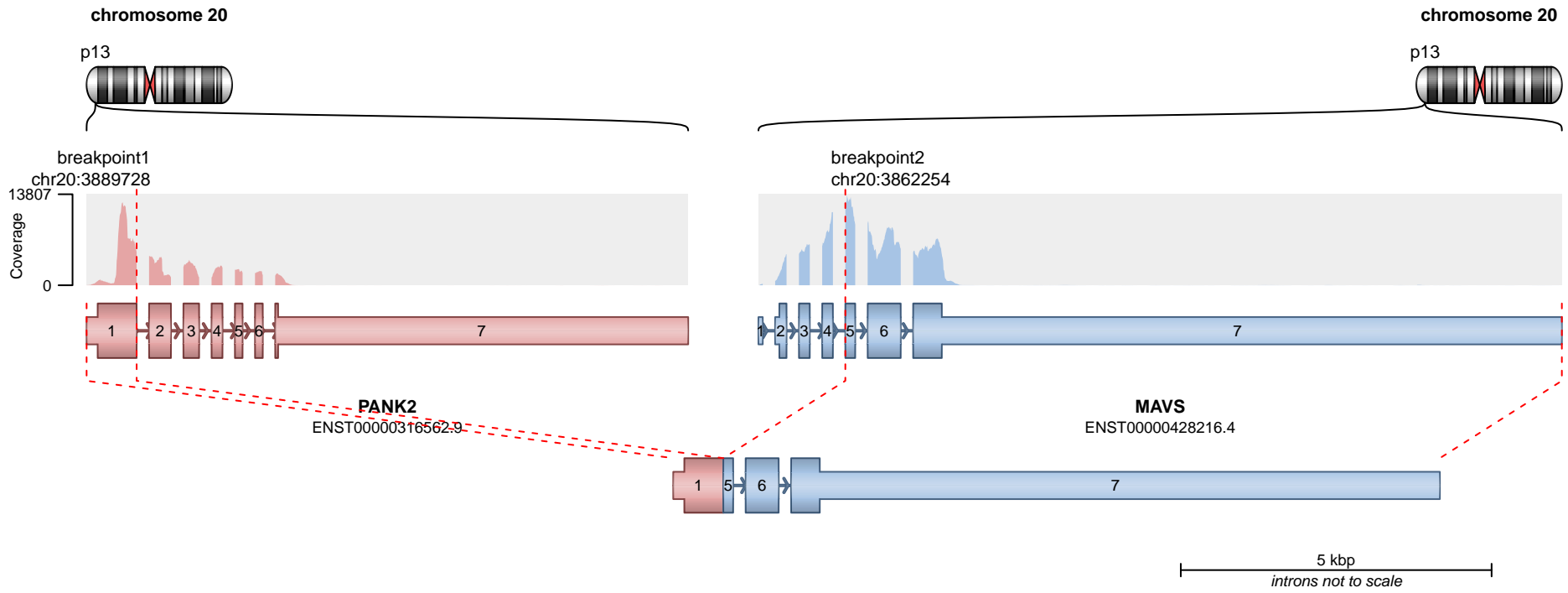

— translocation — deletion
— duplication — inversion

No protein domains retained in fusion.

SUPPORTING READ COUNT

Split reads = 2
Discordant mates = 0

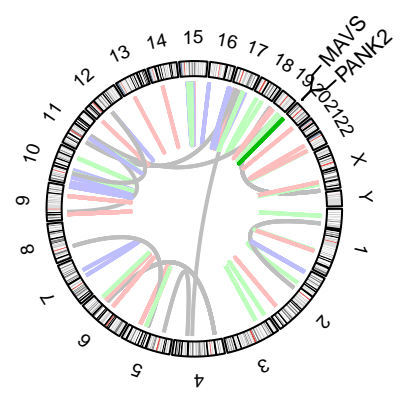
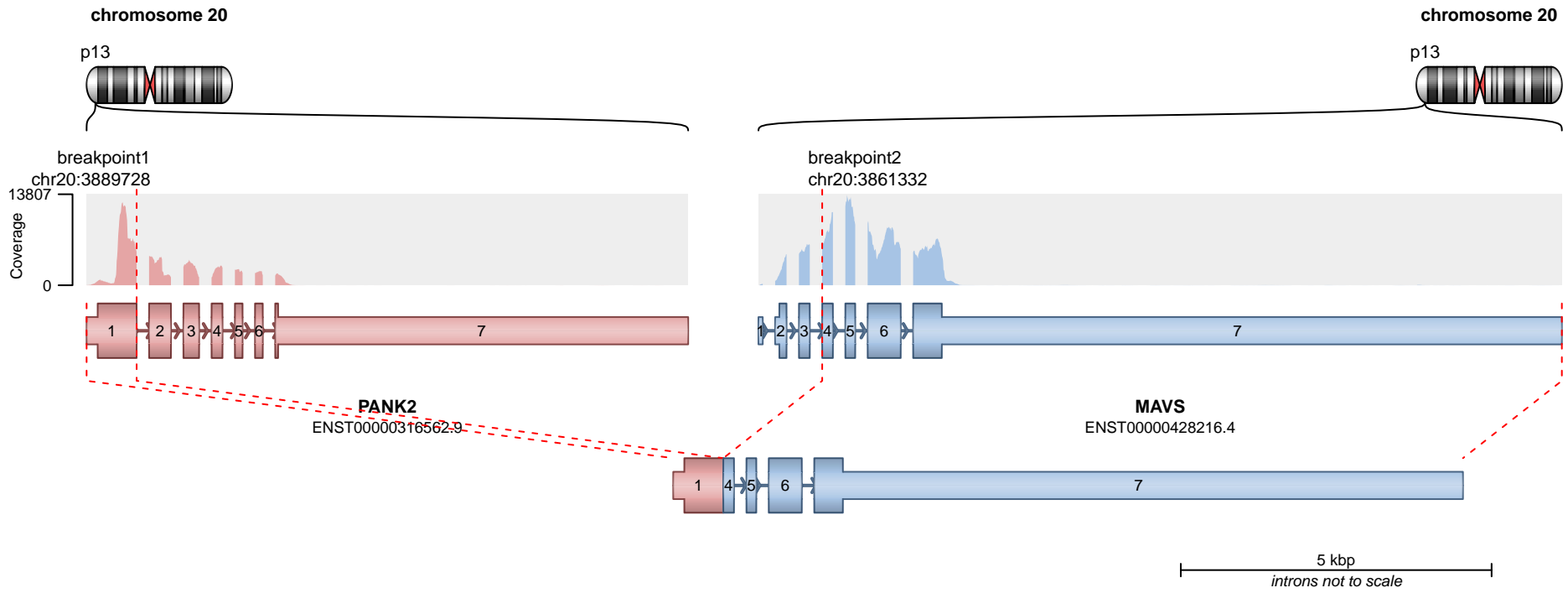

— translocation — deletion
— duplication — inversion

No protein domains retained in fusion.

SUPPORTING READ COUNT

Split reads = 2
Discordant mates = 0

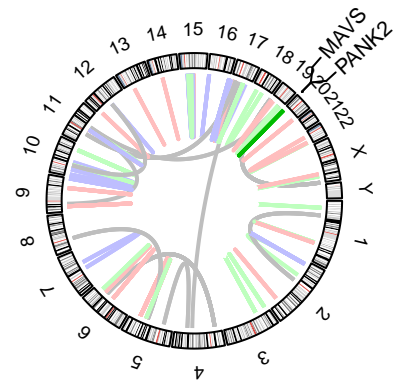
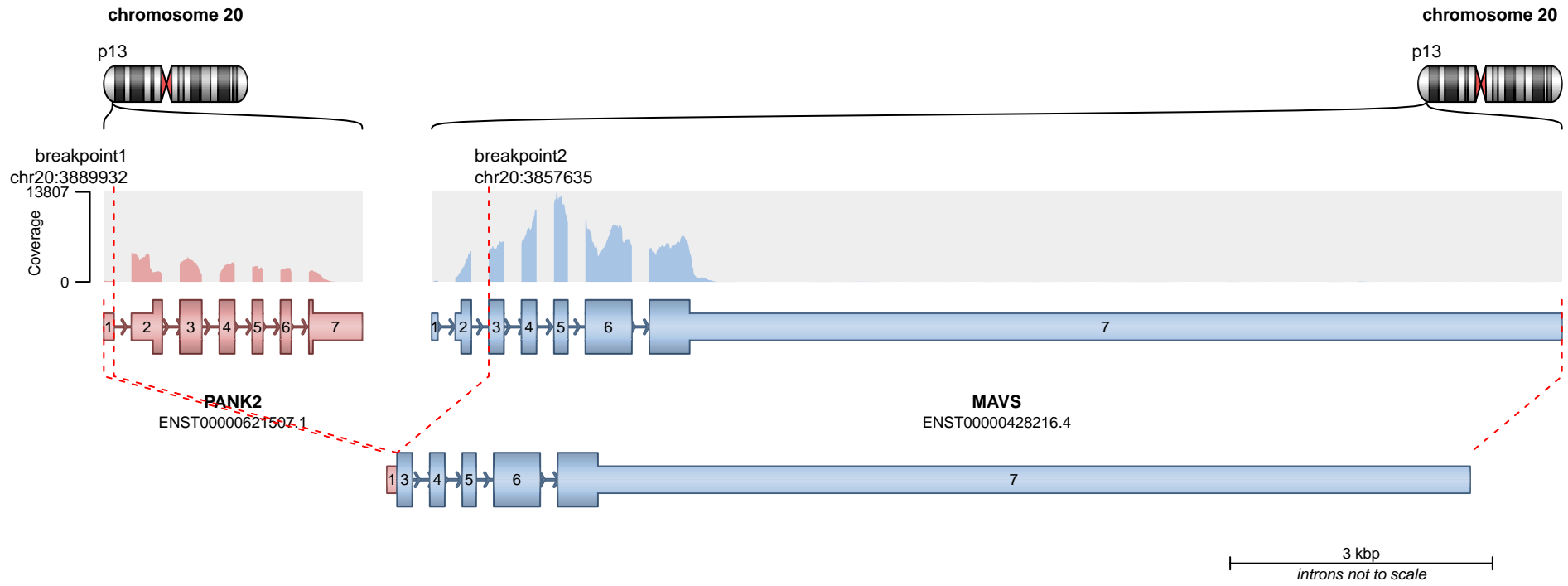

— translocation — deletion
 — duplication — inversion

RETAINED PROTEIN DOMAINS
reading frame unclear

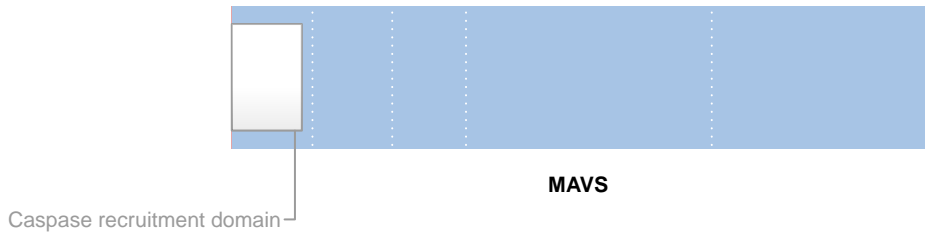

SUPPORTING READ COUNT

Split reads = 1
Discordant mates = 0

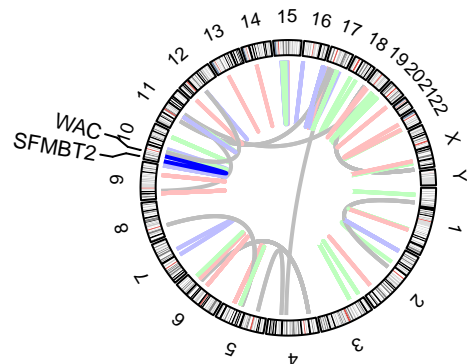
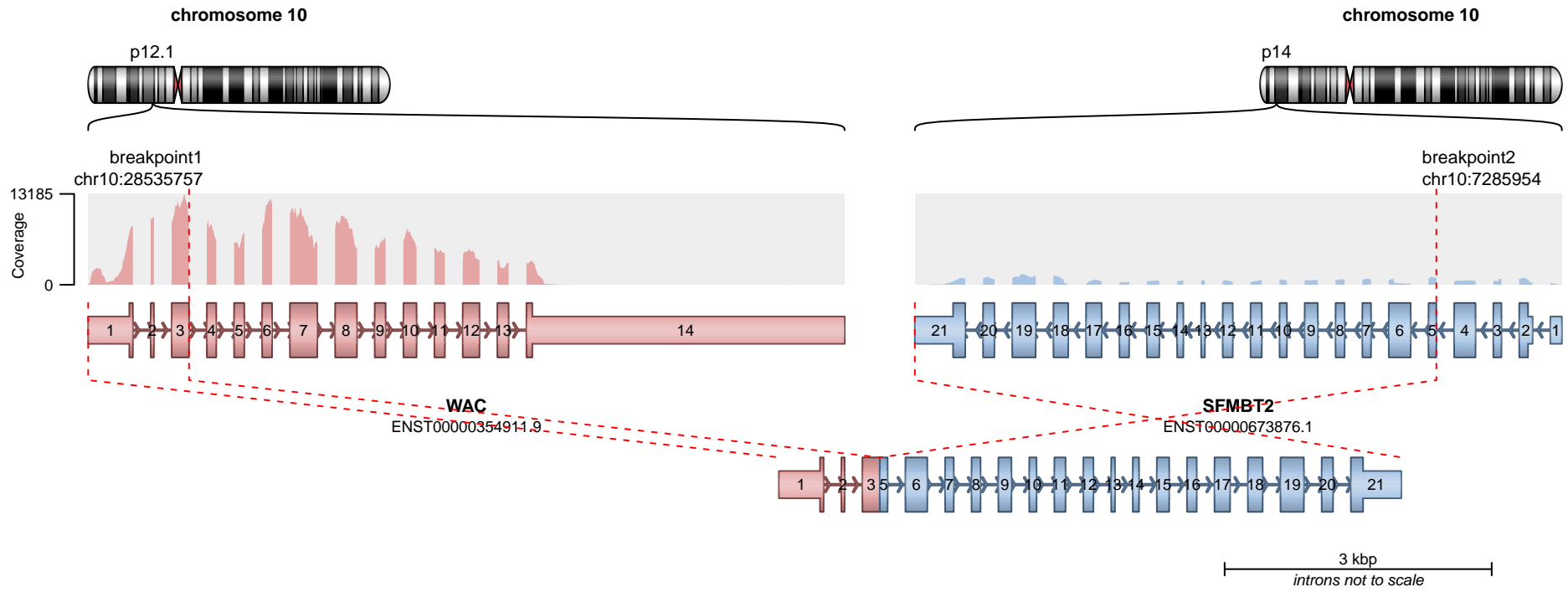

— translocation — deletion
— duplication — inversion

RETAINED PROTEIN DOMAINS
reading frame unclear

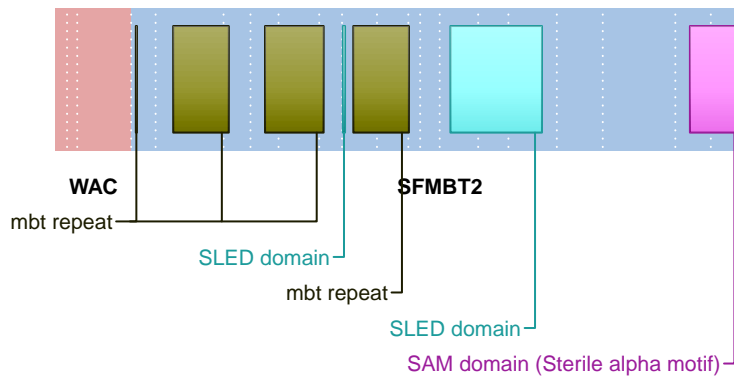

SUPPORTING READ COUNT

Split reads = 188
Discordant mates = 3

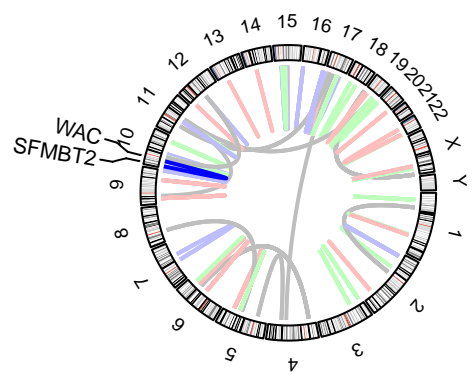
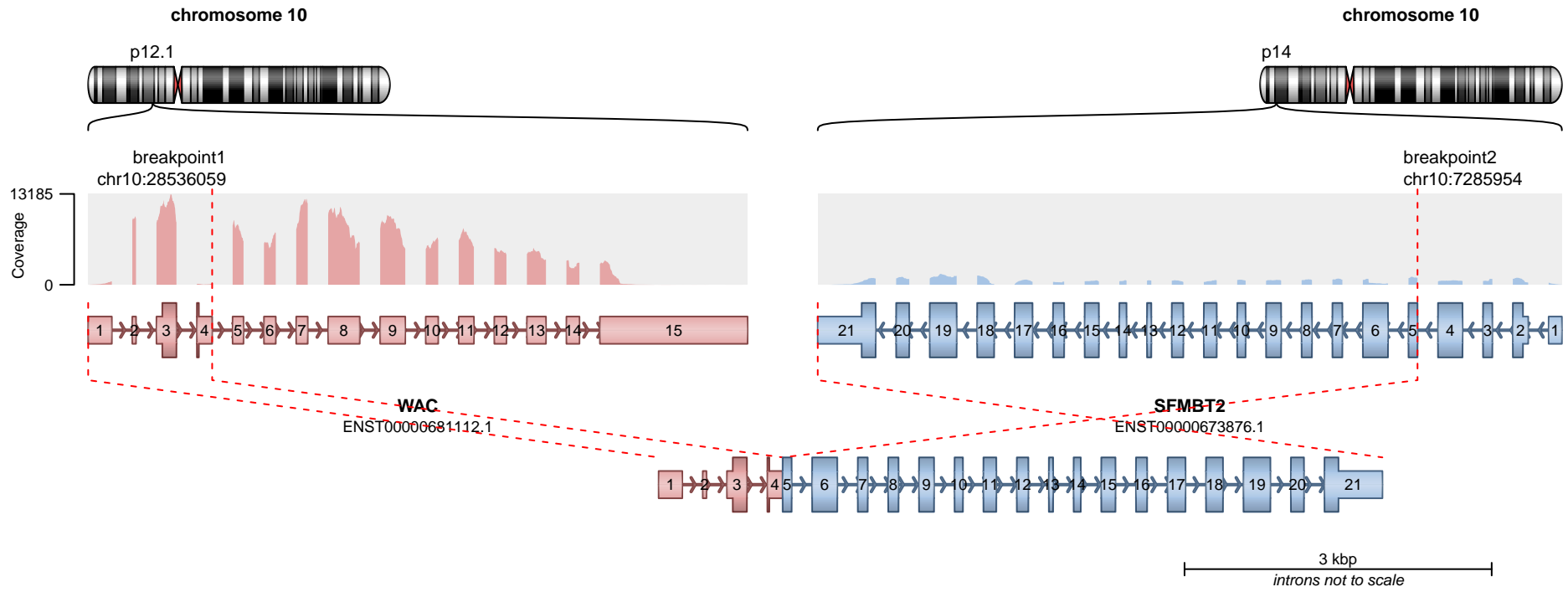

— translocation — deletion
— duplication — inversion

RETAINED PROTEIN DOMAINS
reading frame unclear

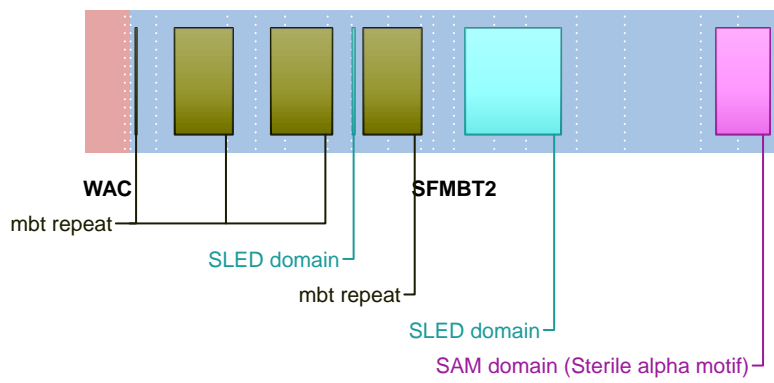

SUPPORTING READ COUNT

Split reads = 2
Discordant mates = 3

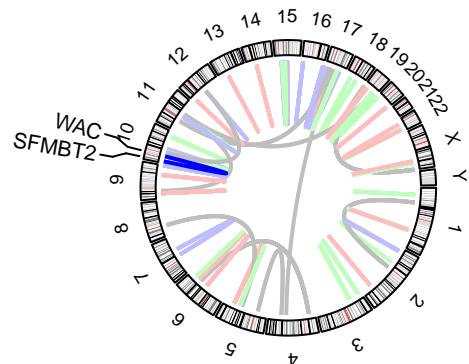
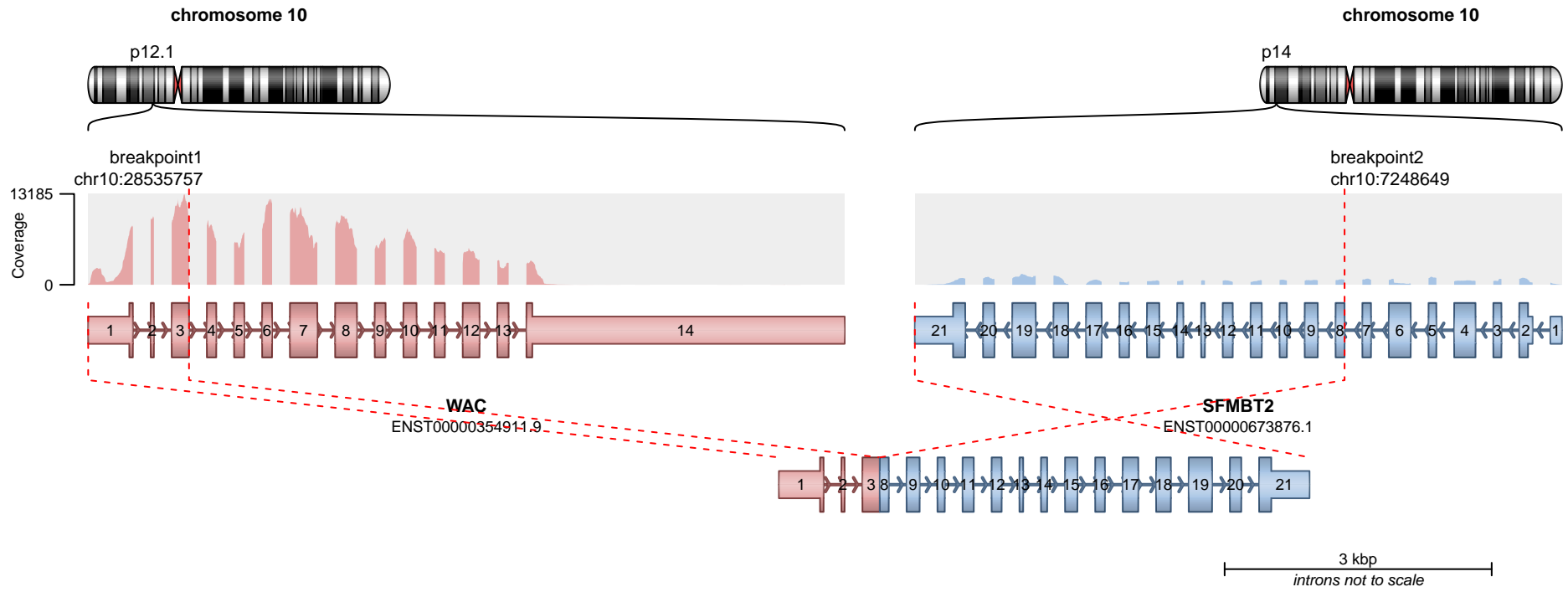

— translocation — deletion
— duplication — inversion

RETAINED PROTEIN DOMAINS
reading frame unclear

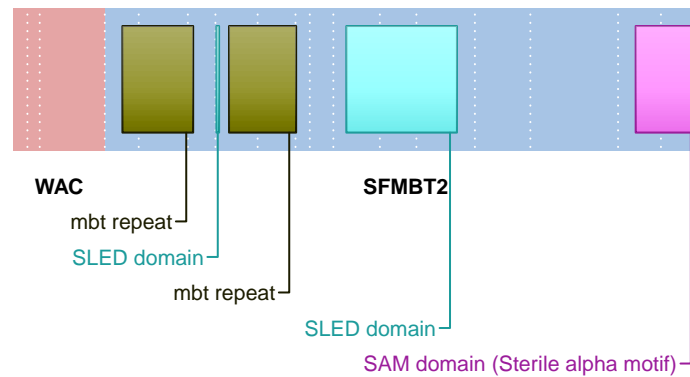

SUPPORTING READ COUNT

Split reads = 1
Discordant mates = 0

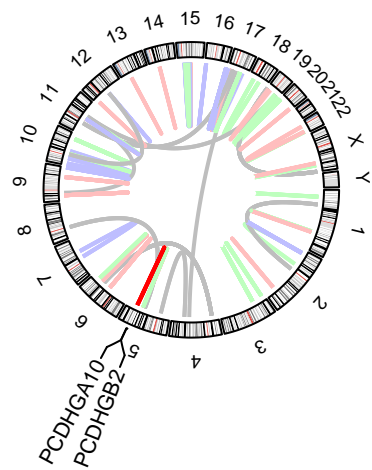
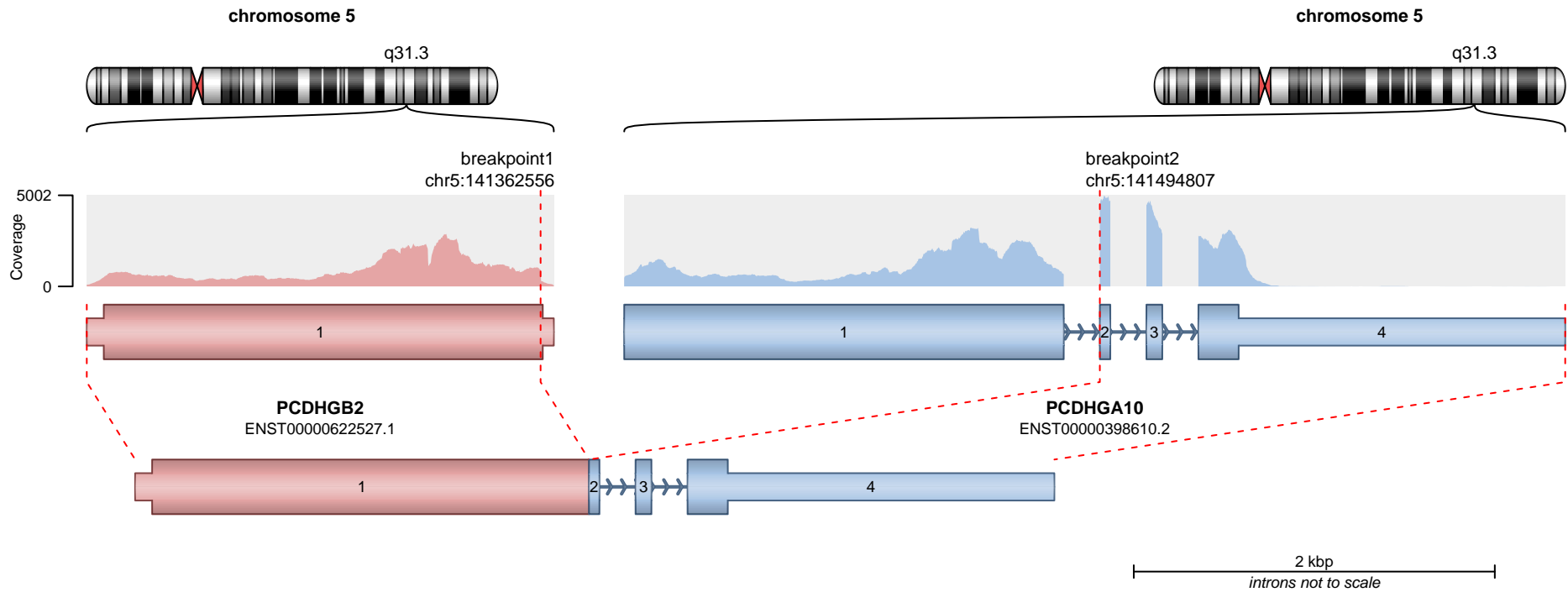

— translocation — deletion
— duplication — inversion

RETAINED PROTEIN DOMAINS
reading frame unclear

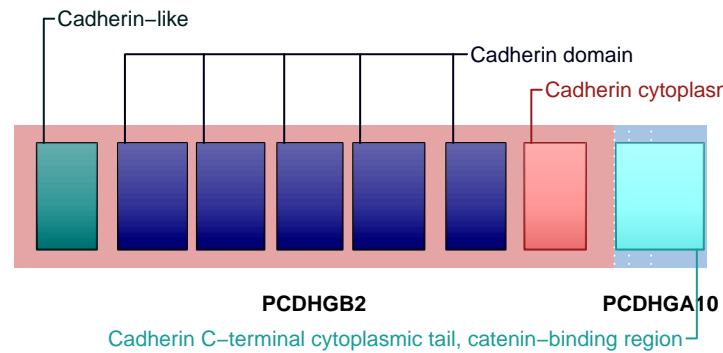

SUPPORTING READ COUNT

Split reads = 180
Discordant mates = 6

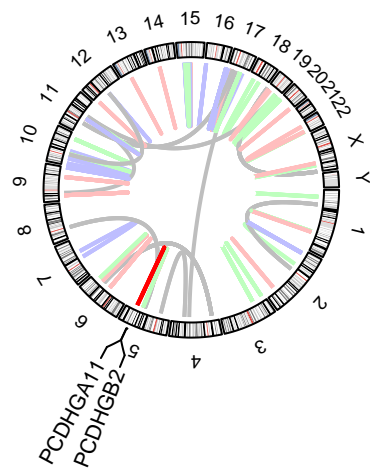
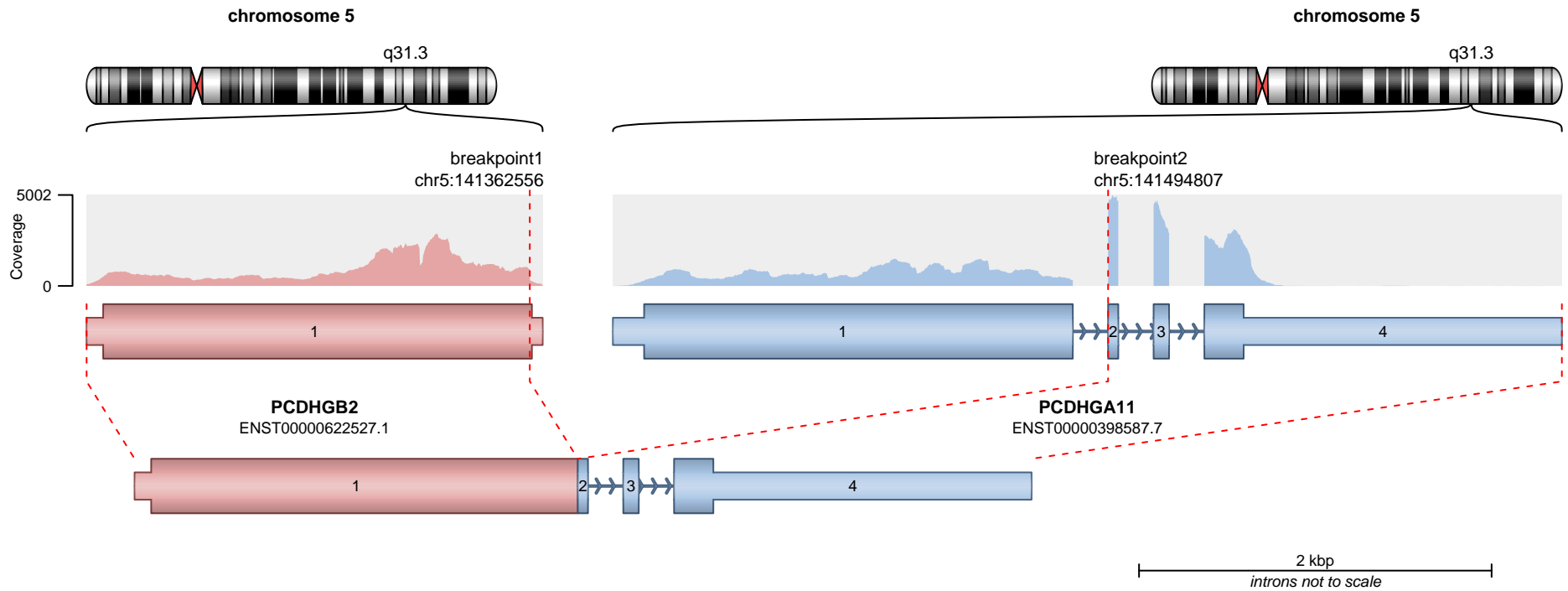

— translocation — deletion
— duplication — inversion

RETAINED PROTEIN DOMAINS
reading frame unclear

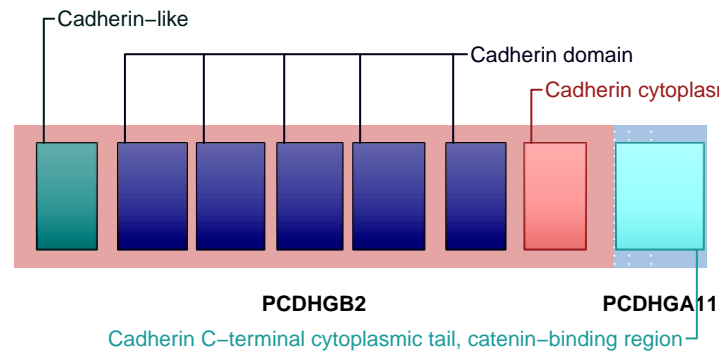

SUPPORTING READ COUNT

Split reads = 180
Discordant mates = 6

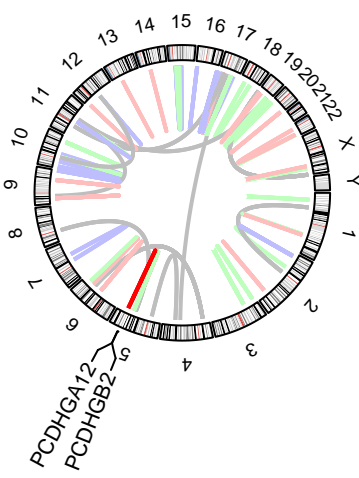
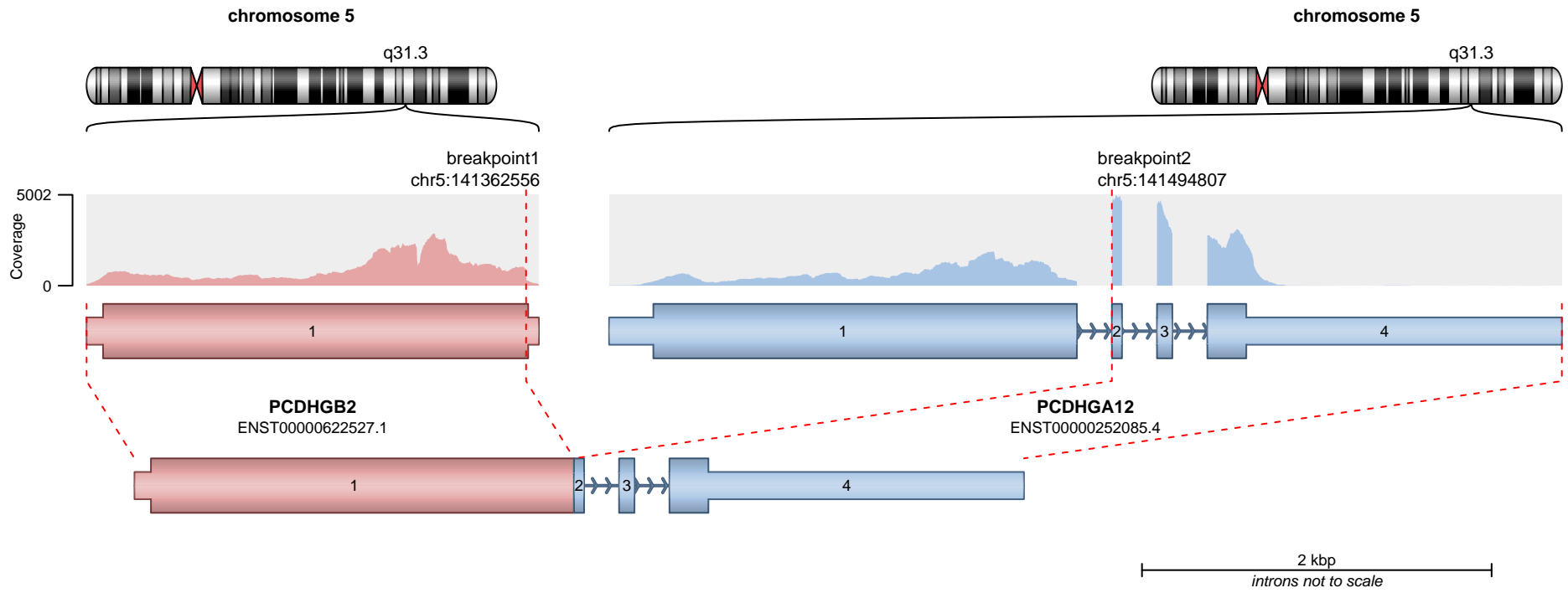

— translocation — deletion
— duplication — inversion

RETAINED PROTEIN DOMAINS
reading frame unclear

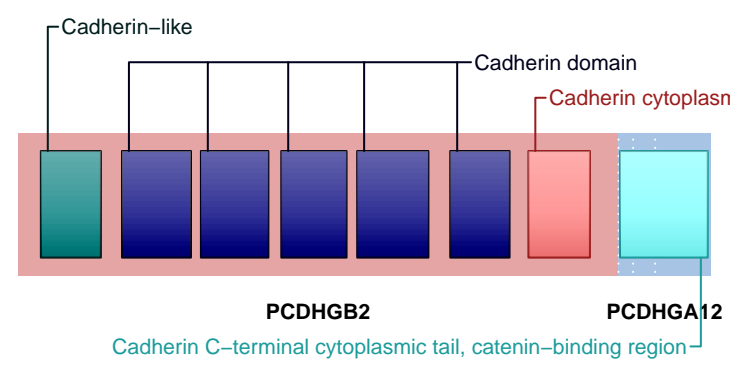

SUPPORTING READ COUNT

Split reads = 180
Discordant mates = 6

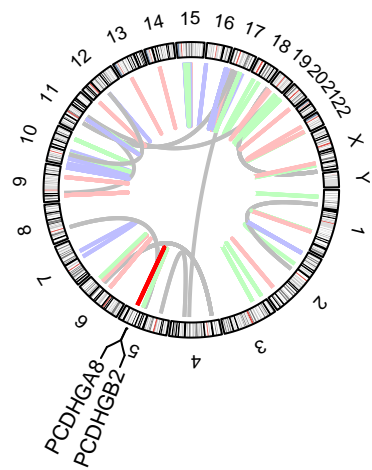
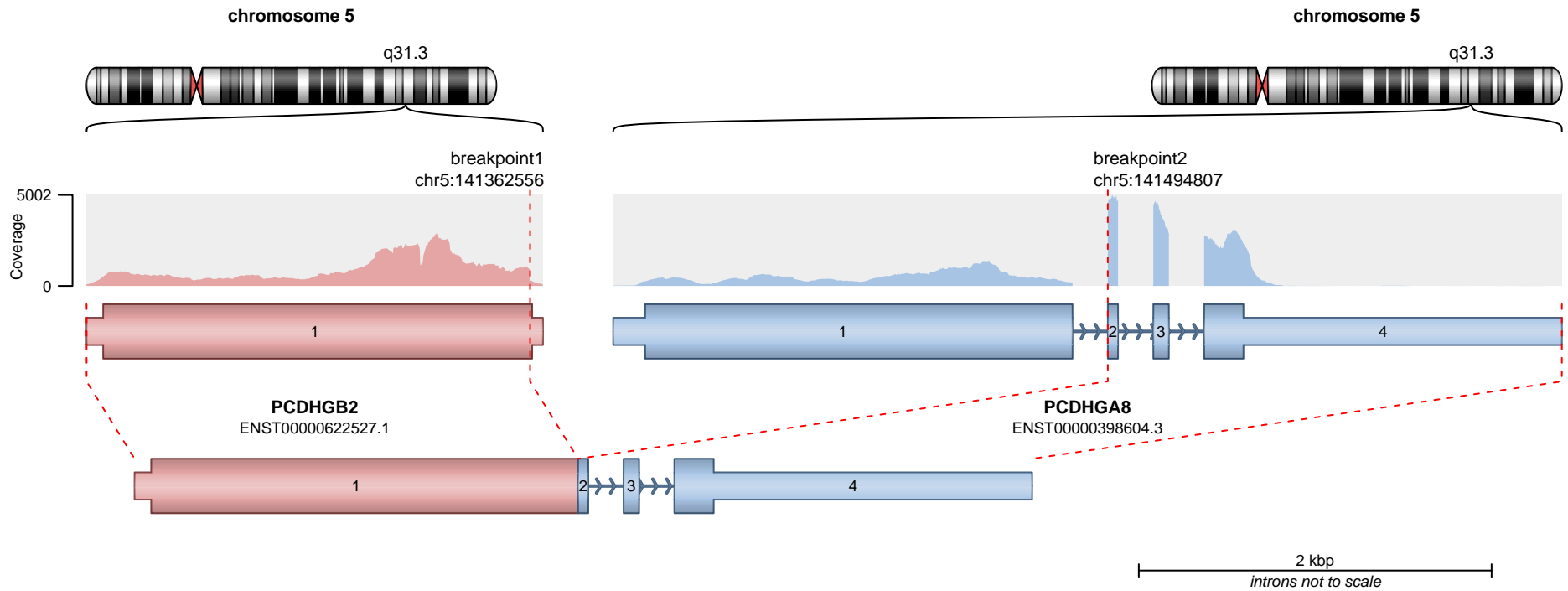

— translocation — deletion
— duplication — inversion

RETAINED PROTEIN DOMAINS
reading frame unclear

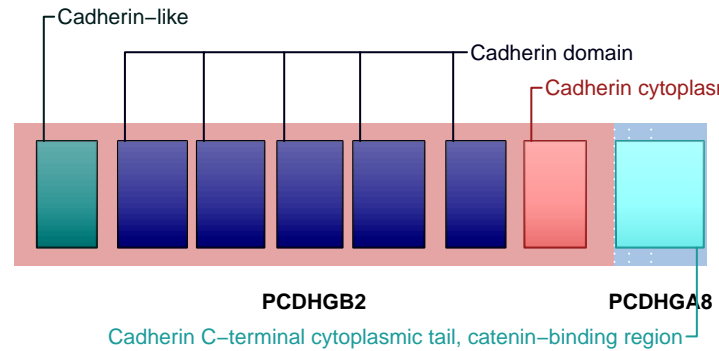

SUPPORTING READ COUNT

Split reads = 180
Discordant mates = 6

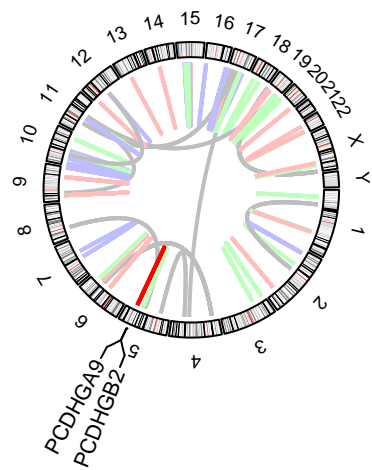
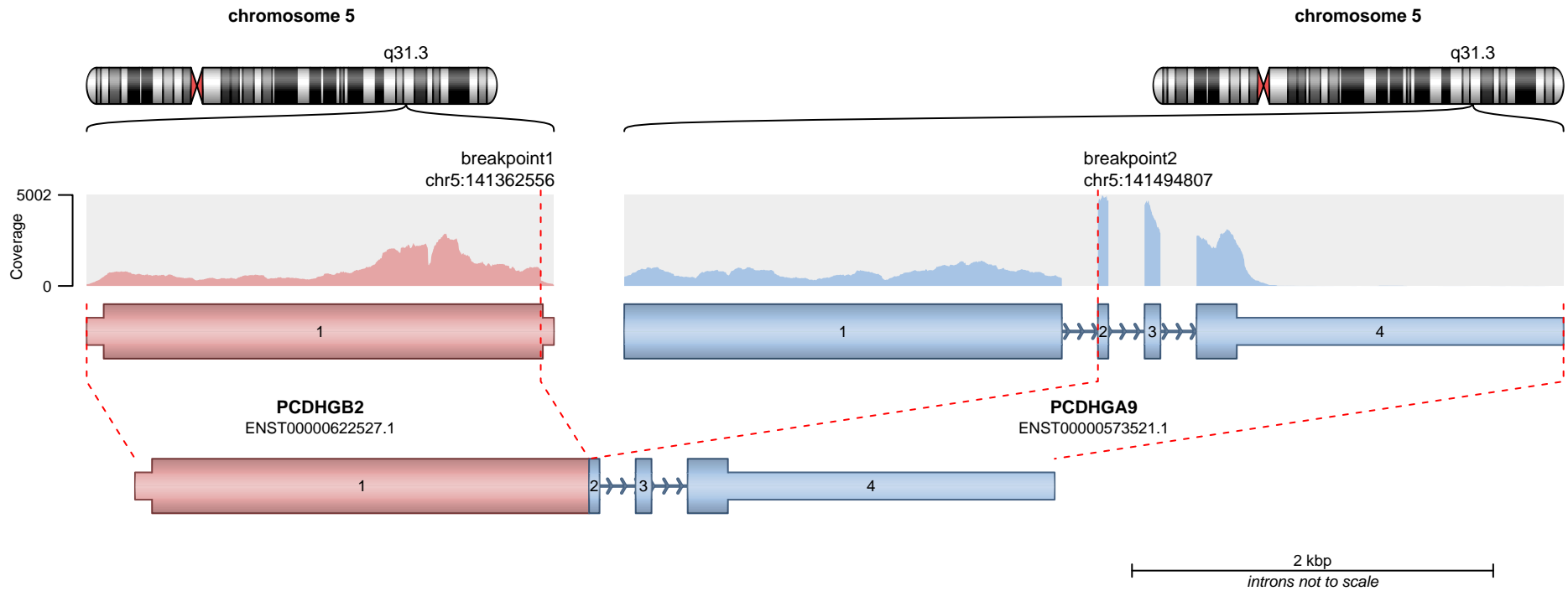

— translocation — deletion
— duplication — inversion

RETAINED PROTEIN DOMAINS
reading frame unclear

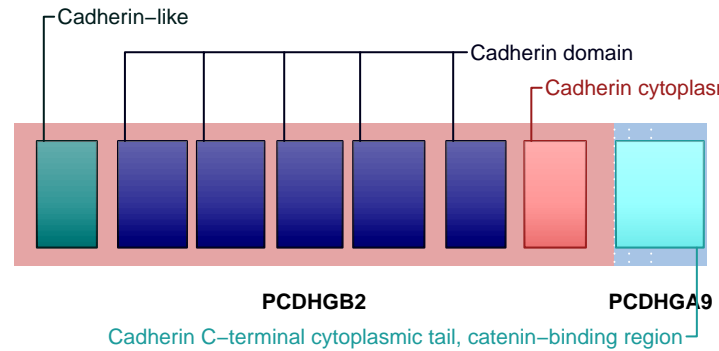

SUPPORTING READ COUNT

Split reads = 180
Discordant mates = 6

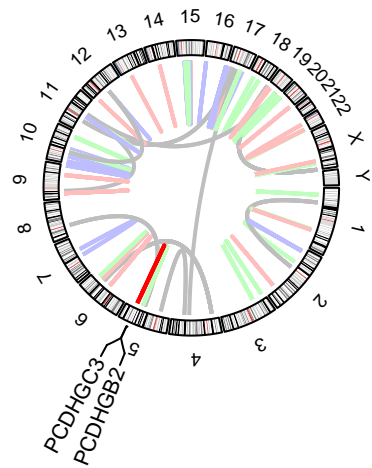
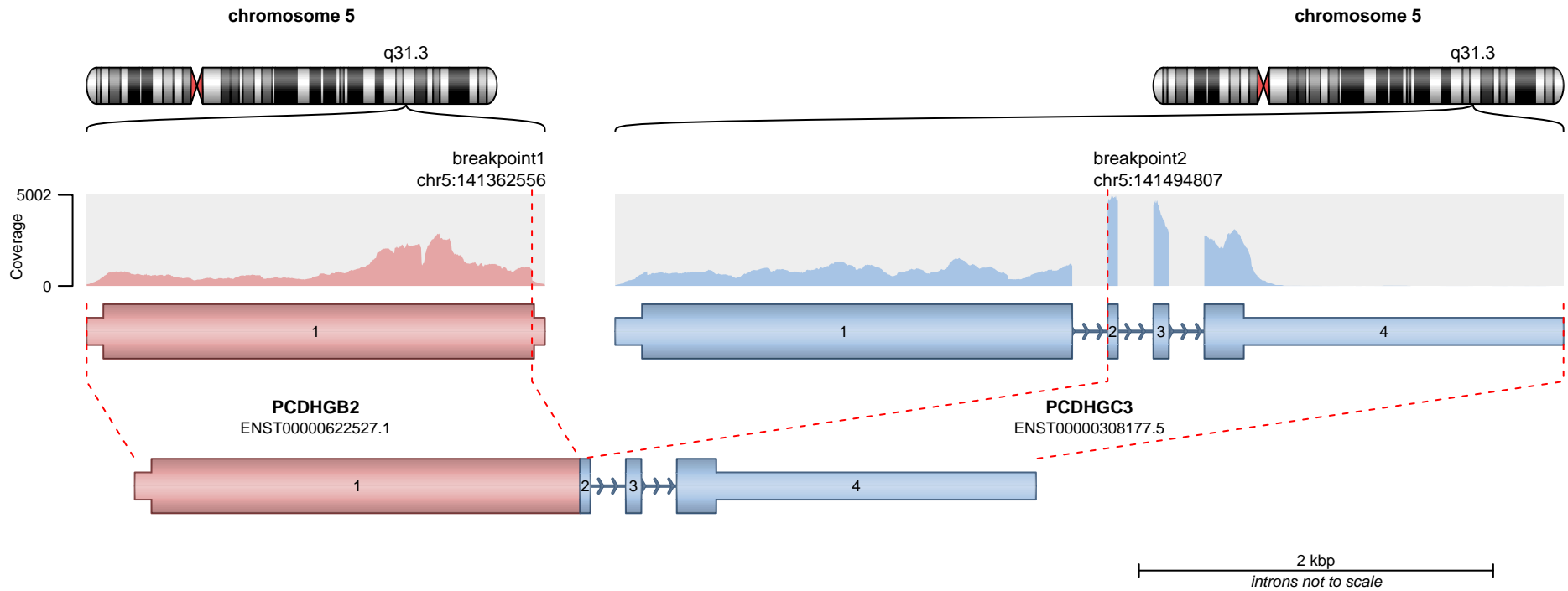

— translocation — deletion
— duplication — inversion

RETAINED PROTEIN DOMAINS
reading frame unclear

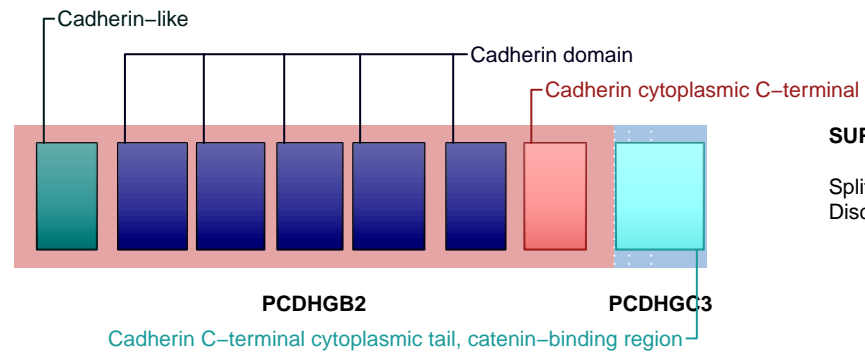

SUPPORTING READ COUNT

Split reads = 180
Discordant mates = 6

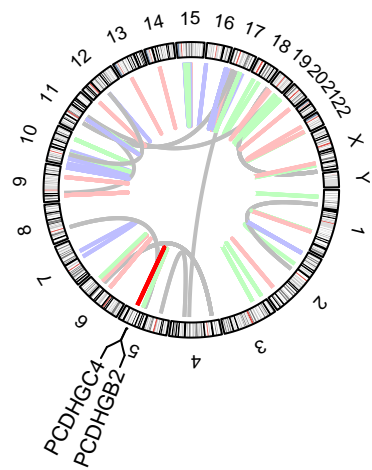
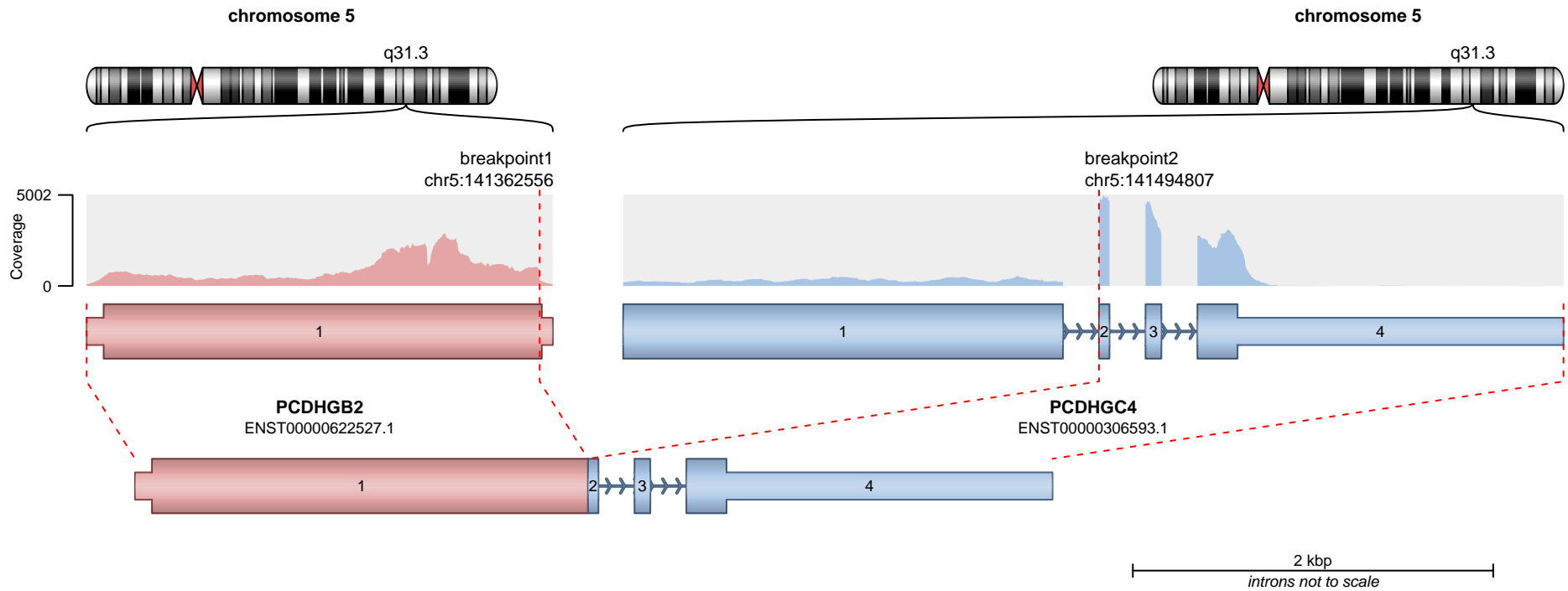

— translocation — deletion
— duplication — inversion

RETAINED PROTEIN DOMAINS
reading frame unclear

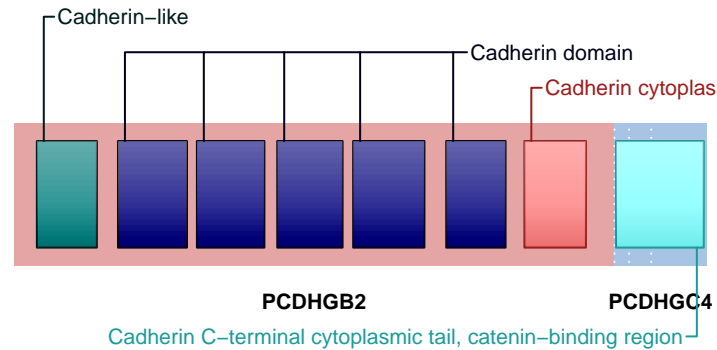

SUPPORTING READ COUNT

Split reads = 180
Discordant mates = 6

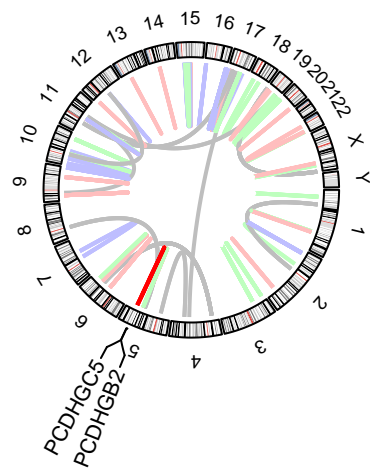
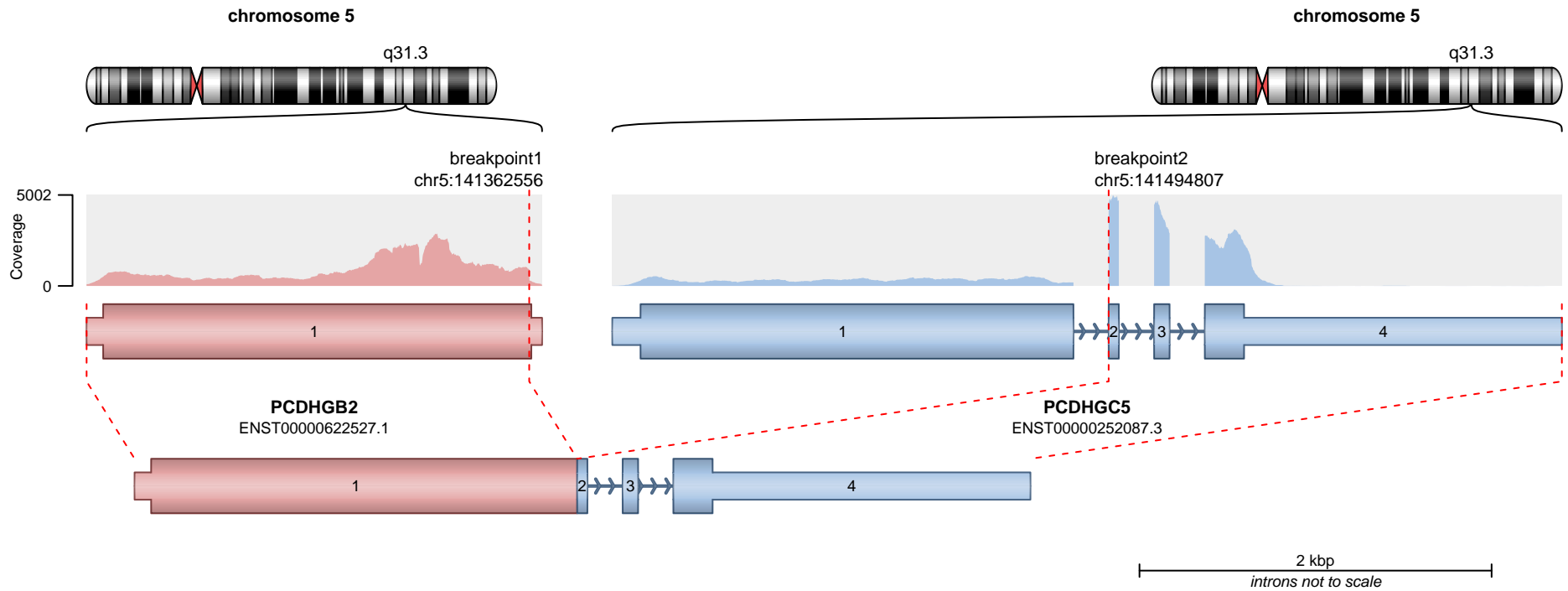

RETAINED PROTEIN DOMAINS
reading frame unclear

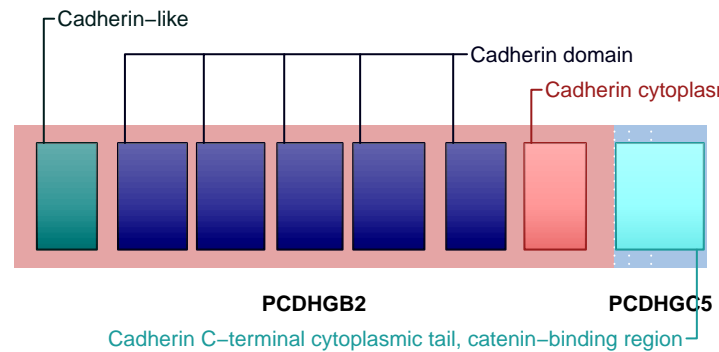

SUPPORTING READ COUNT

Split reads = 180
Discordant mates = 6

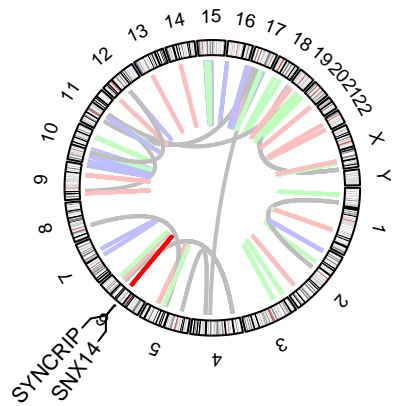
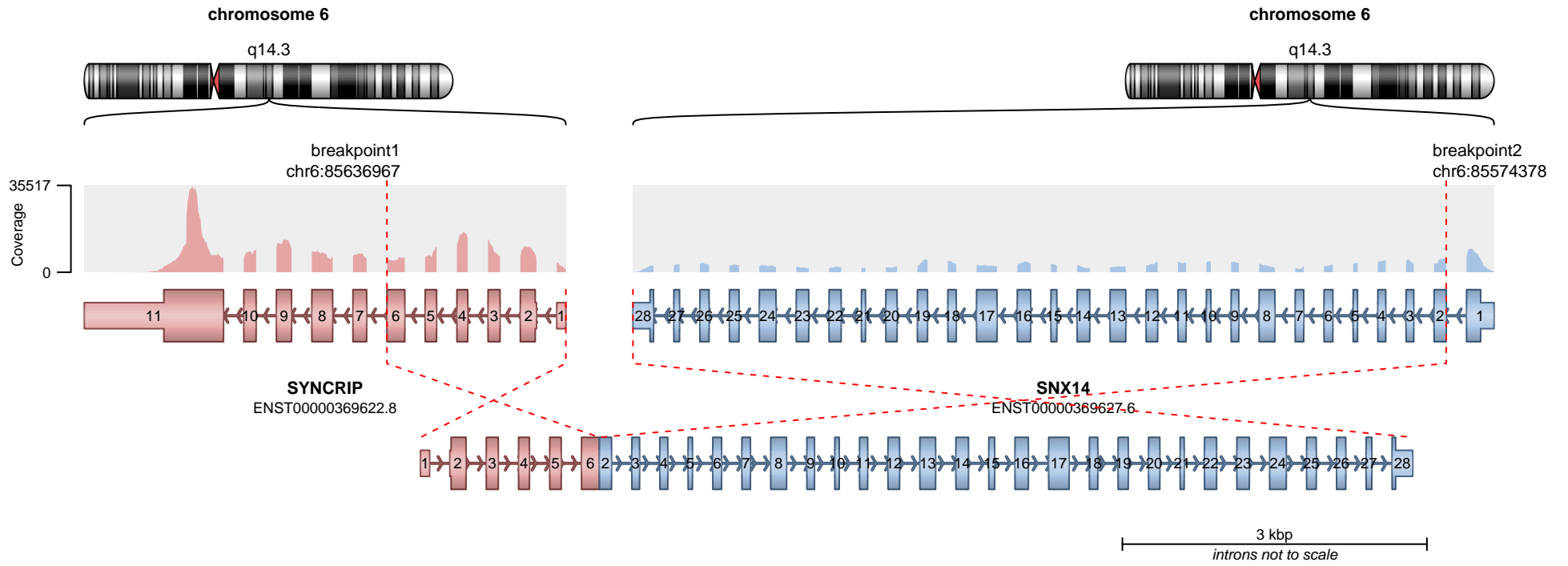

— translocation — deletion
— duplication — inversion

RETAINED PROTEIN DOMAINS
reading frame unclear

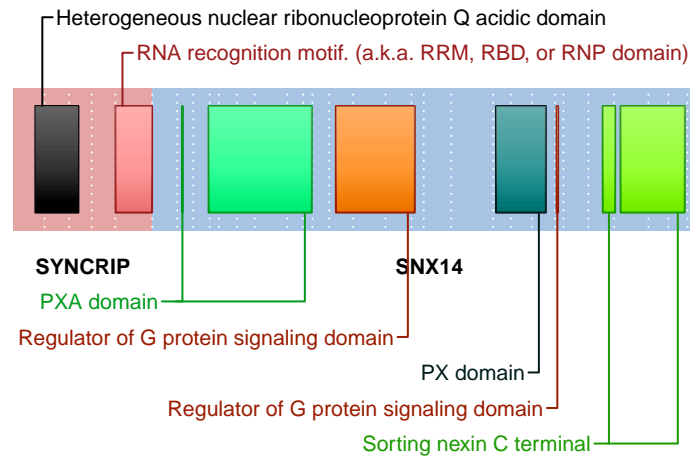

SUPPORTING READ COUNT

Split reads = 146
Discordant mates = 9

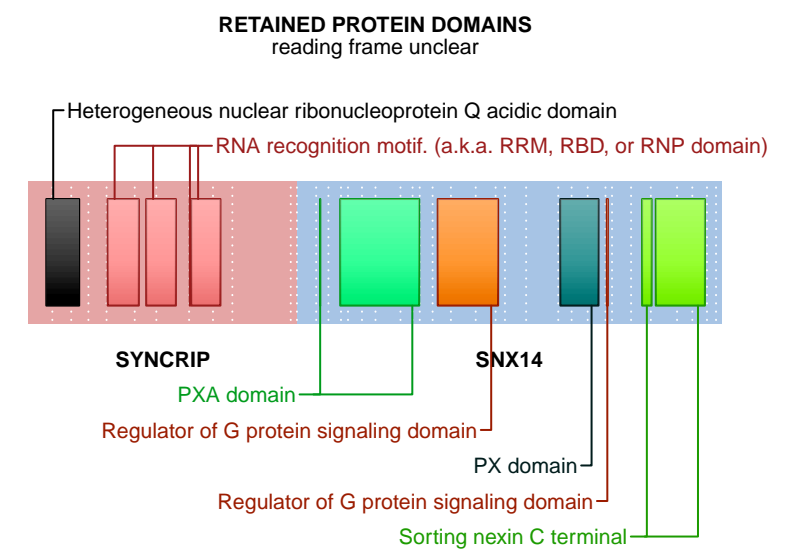
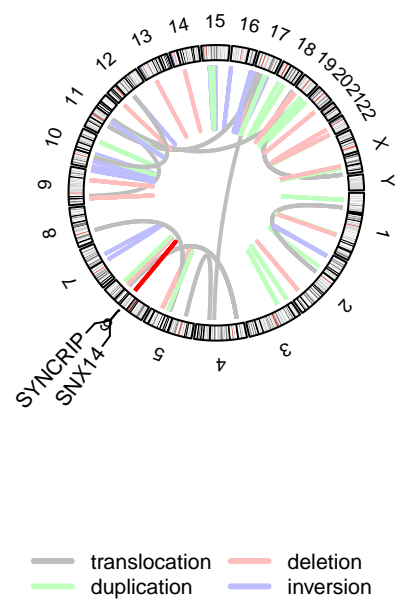
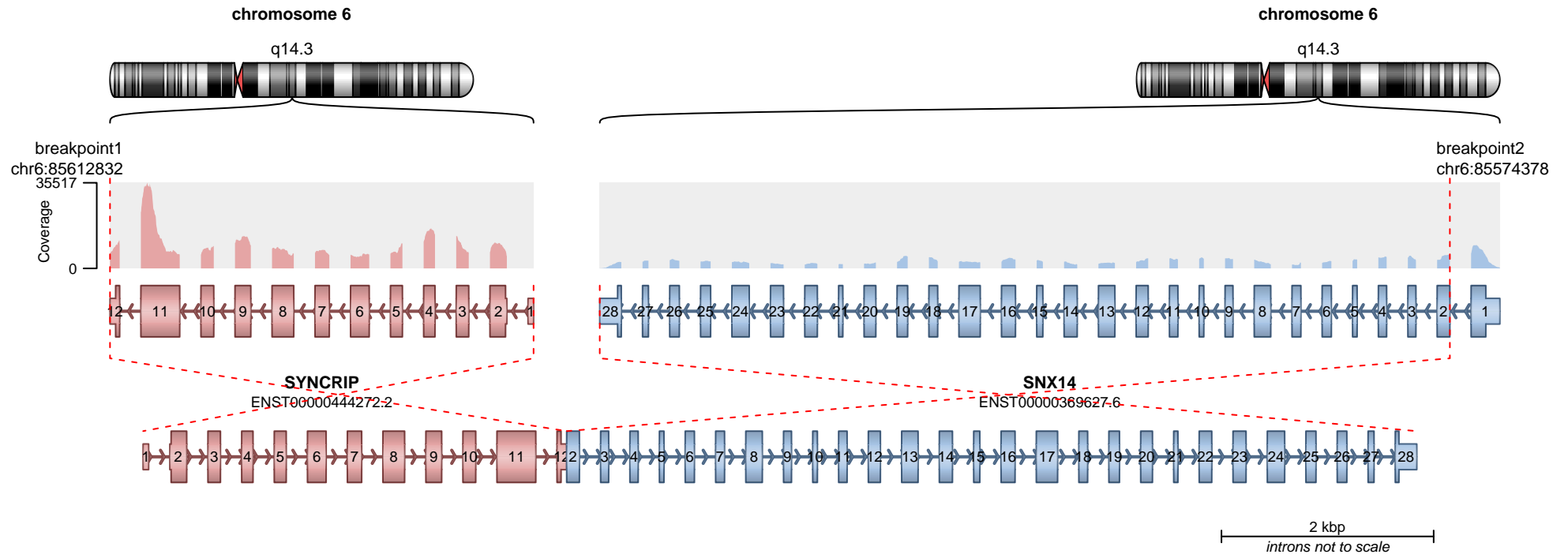

SUPPORTING READ COUNT

Split reads = 72
Discordant mates = 13

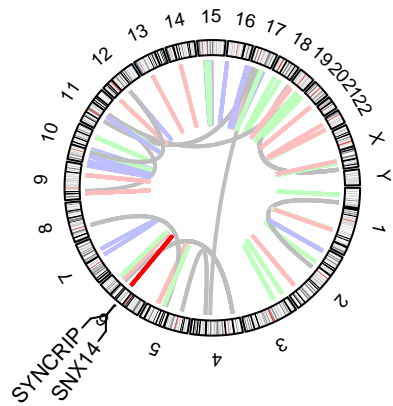
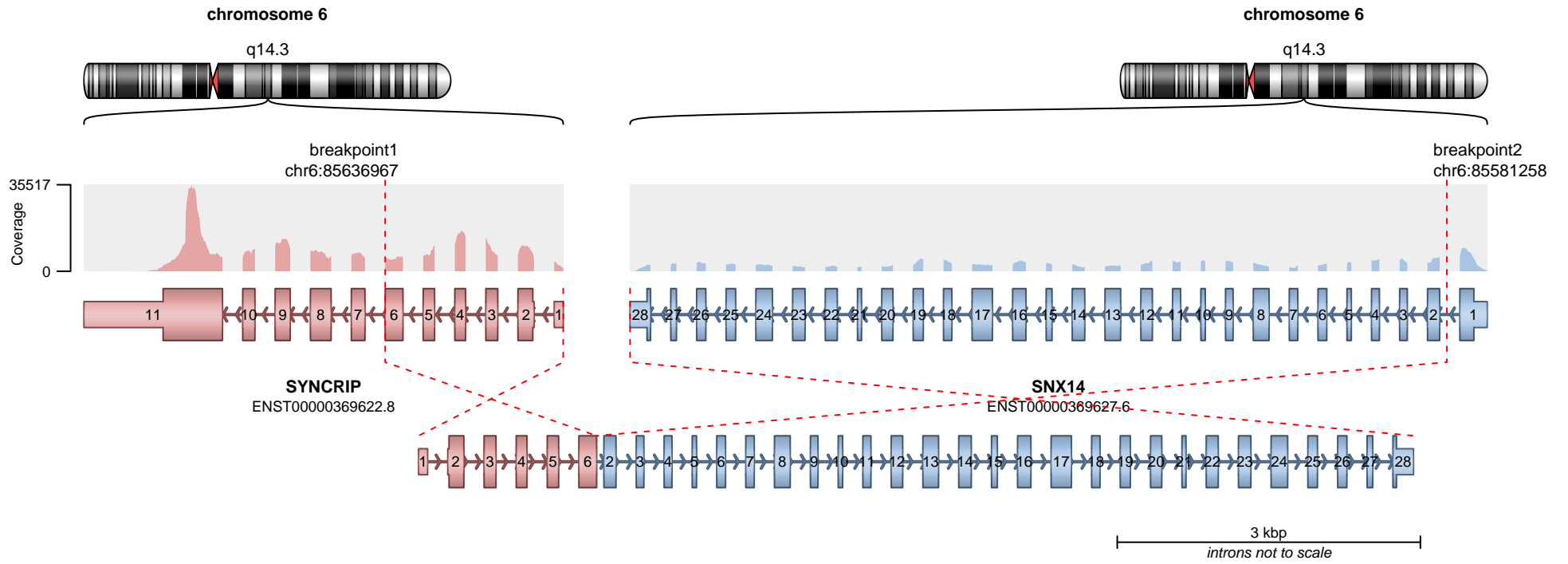

— translocation — deletion
— duplication — inversion

RETAINED PROTEIN DOMAINS
reading frame unclear

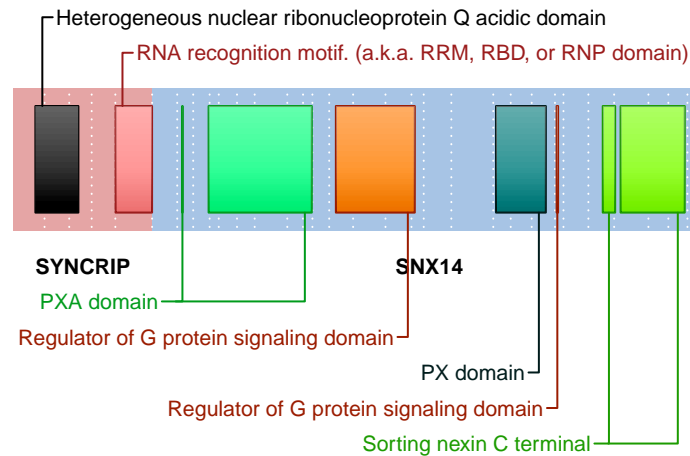

SUPPORTING READ COUNT

Split reads = 4
Discordant mates = 9

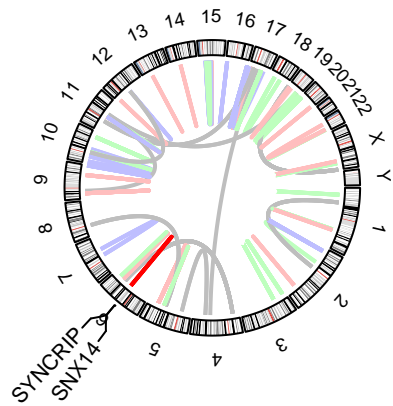
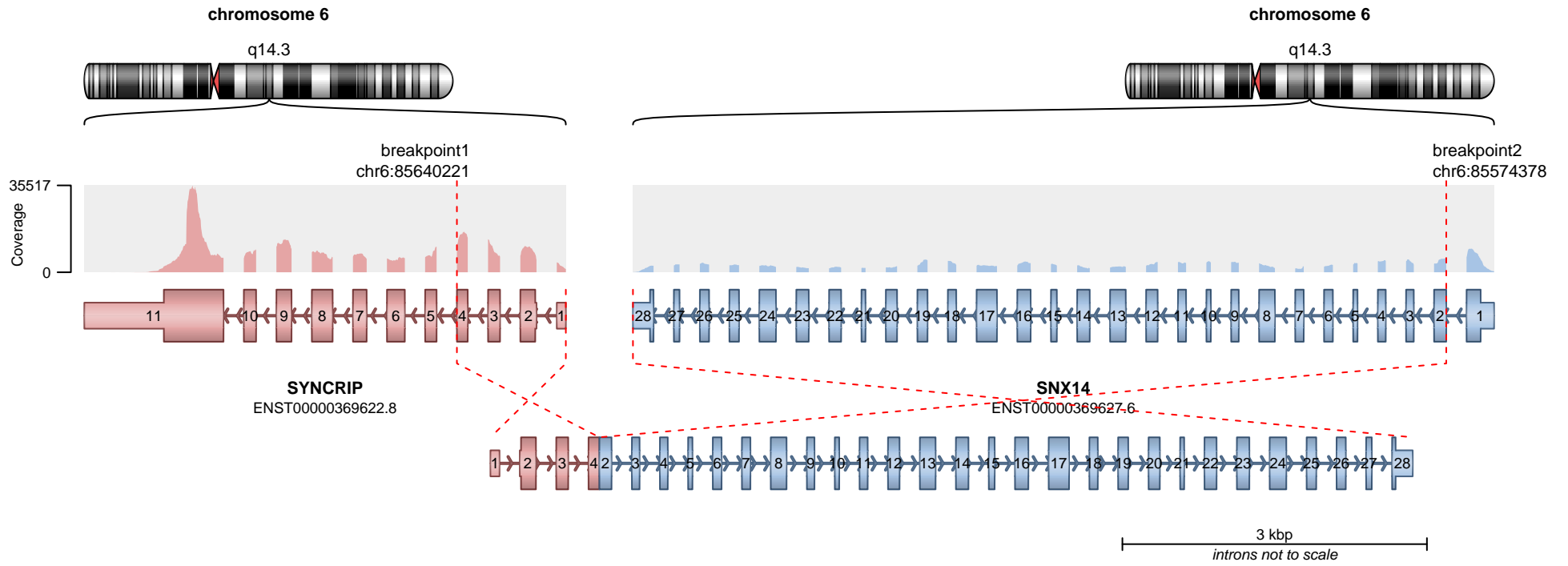

— translocation — deletion
— duplication — inversion

RETAINED PROTEIN DOMAINS
reading frame unclear

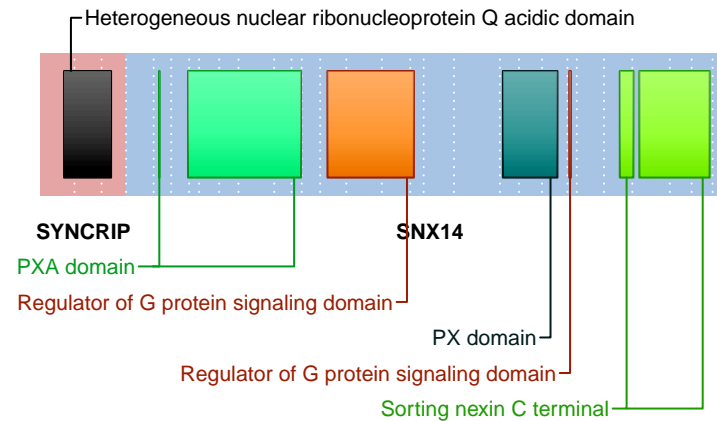

SUPPORTING READ COUNT

Split reads = 4
Discordant mates = 0

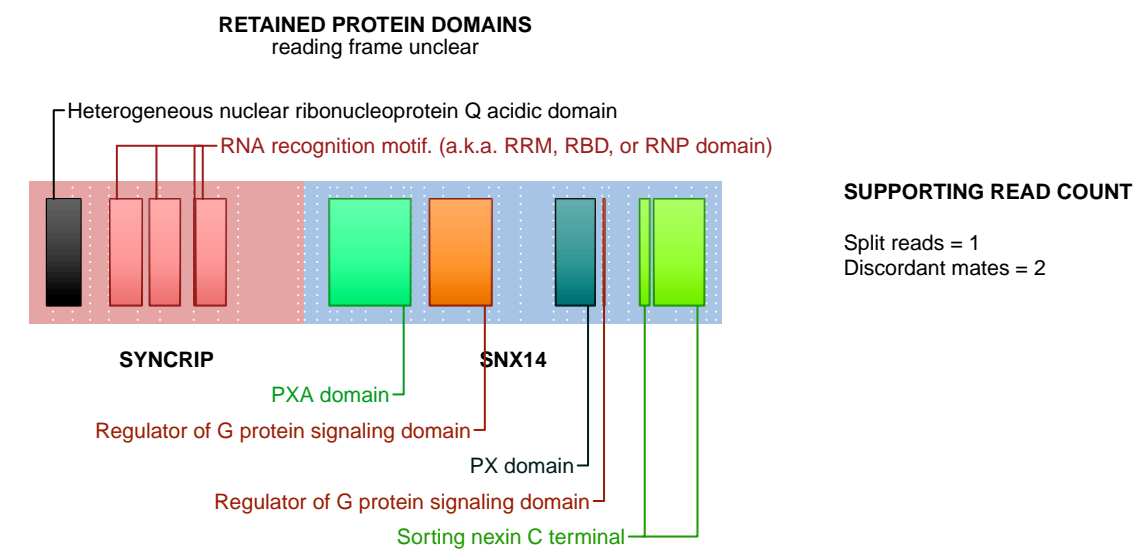
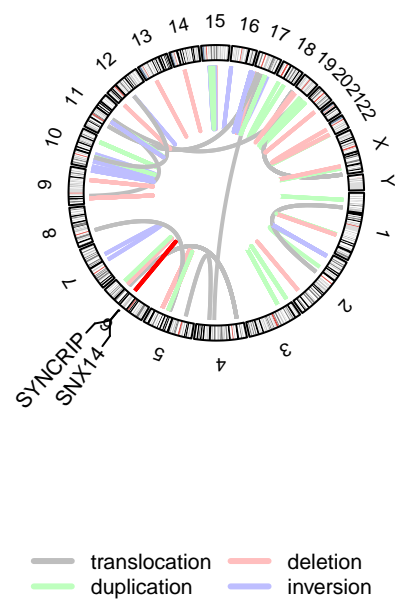
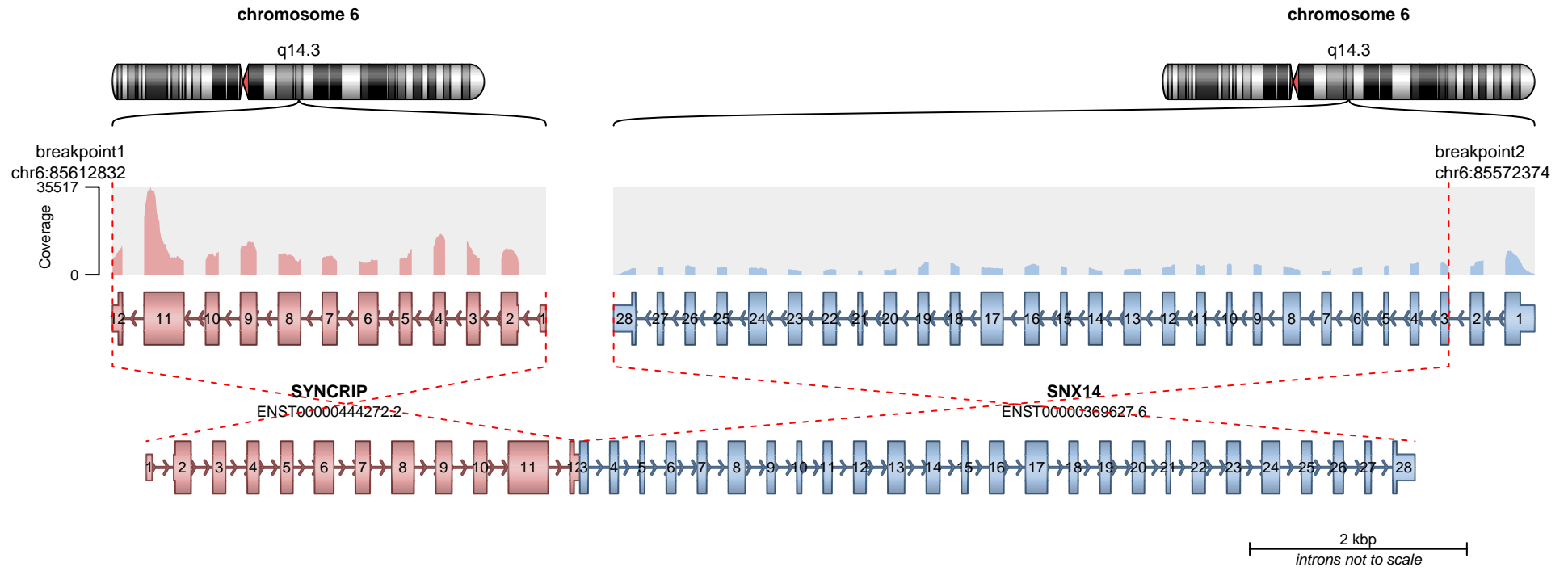

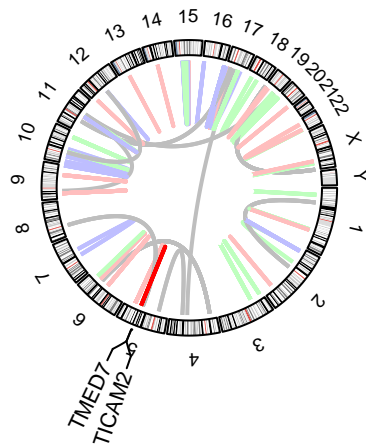
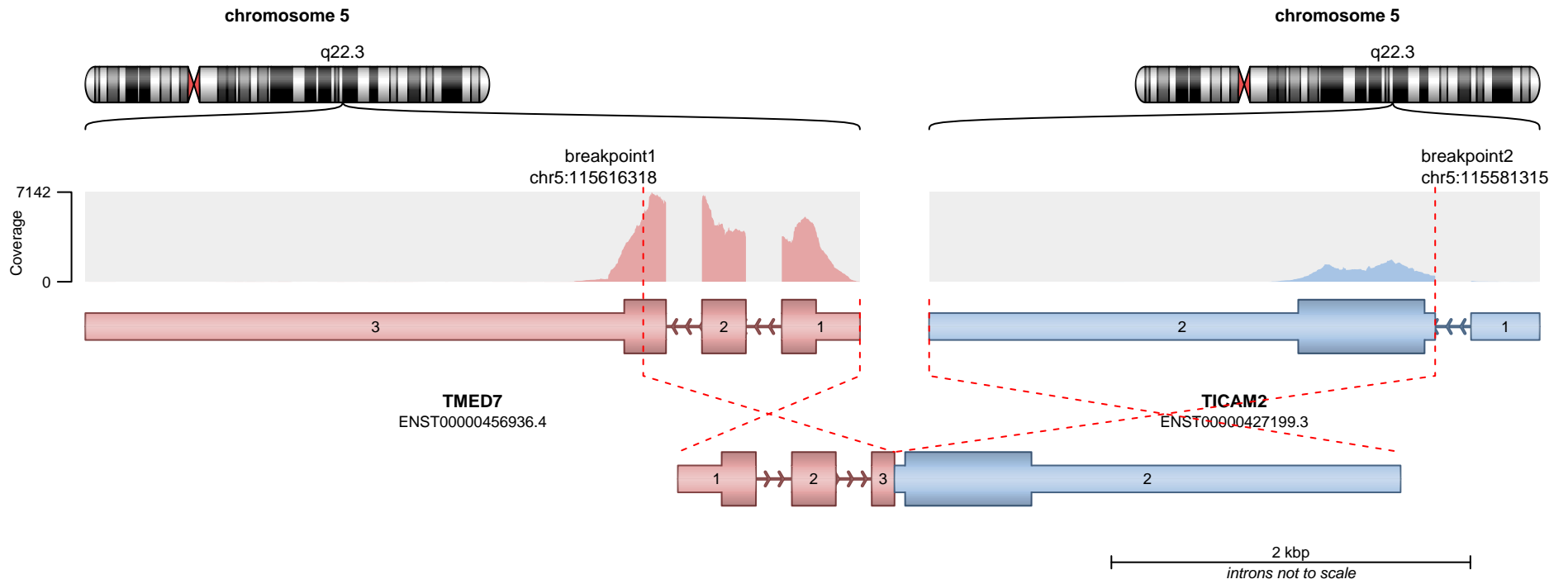

RETAINED PROTEIN DOMAINS
reading frame unclear

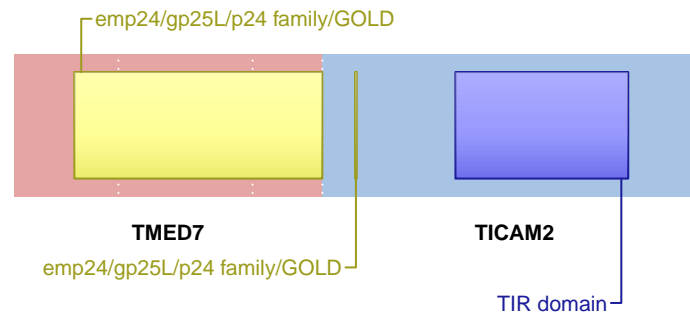

SUPPORTING READ COUNT

Split reads = 138
Discordant mates = 15

— translocation — deletion
— duplication — inversion

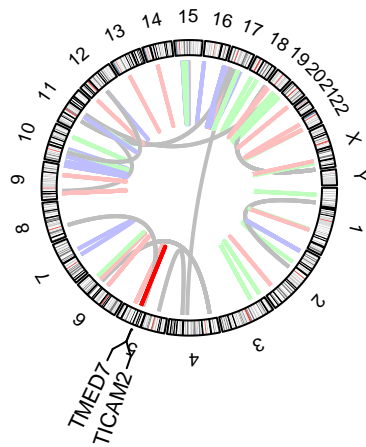
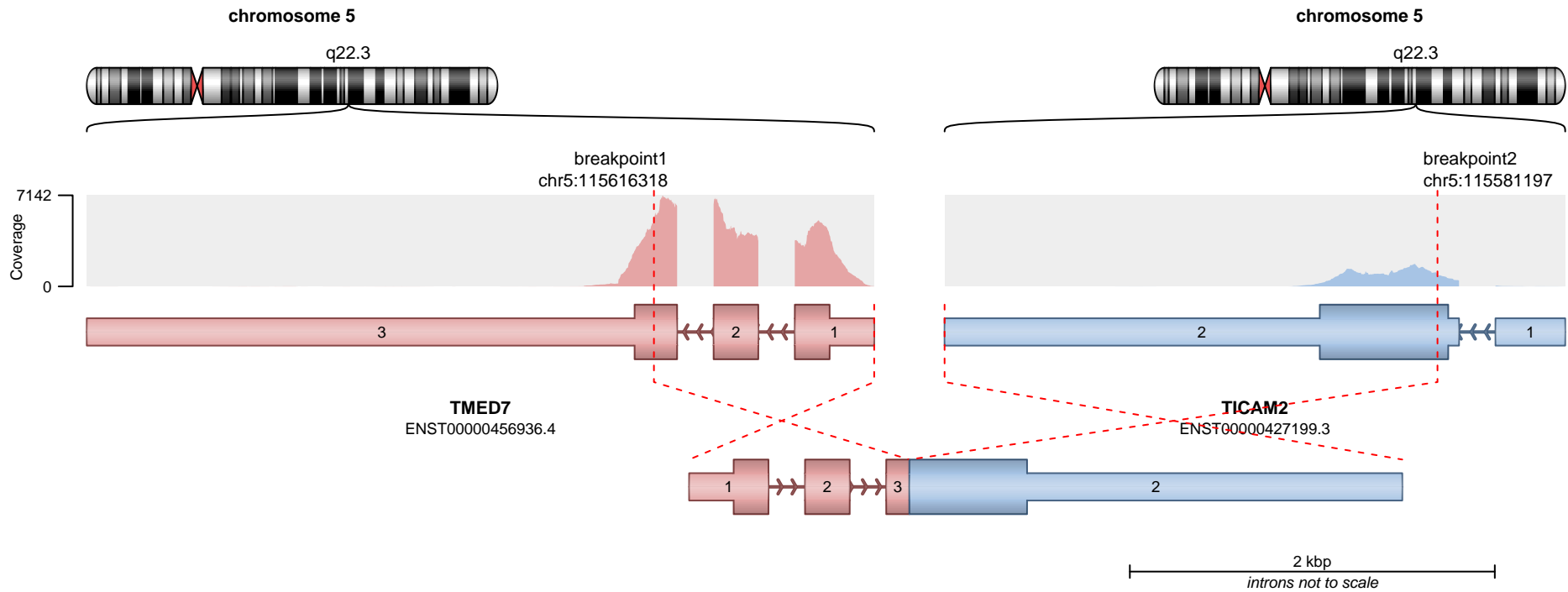

RETAINED PROTEIN DOMAINS
reading frame unclear

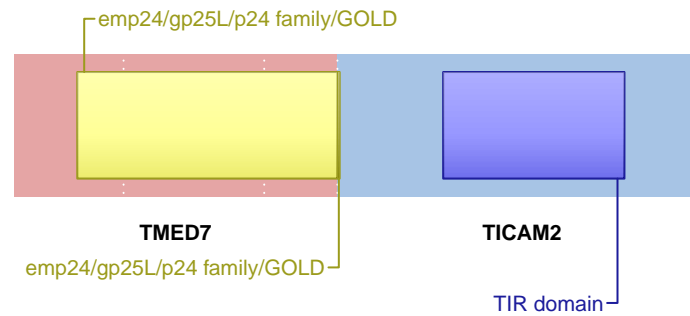

SUPPORTING READ COUNT

Split reads = 26
Discordant mates = 5

— translocation — deletion
— duplication — inversion

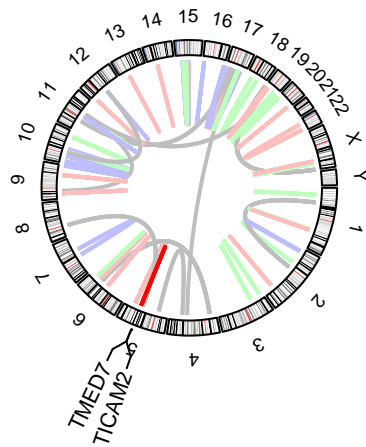
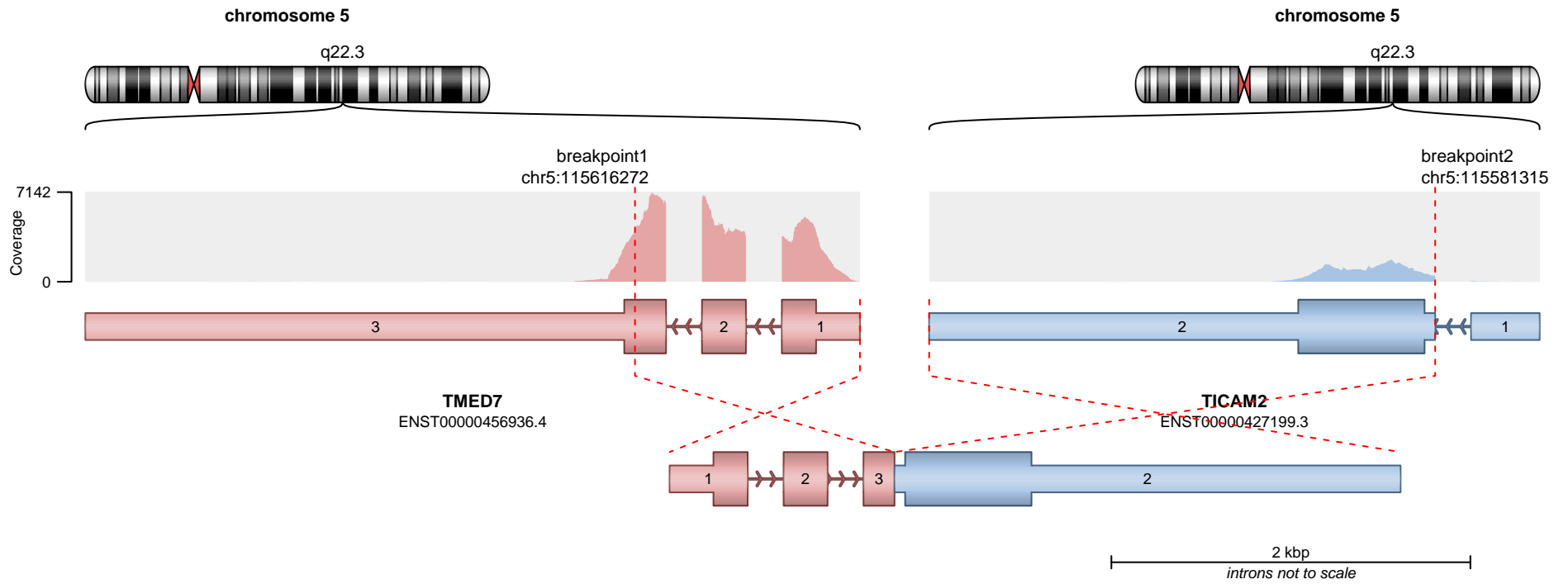

RETAINED PROTEIN DOMAINS
reading frame unclear

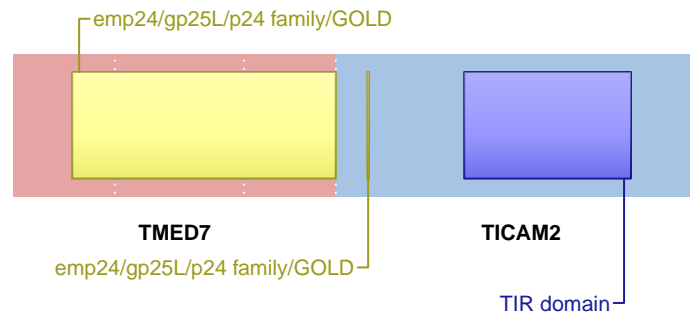

SUPPORTING READ COUNT

Split reads = 3
Discordant mates = 15

— translocation — deletion
— duplication — inversion

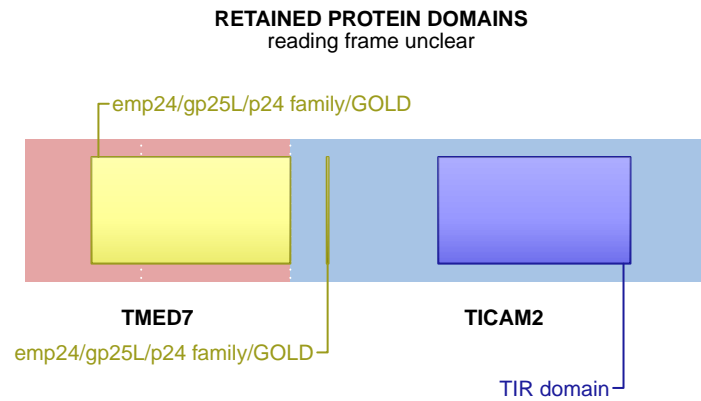
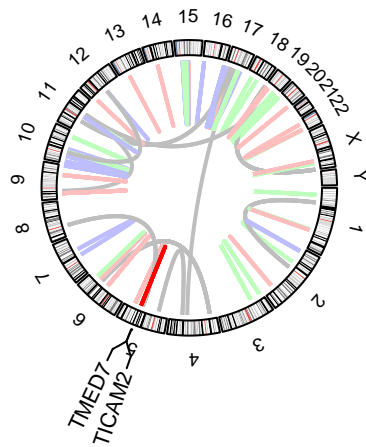
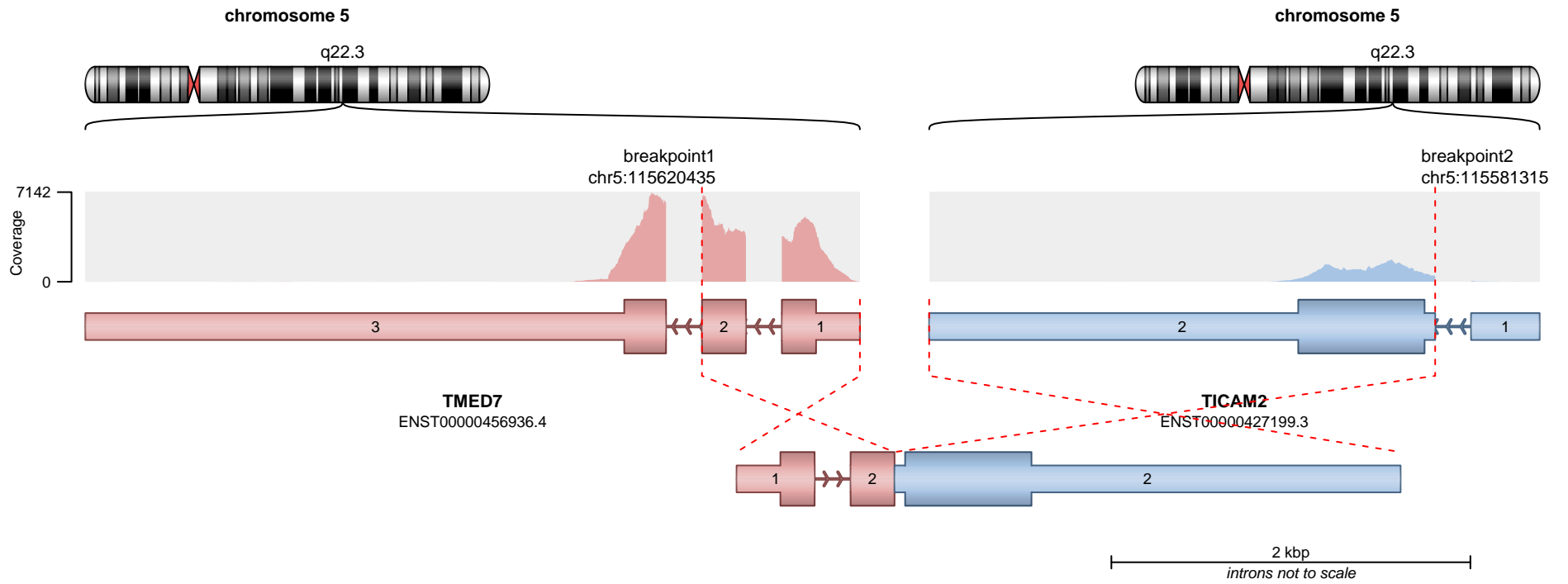

SUPPORTING READ COUNT

Split reads = 3
Discordant mates = 3

— translocation — deletion
— duplication — inversion

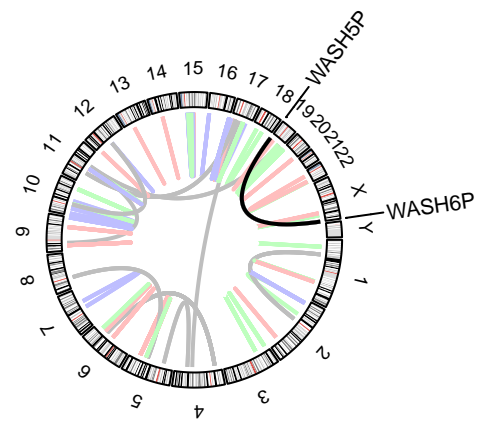
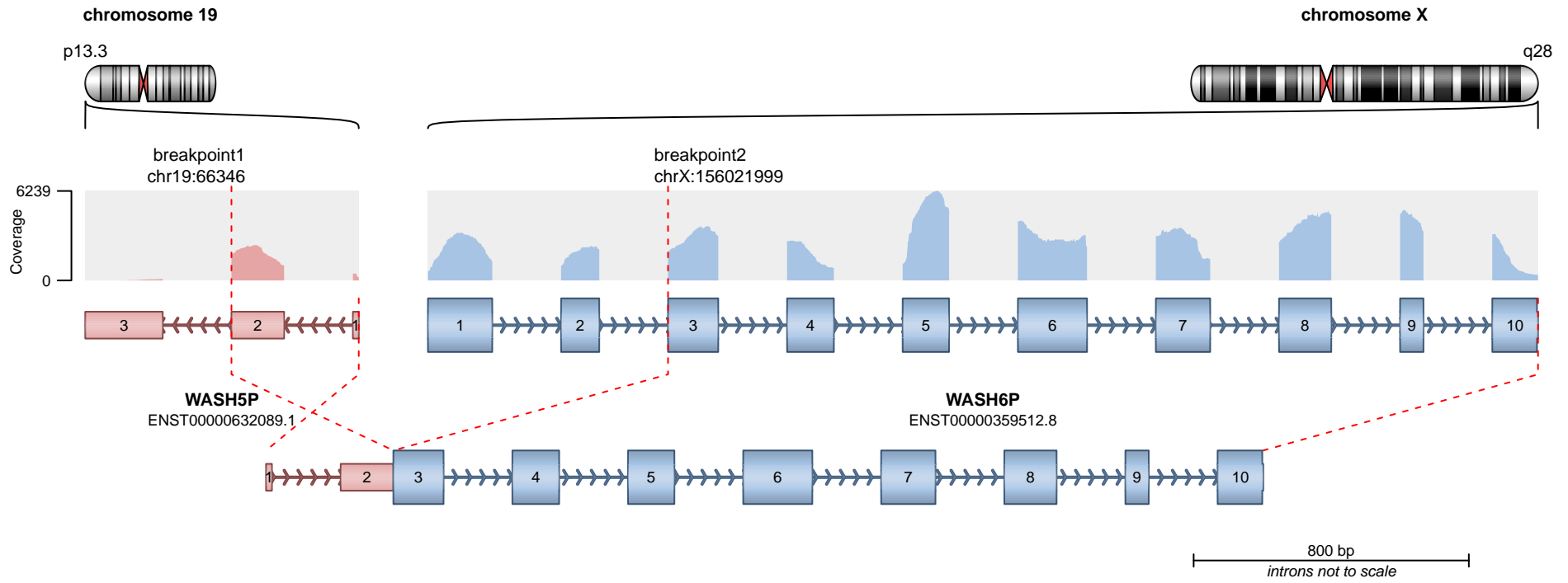

RETAINED PROTEIN DOMAINS
reading frame unclear

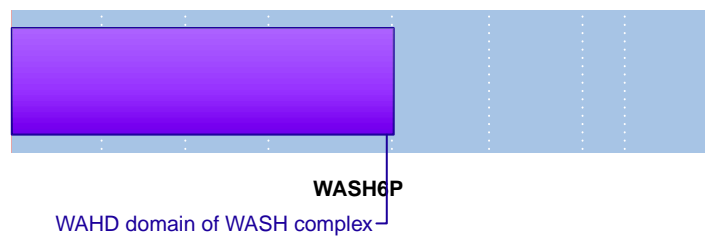

SUPPORTING READ COUNT

Split reads = 130
Discordant mates = 41

- translocation
- duplication
- deletion
- inversion

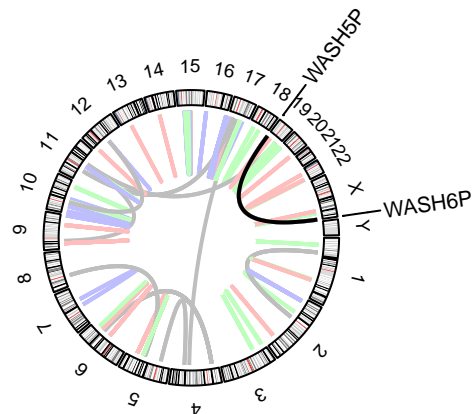
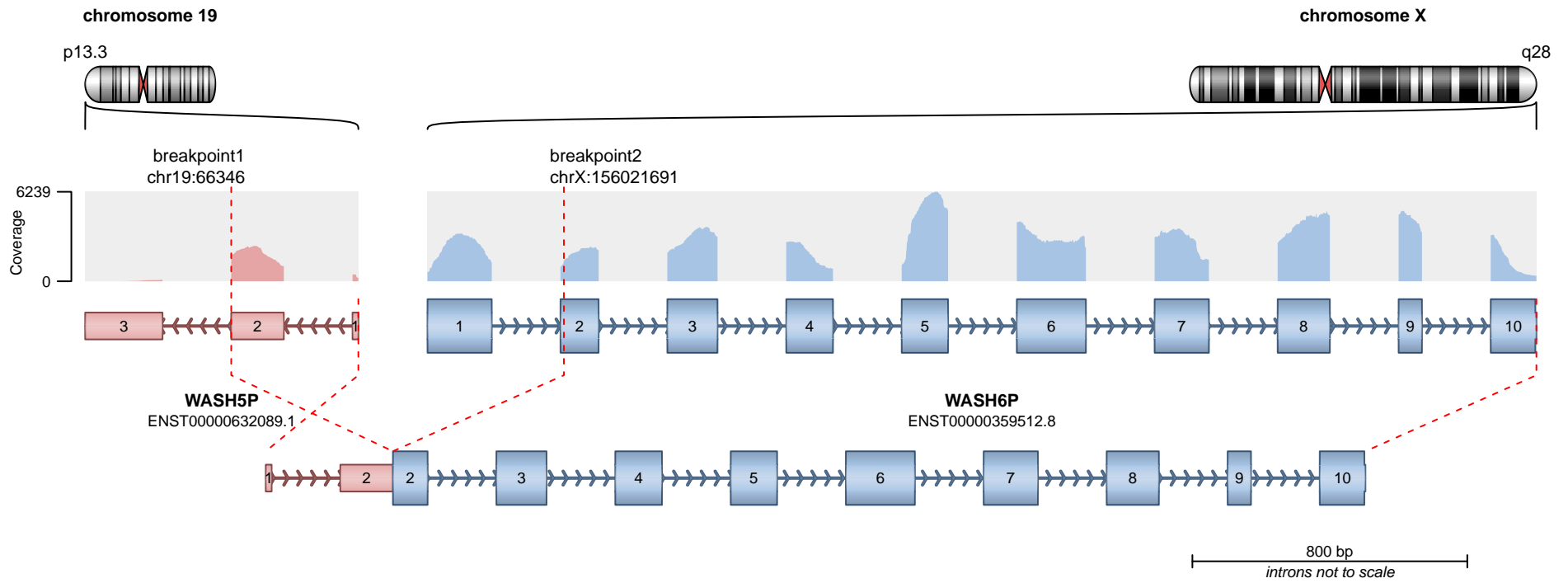

RETAINED PROTEIN DOMAINS
reading frame unclear

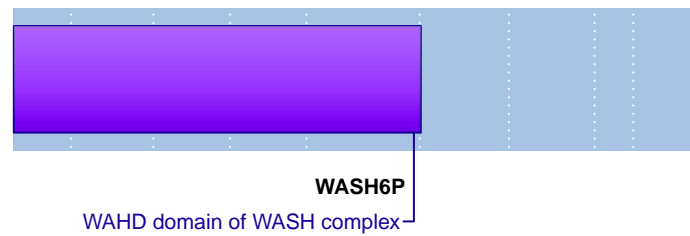

SUPPORTING READ COUNT

Split reads = 40
Discordant mates = 59

— translocation — deletion
— duplication — inversion

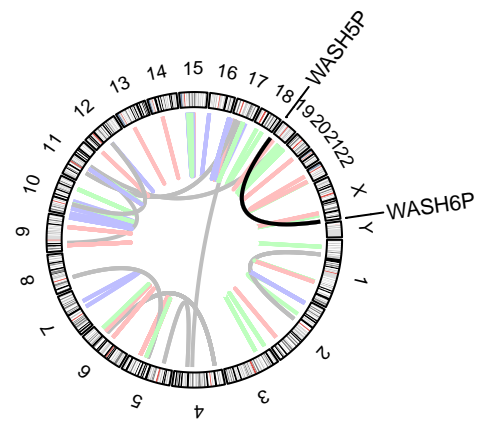
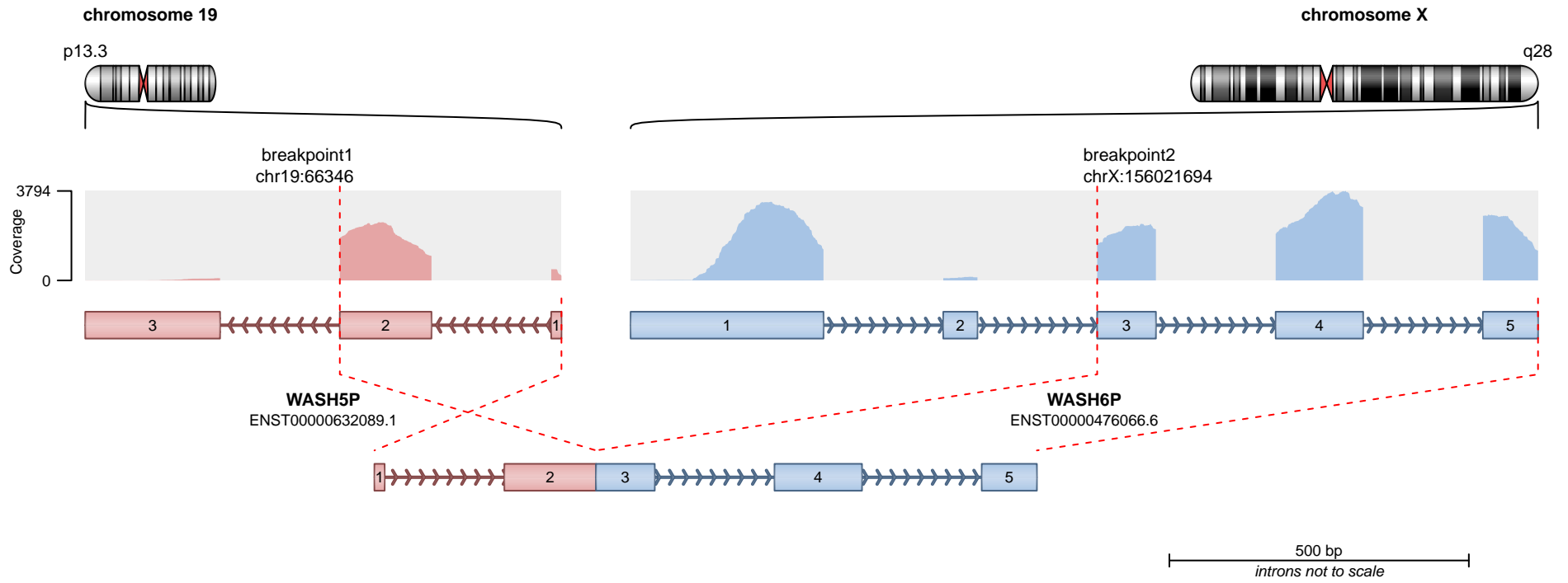

— translocation — deletion
— duplication — inversion

Genes are not protein-coding.

SUPPORTING READ COUNT

Split reads = 29
Discordant mates = 59

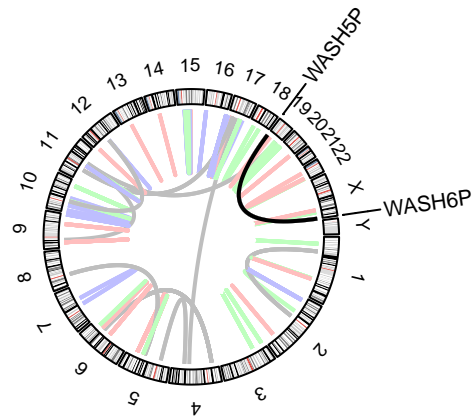
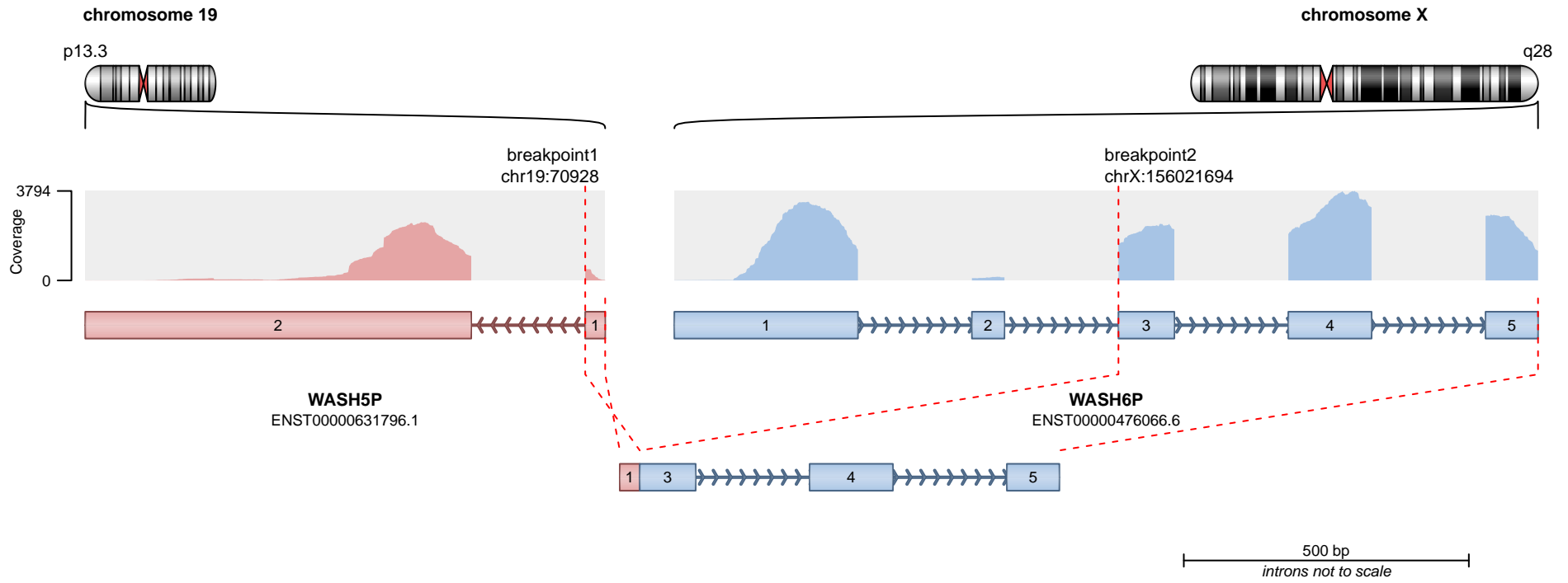

— translocation — deletion
— duplication — inversion

Genes are not protein-coding.

SUPPORTING READ COUNT

Split reads = 30
Discordant mates = 0

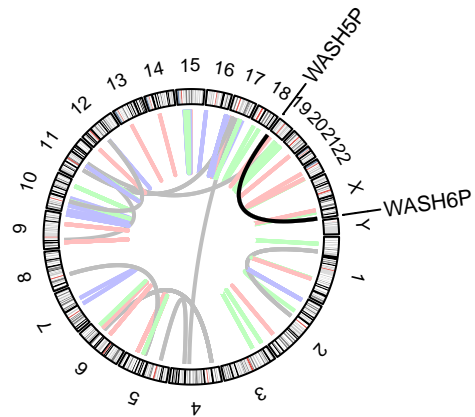
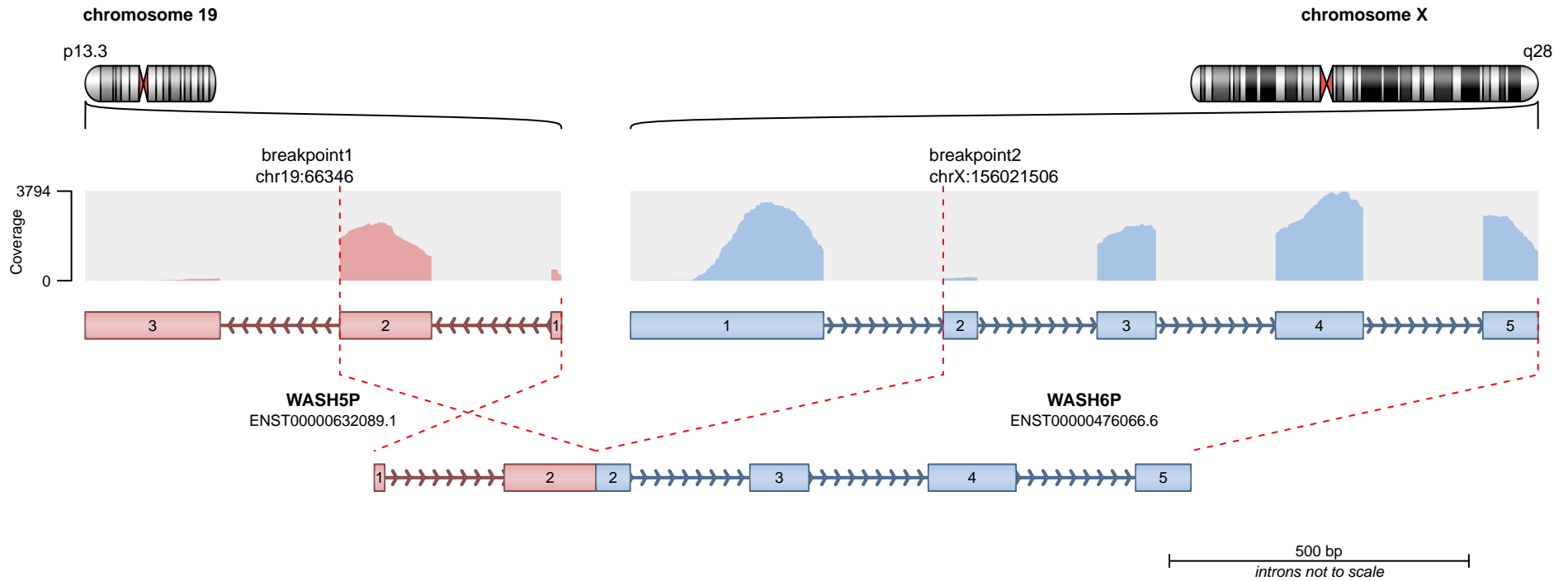

— translocation — deletion
— duplication — inversion

Genes are not protein-coding.

SUPPORTING READ COUNT

Split reads = 11
Discordant mates = 60

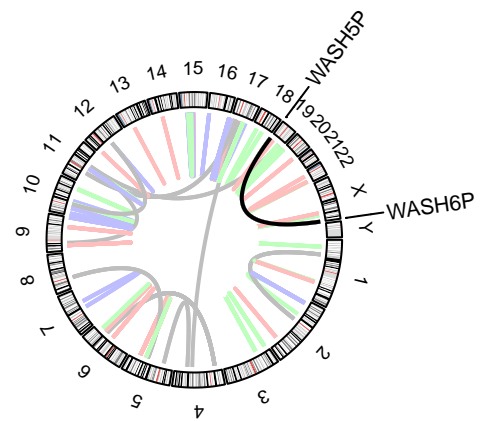
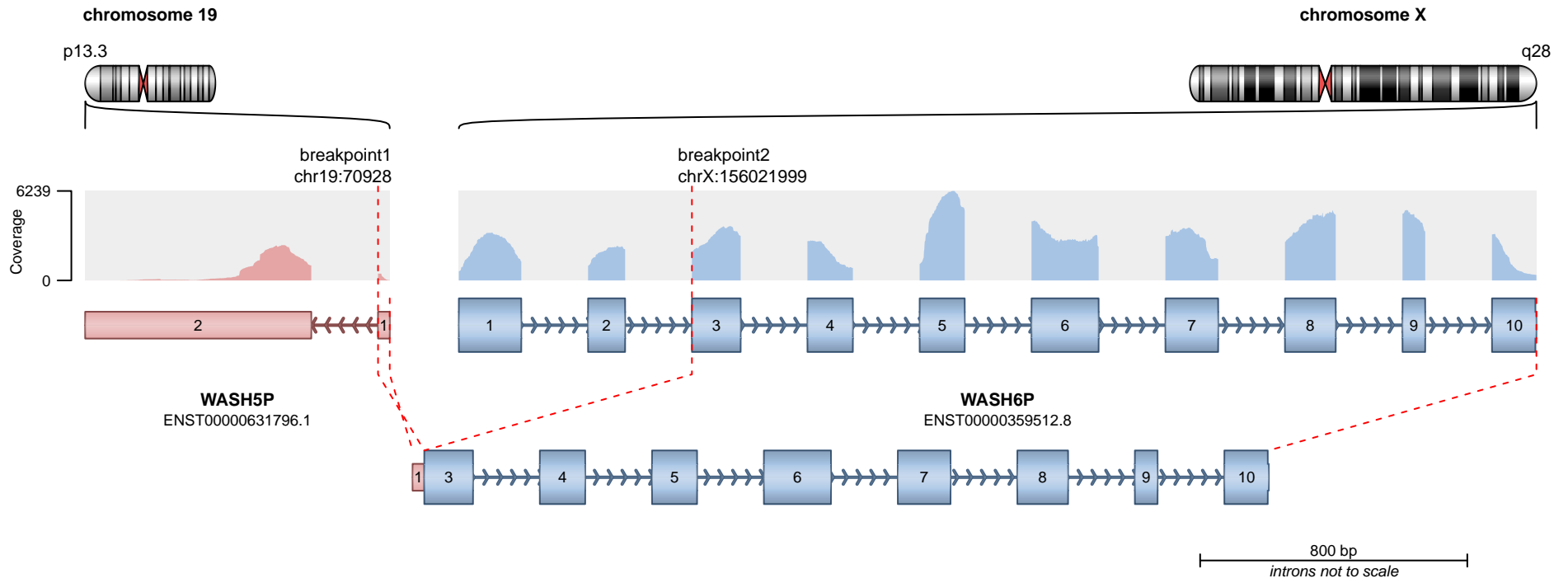

RETAINED PROTEIN DOMAINS
reading frame unclear

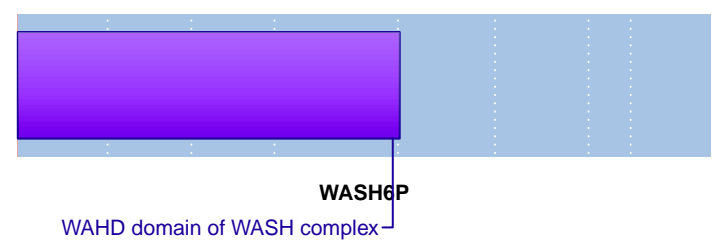

SUPPORTING READ COUNT

Split reads = 25
Discordant mates = 0

- translocation
- duplication
- deletion
- inversion

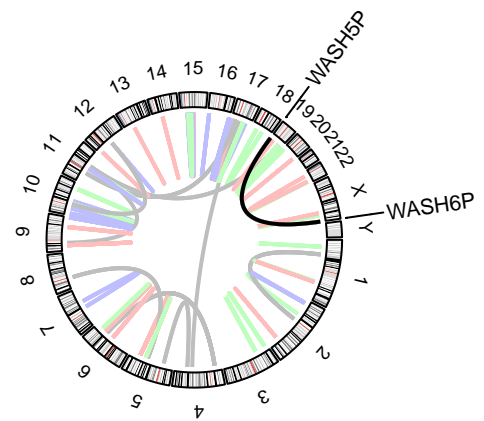
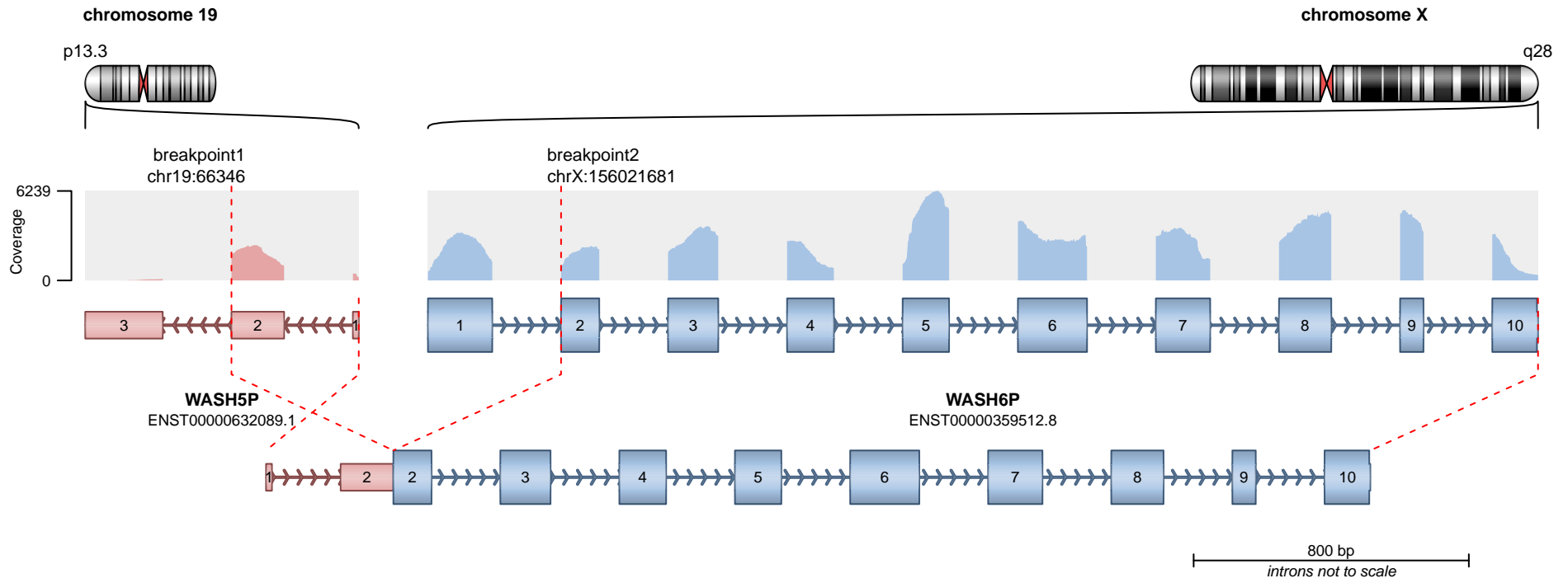

RETAINED PROTEIN DOMAINS
reading frame unclear

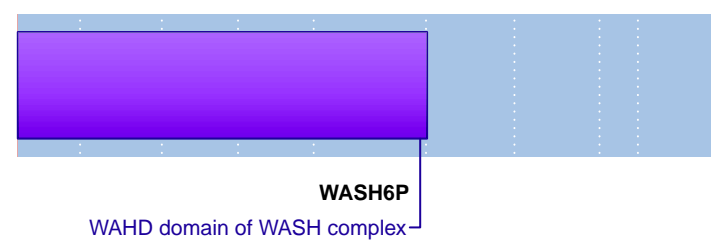

SUPPORTING READ COUNT

Split reads = 6
Discordant mates = 59

— translocation — deletion
— duplication — inversion

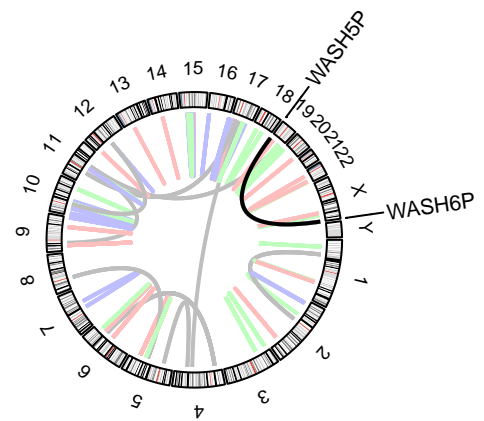
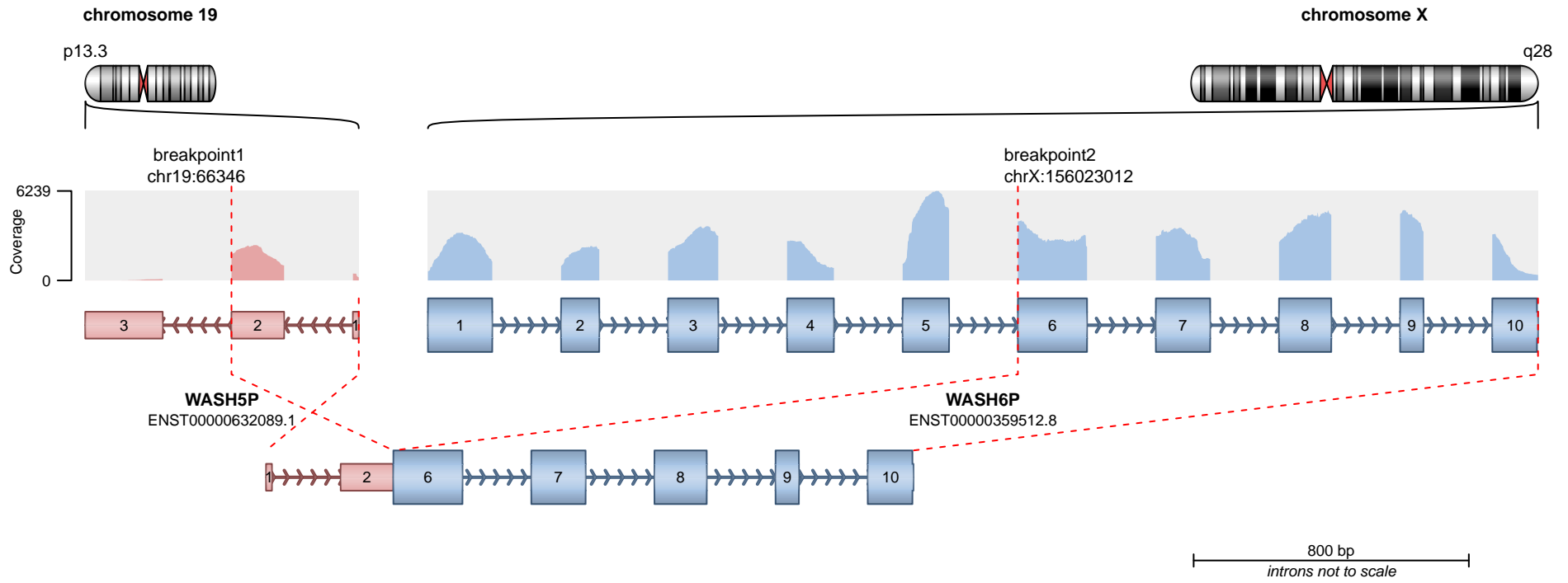

RETAINED PROTEIN DOMAINS
reading frame unclear

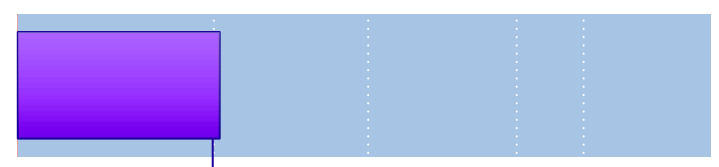

SUPPORTING READ COUNT

Split reads = 1
Discordant mates = 1

- translocation
- duplication
- deletion
- inversion

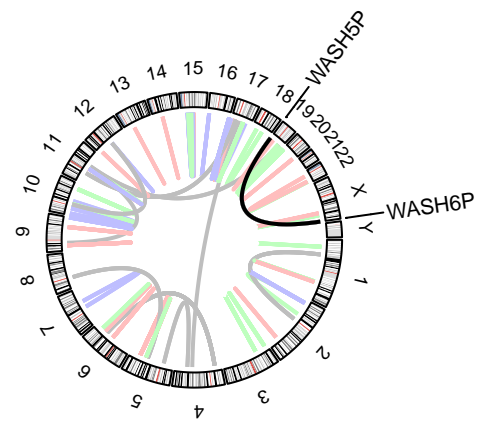
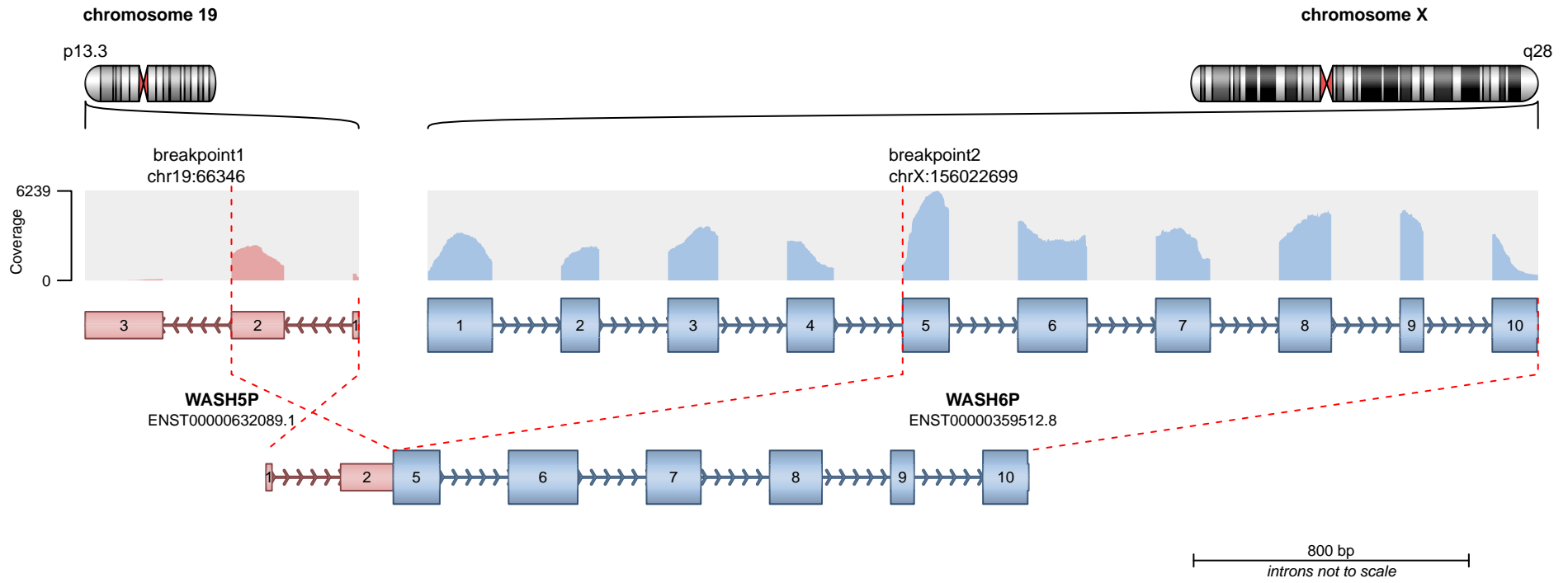

RETAINED PROTEIN DOMAINS
reading frame unclear

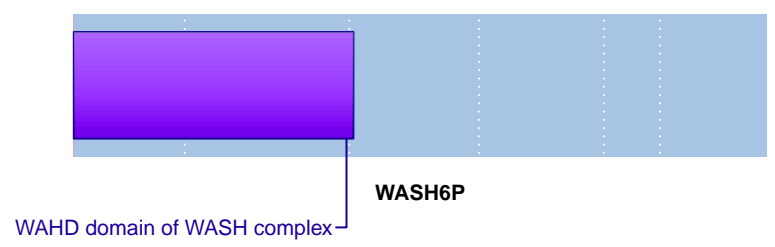

SUPPORTING READ COUNT

Split reads = 1
Discordant mates = 1

— translocation — deletion
— duplication — inversion

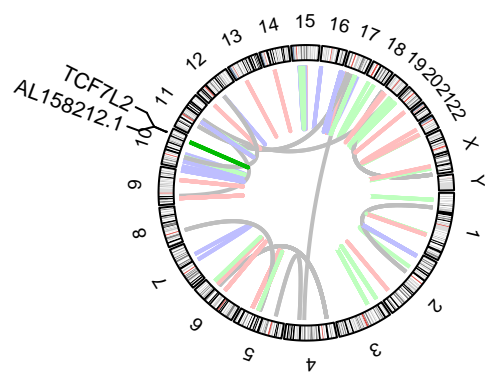
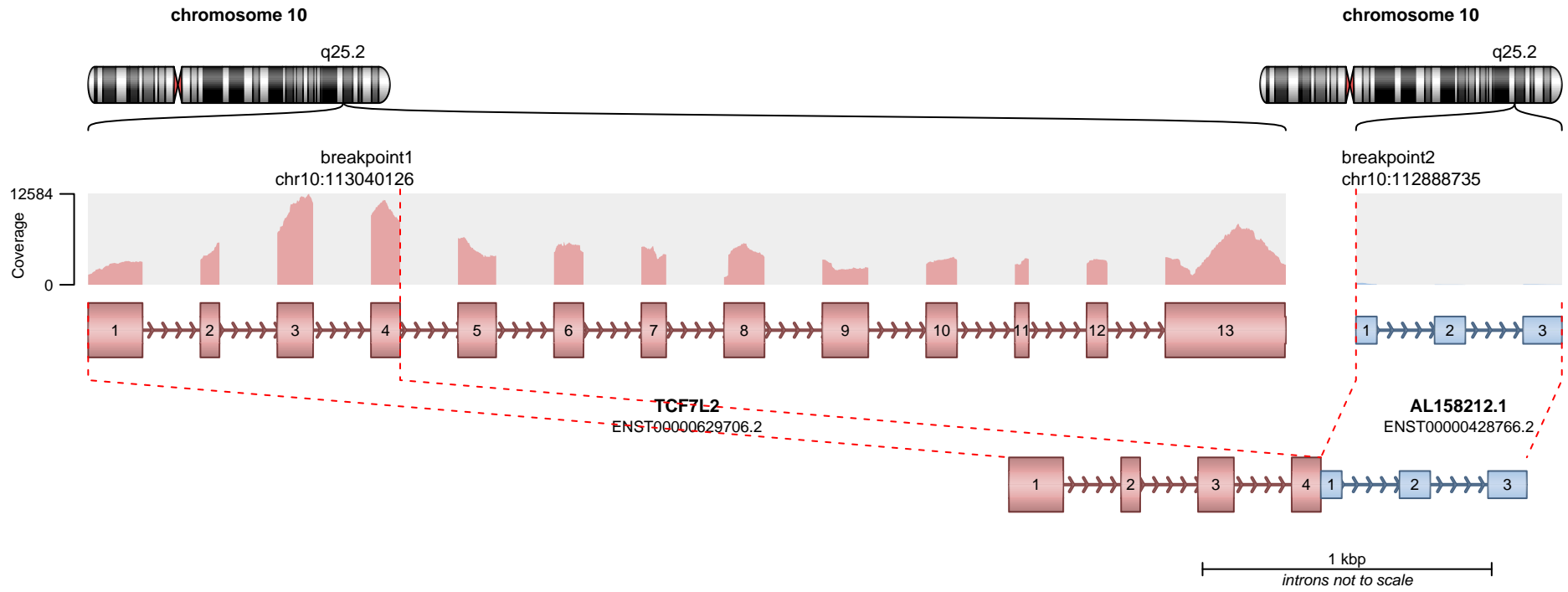

RETAINED PROTEIN DOMAINS
reading frame unclear

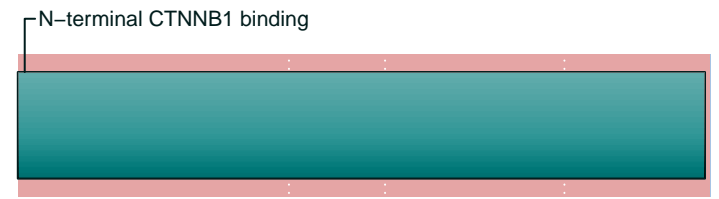

SUPPORTING READ COUNT

Split reads = 117
Discordant mates = 12

- translocation
- duplication
- deletion
- inversion

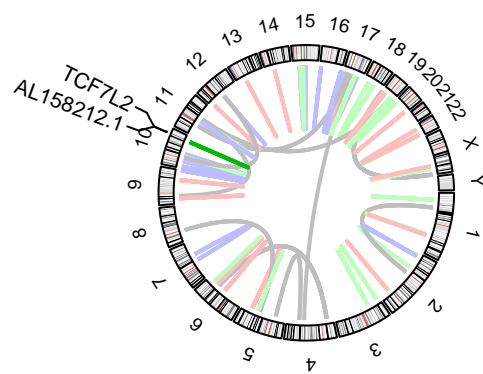
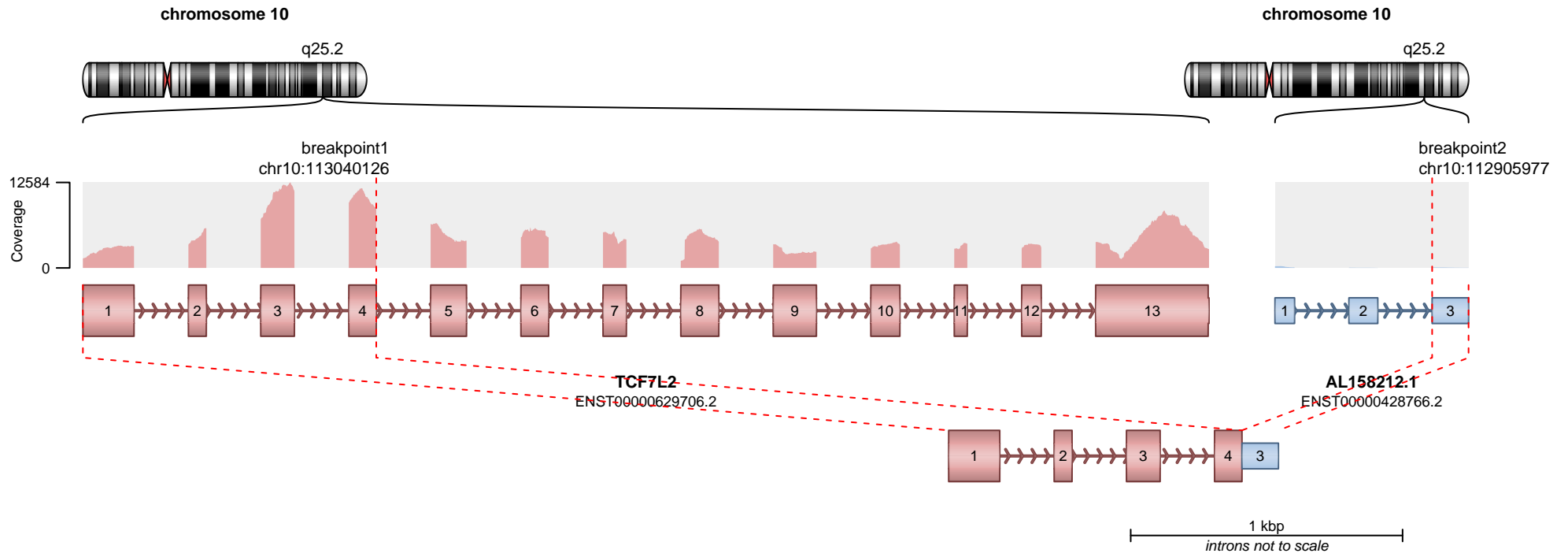

RETAINED PROTEIN DOMAINS
reading frame unclear

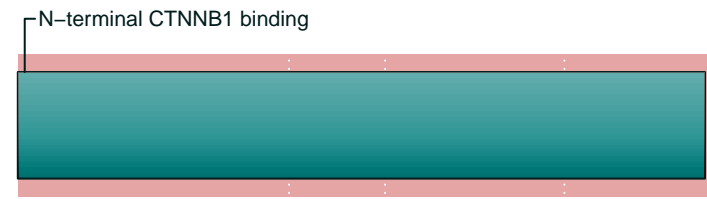

SUPPORTING READ COUNT

Split reads = 25
Discordant mates = 4

- translocation
- duplication
- deletion
- inversion

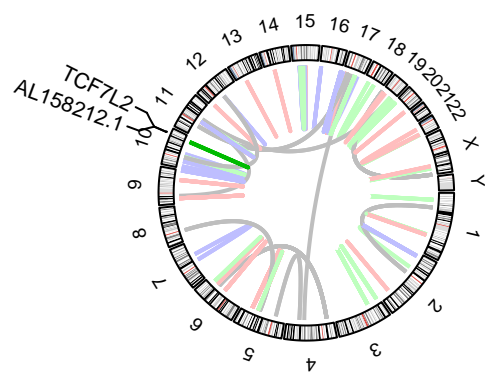
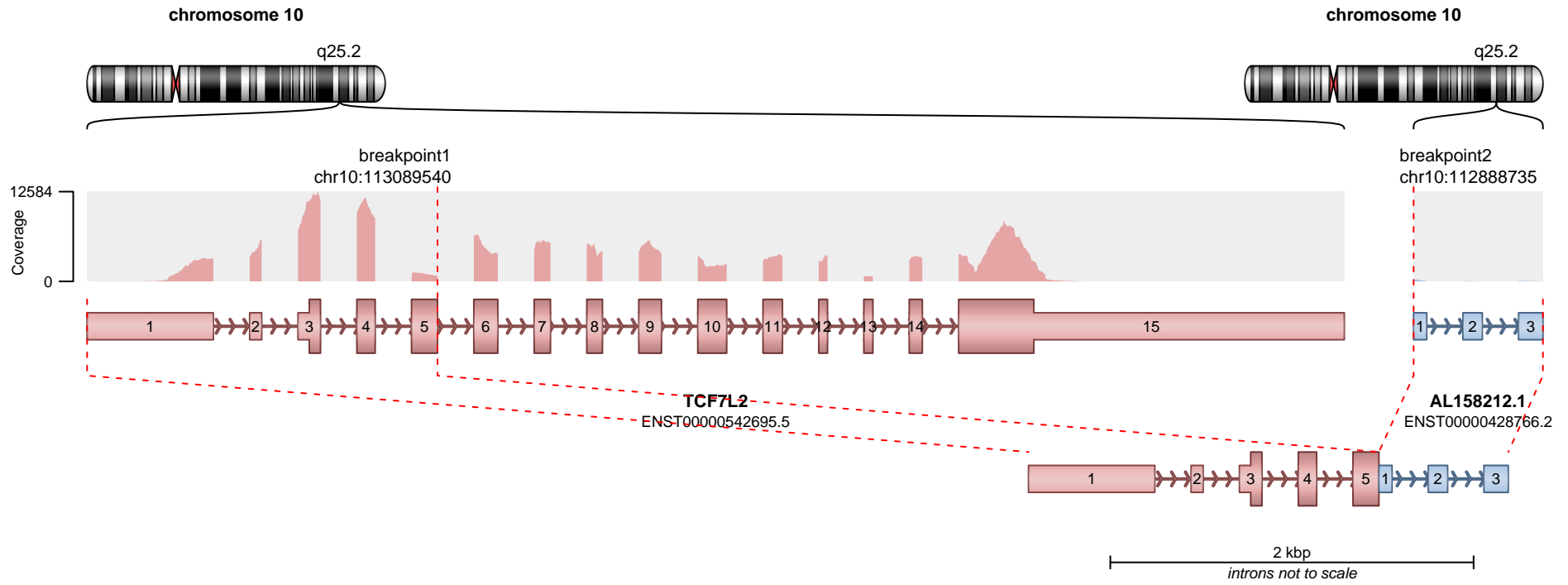

RETAINED PROTEIN DOMAINS
reading frame unclear

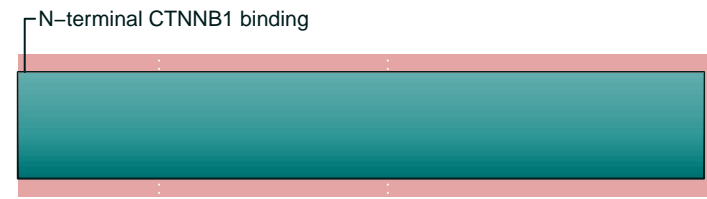

TCF7L2

SUPPORTING READ COUNT

Split reads = 17
Discordant mates = 12

- translocation
- duplication
- deletion
- inversion

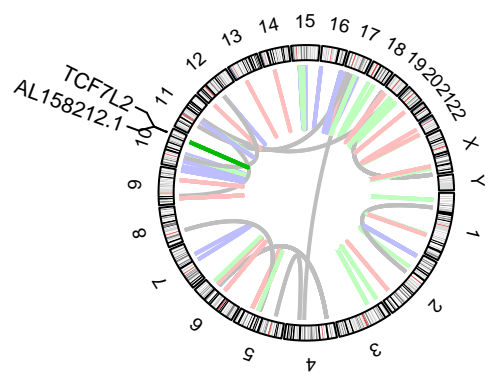
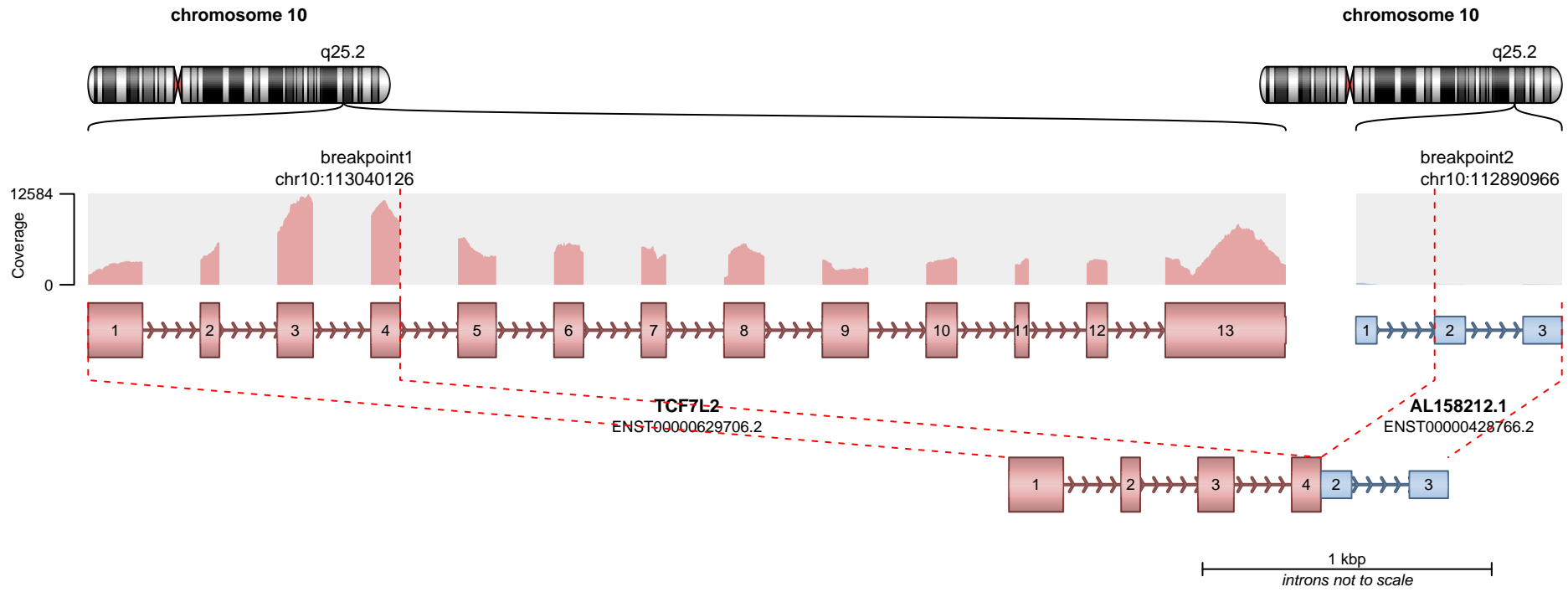

RETAINED PROTEIN DOMAINS
reading frame unclear

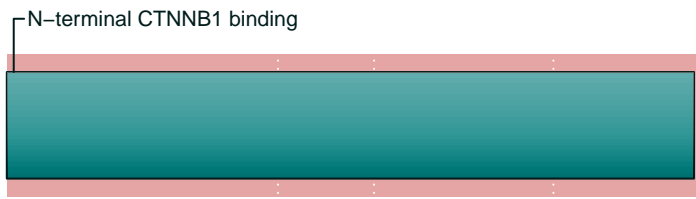

SUPPORTING READ COUNT

Split reads = 3
Discordant mates = 7

- translocation
- duplication
- deletion
- inversion

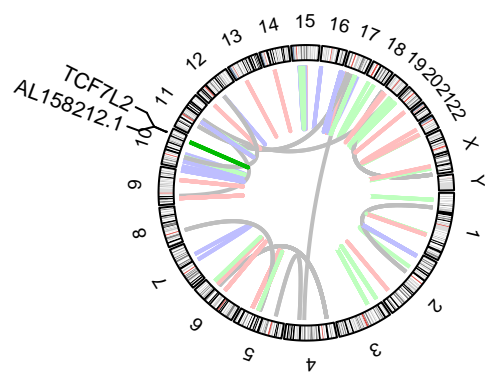
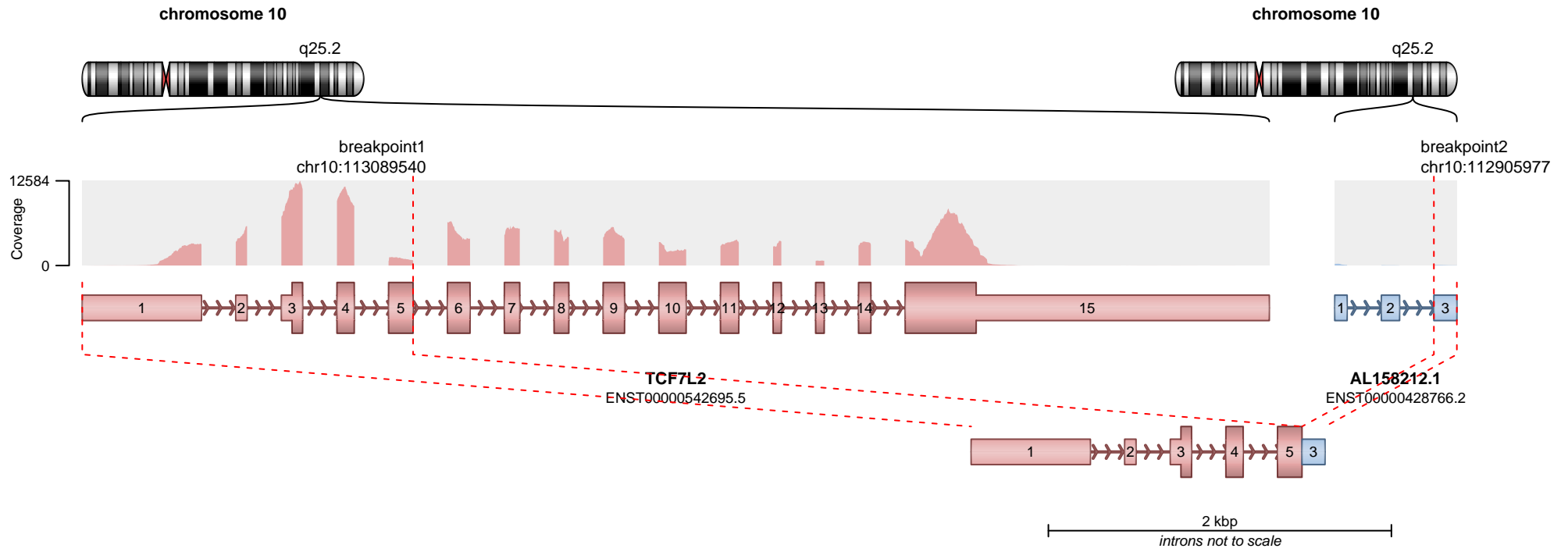

RETAINED PROTEIN DOMAINS
reading frame unclear

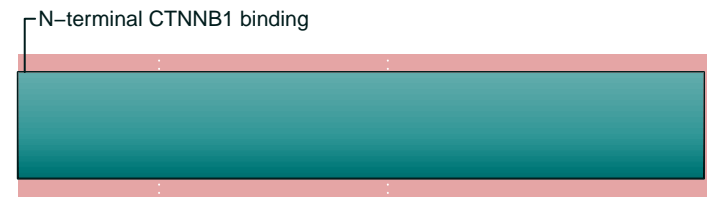

SUPPORTING READ COUNT

Split reads = 1
Discordant mates = 4

- translocation
- duplication
- deletion
- inversion

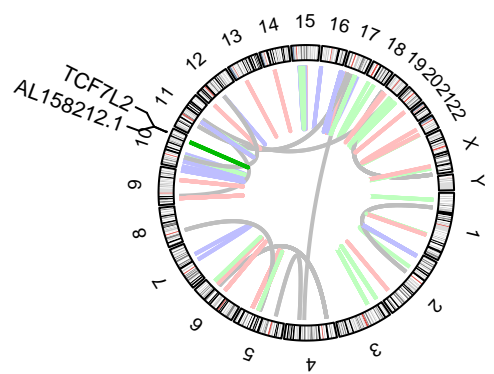
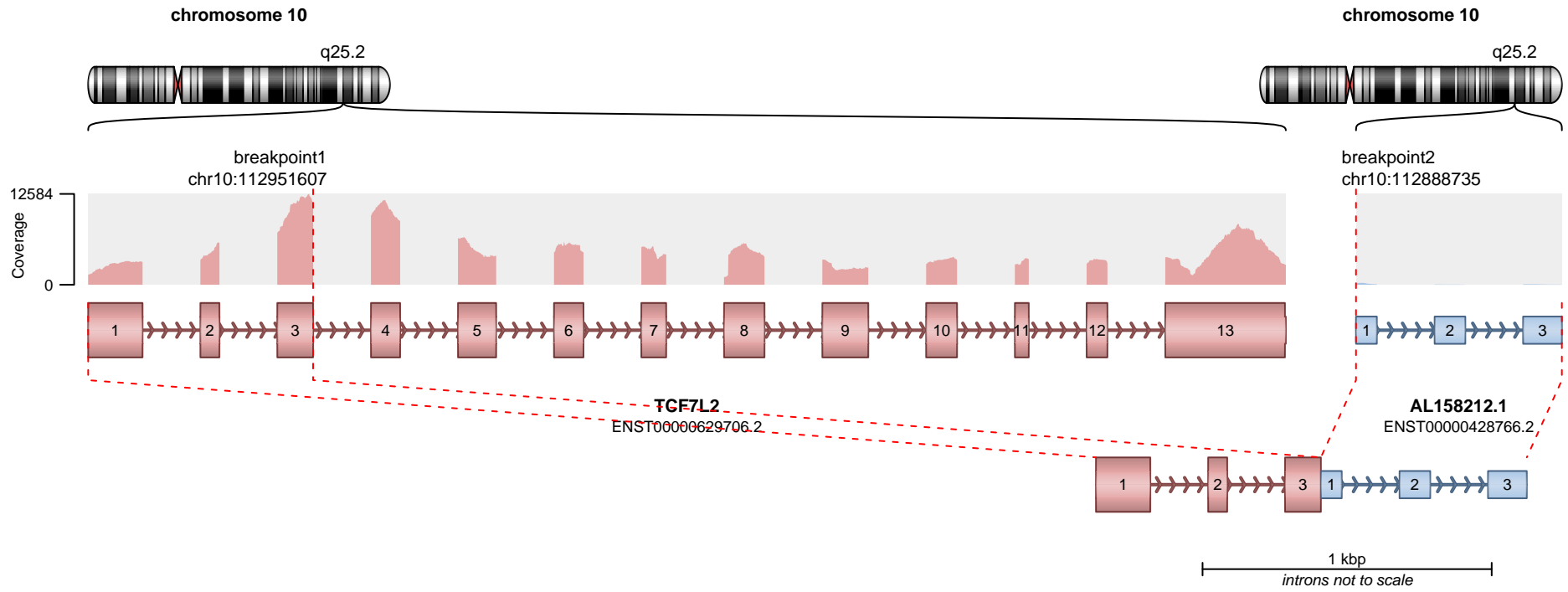

RETAINED PROTEIN DOMAINS
reading frame unclear

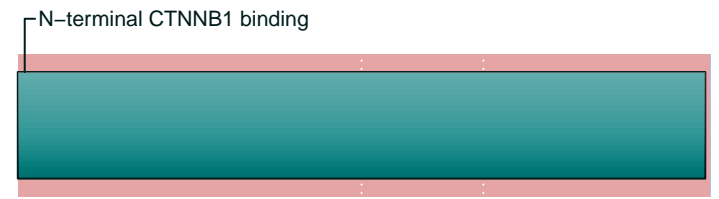

TCF7L2

SUPPORTING READ COUNT

Split reads = 2
Discordant mates = 0

- translocation
- duplication
- deletion
- inversion

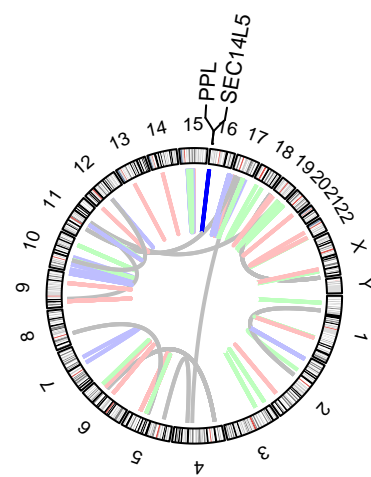
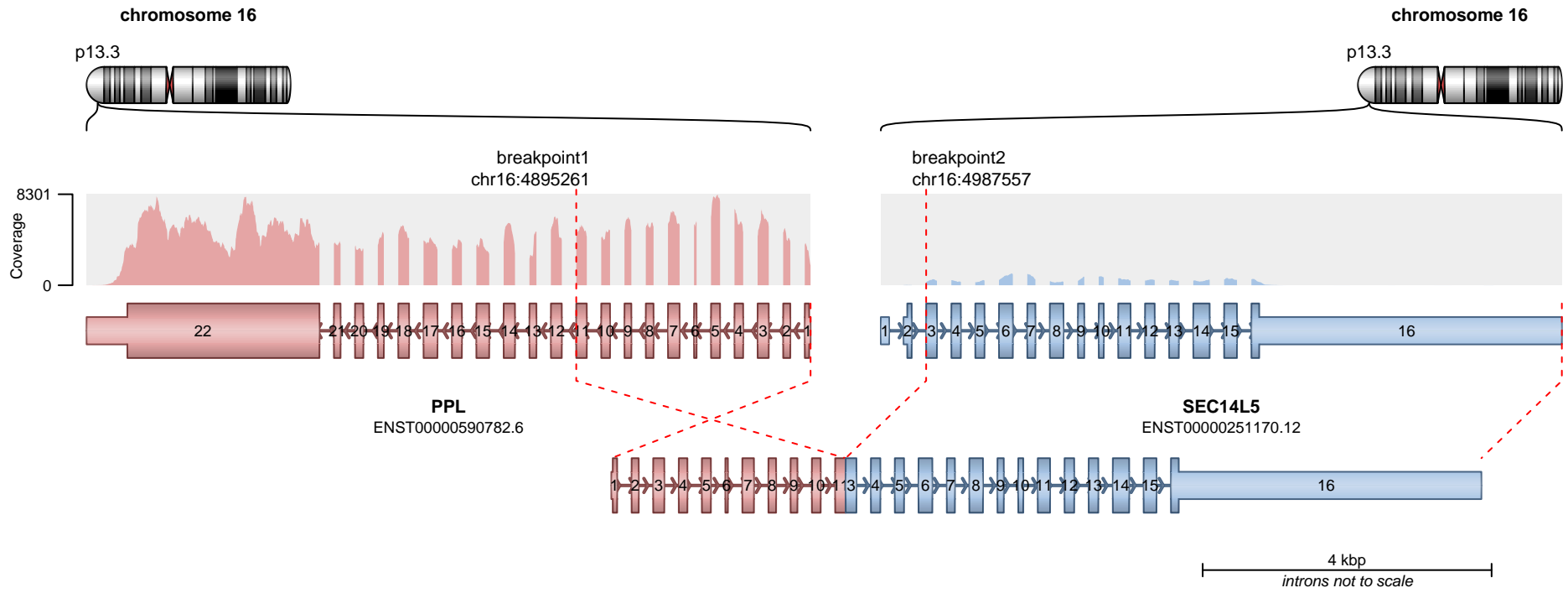

RETAINED PROTEIN DOMAINS
reading frame unclear

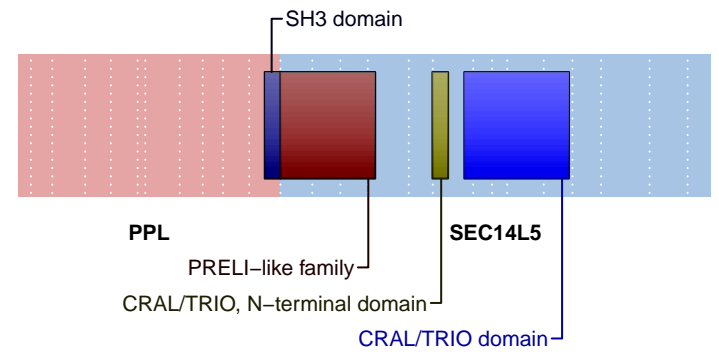

SUPPORTING READ COUNT

Split reads = 115
Discordant mates = 7

- translocation
- duplication
- deletion
- inversion

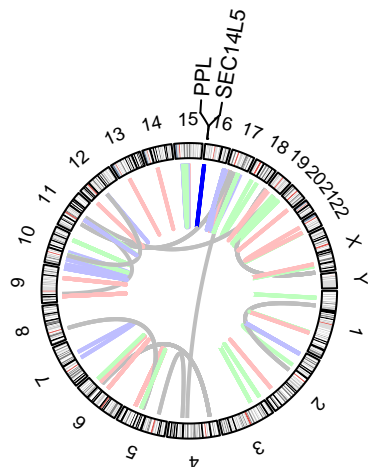
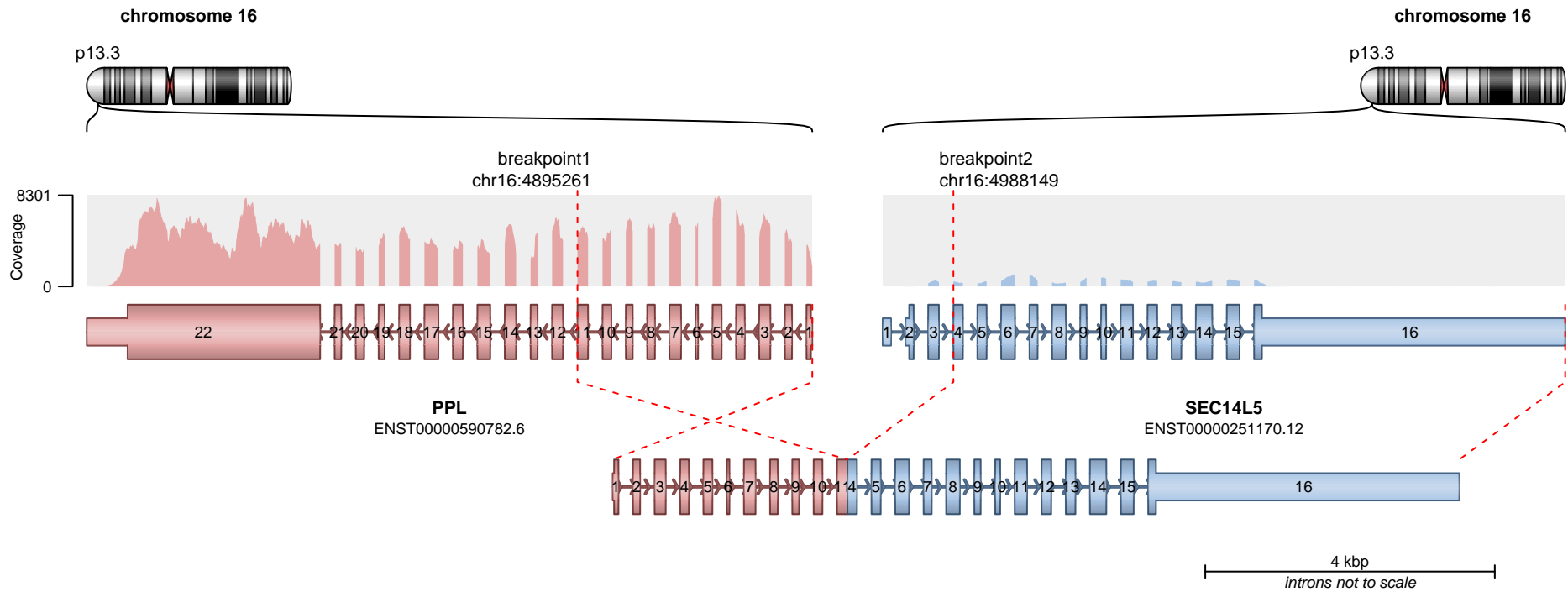

— translocation — deletion
— duplication — inversion

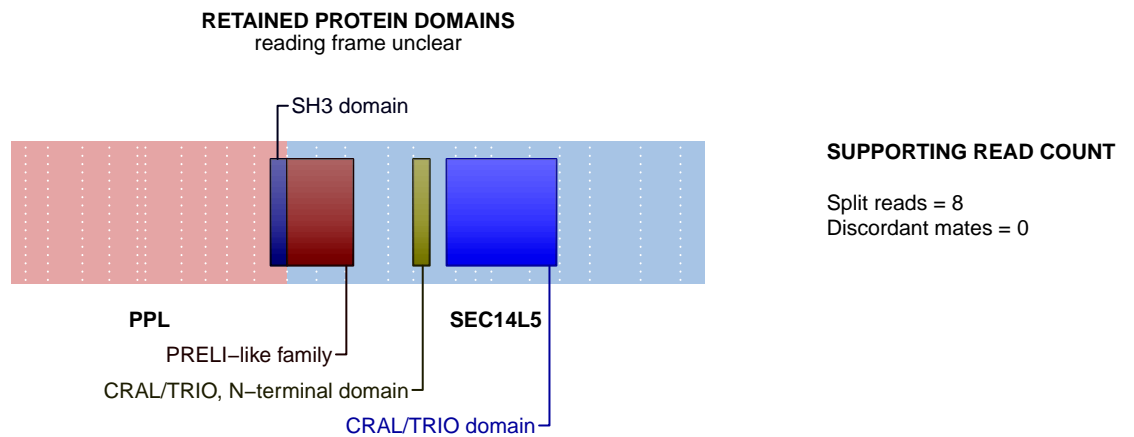

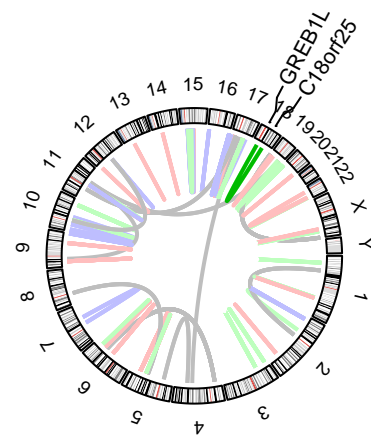
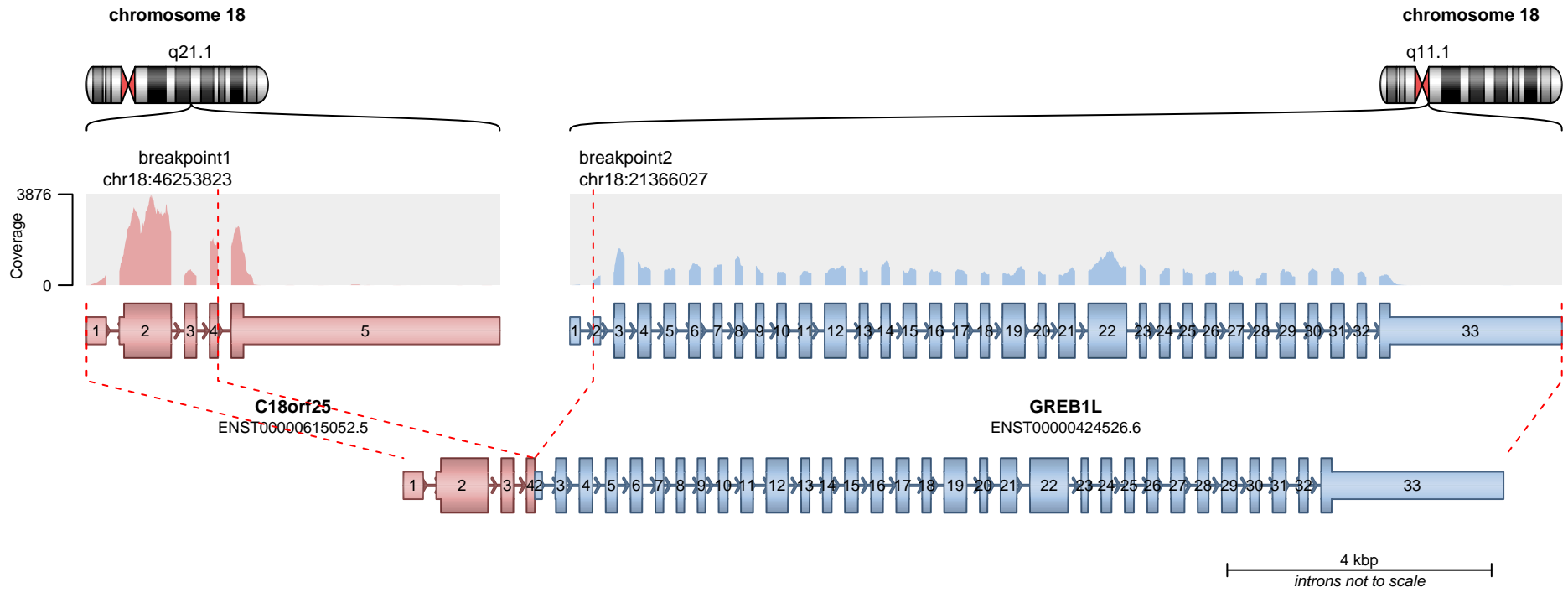

RETAINED PROTEIN DOMAINS
reading frame unclear

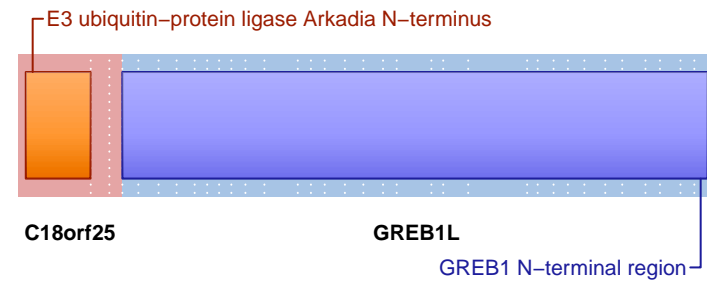

SUPPORTING READ COUNT

Split reads = 105
Discordant mates = 9

- translocation
- duplication
- deletion
- inversion

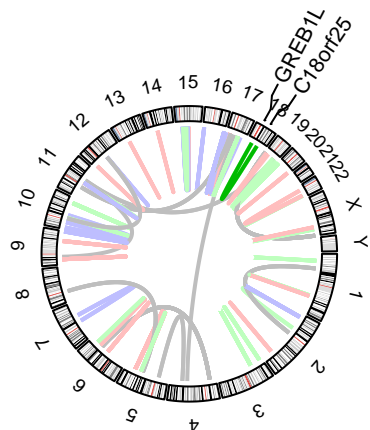
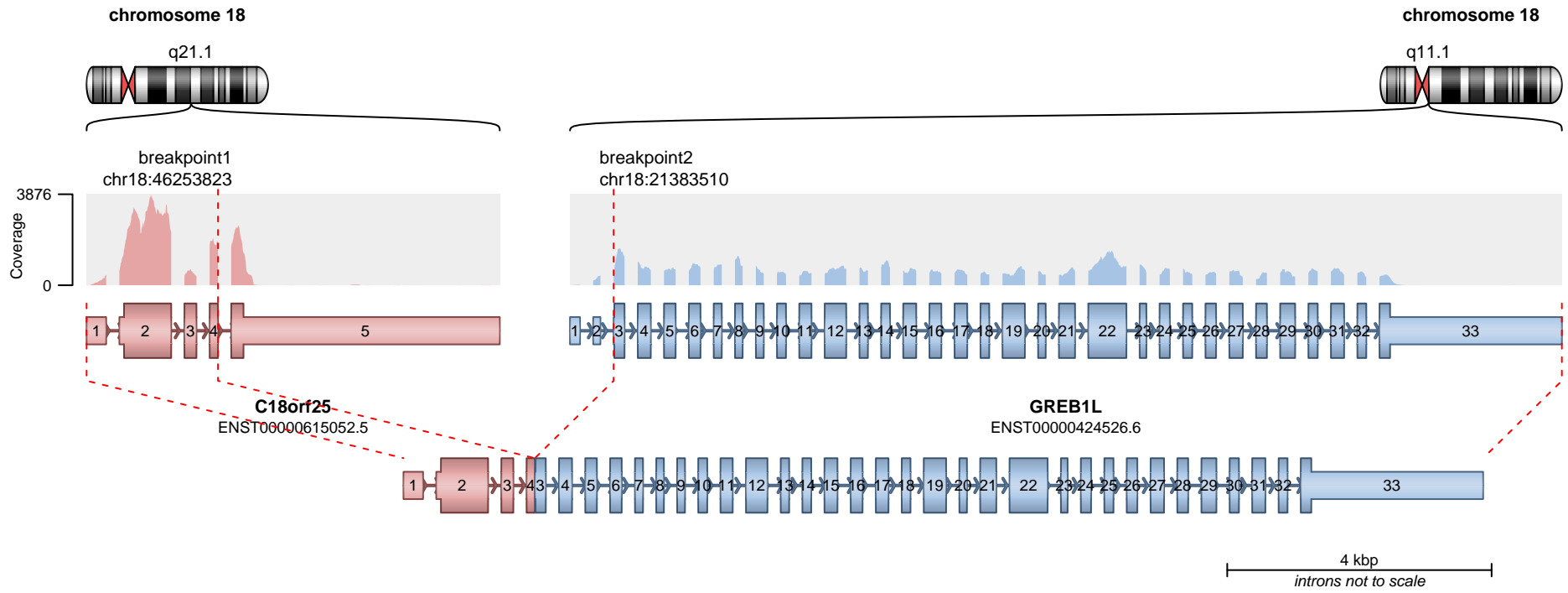

RETAINED PROTEIN DOMAINS
reading frame unclear

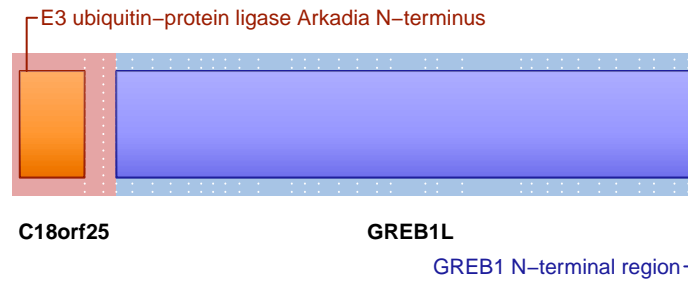

SUPPORTING READ COUNT

Split reads = 7
Discordant mates = 4

— translocation — deletion
— duplication — inversion

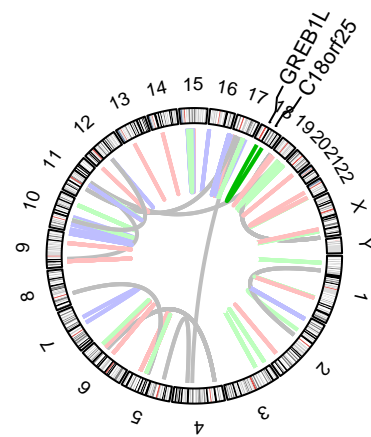
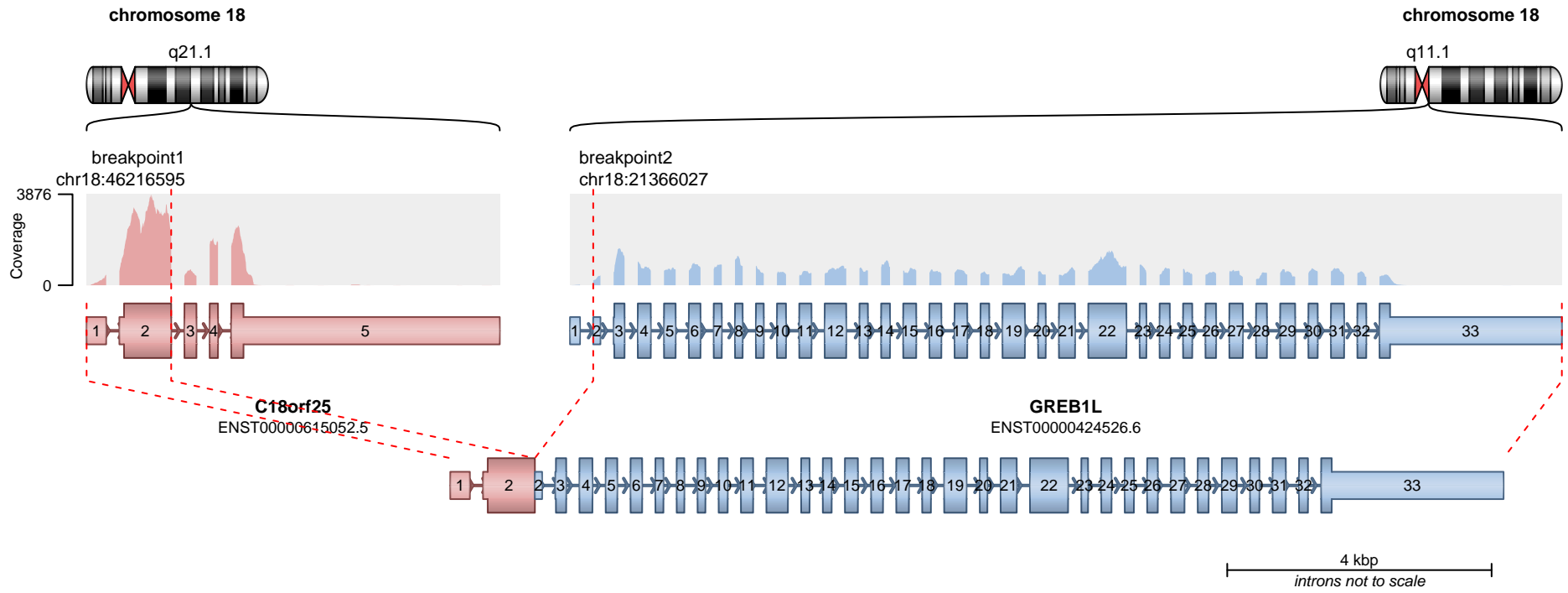

RETAINED PROTEIN DOMAINS
reading frame unclear

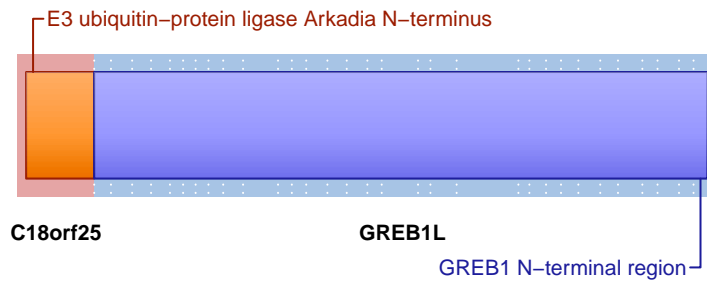

SUPPORTING READ COUNT

Split reads = 2
Discordant mates = 1

- translocation
- duplication
- deletion
- inversion

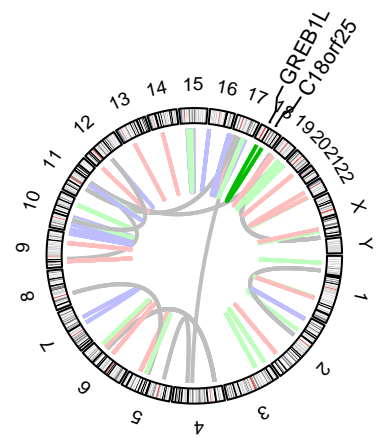
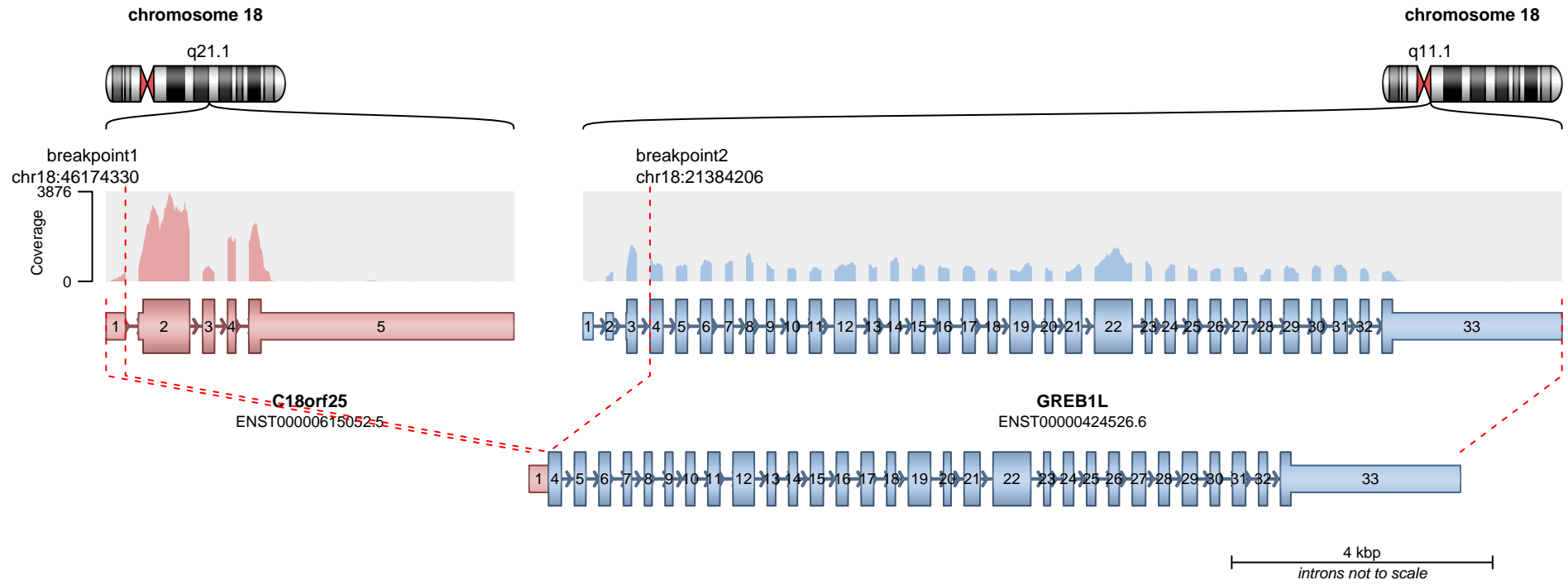

RETAINED PROTEIN DOMAINS
reading frame unclear

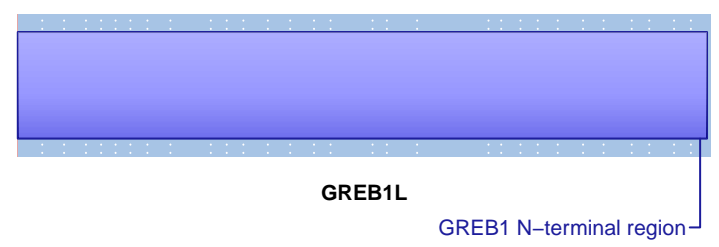

SUPPORTING READ COUNT

Split reads = 1
Discordant mates = 0

— translocation — deletion
— duplication — inversion

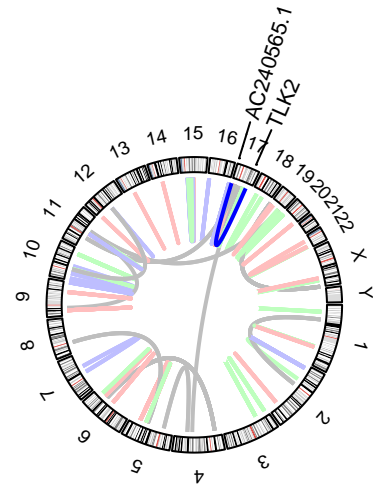
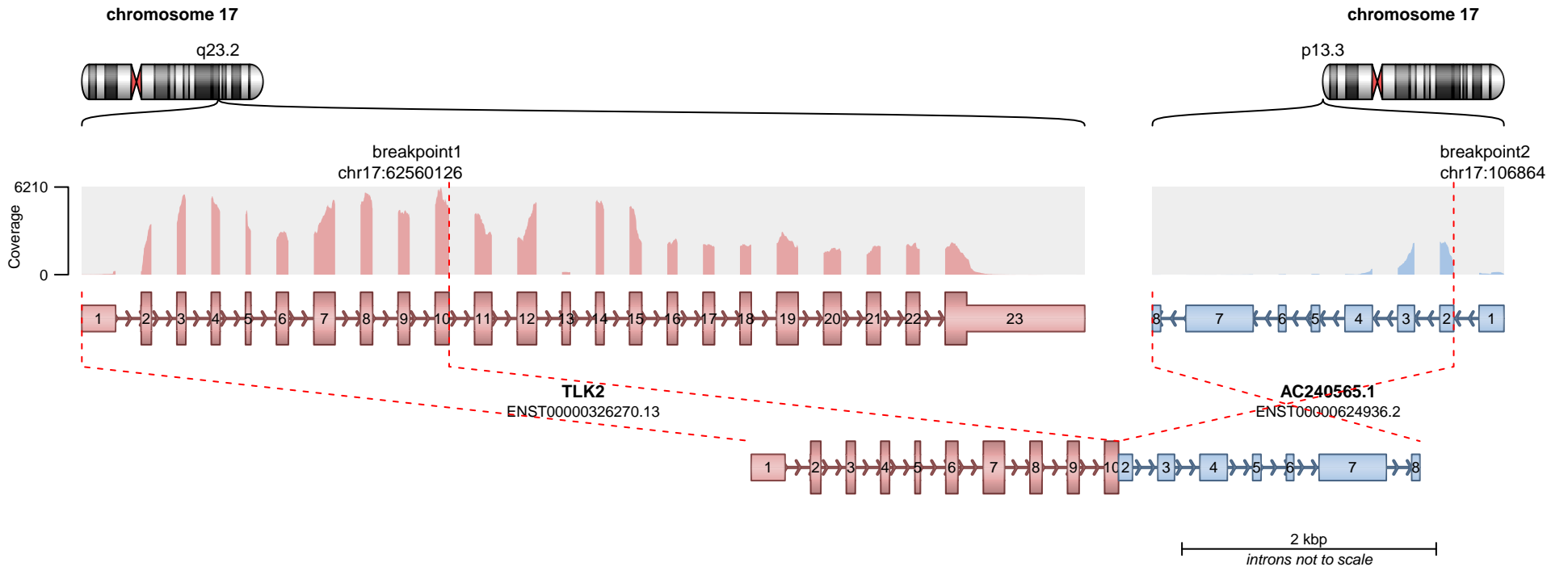

No protein domains retained in fusion.

SUPPORTING READ COUNT

Split reads = 105
Discordant mates = 2

— translocation — deletion
— duplication — inversion

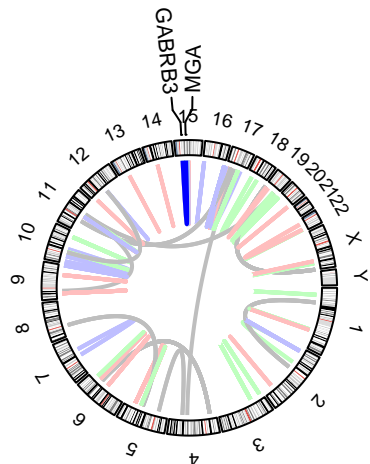
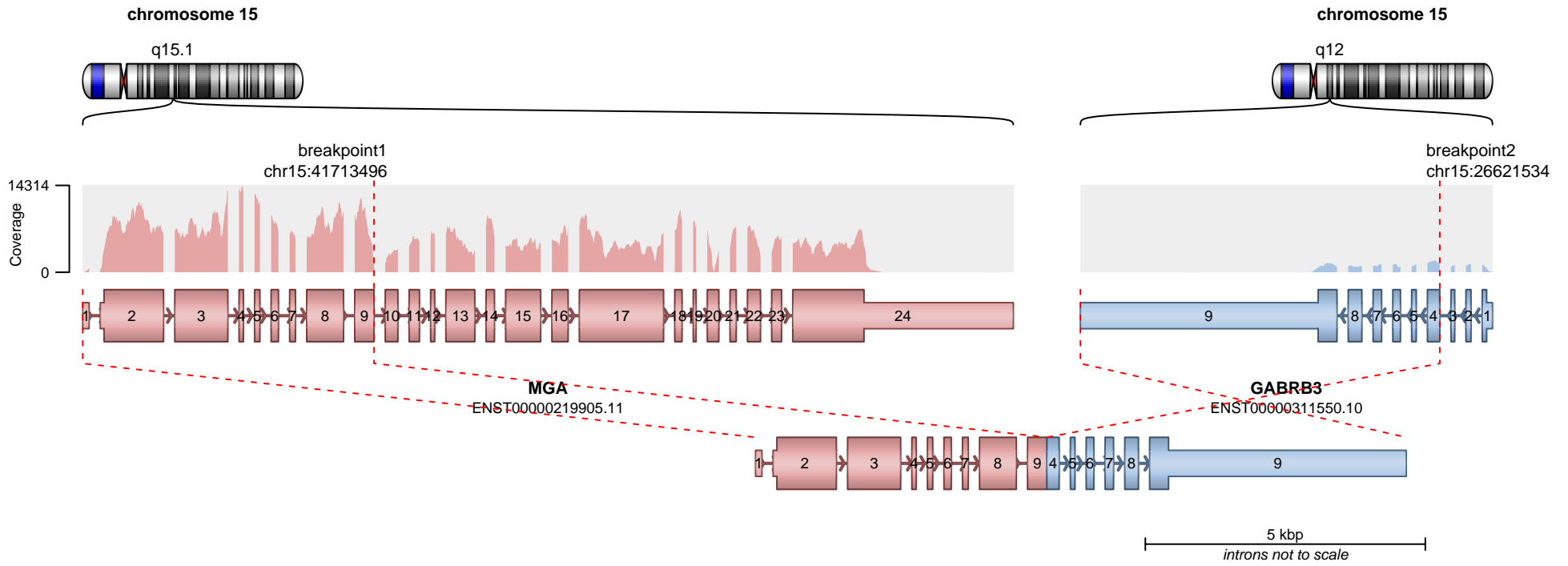

RETAINED PROTEIN DOMAINS
reading frame unclear

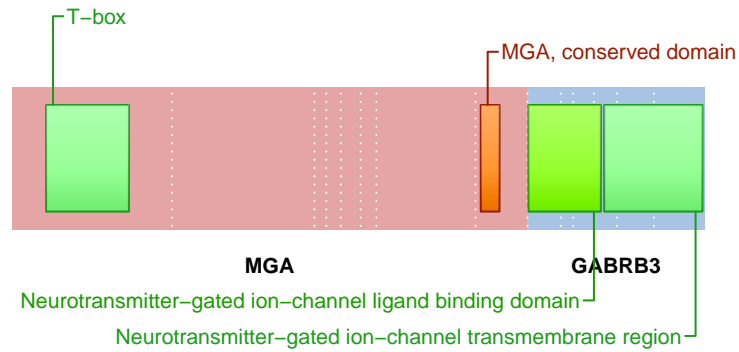

SUPPORTING READ COUNT

Split reads = 88
Discordant mates = 6

— translocation — deletion
— duplication — inversion

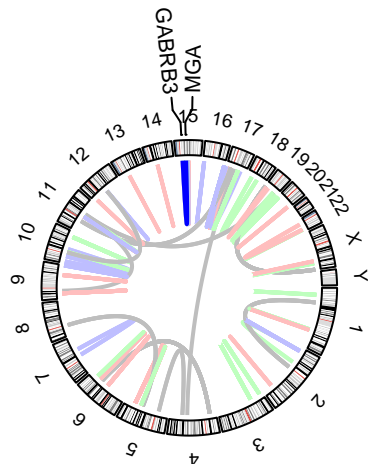
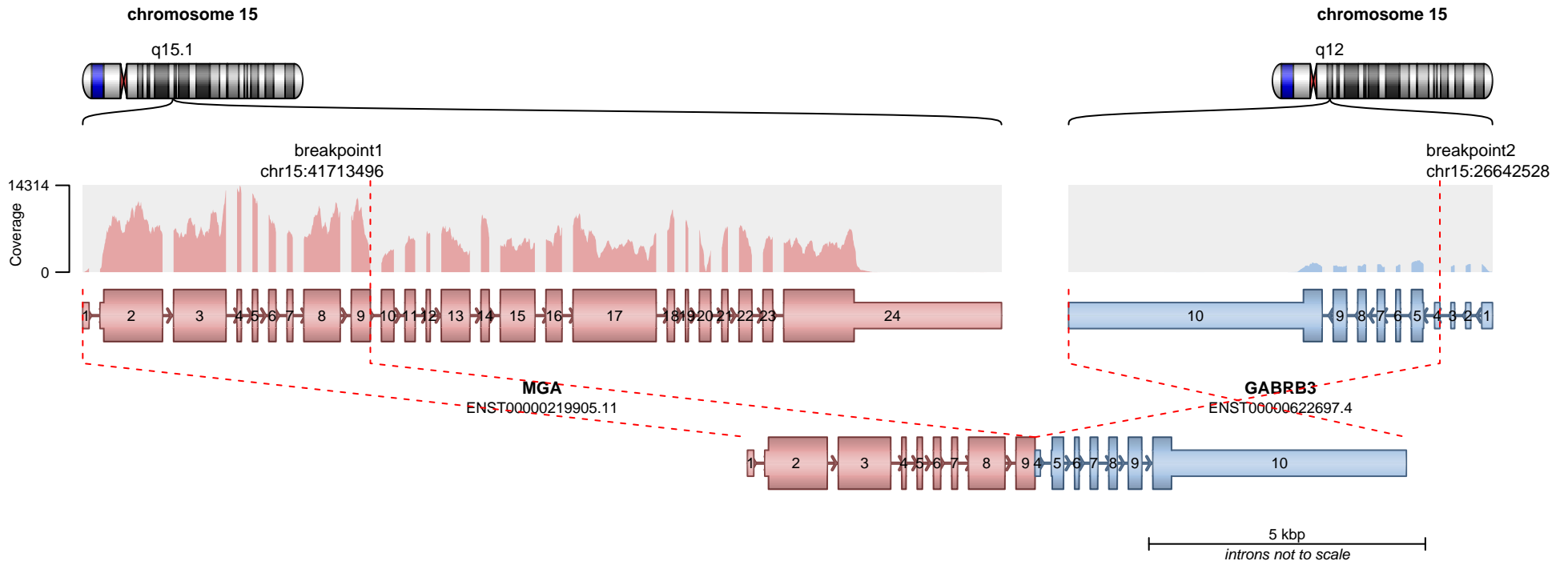

RETAINED PROTEIN DOMAINS
reading frame unclear

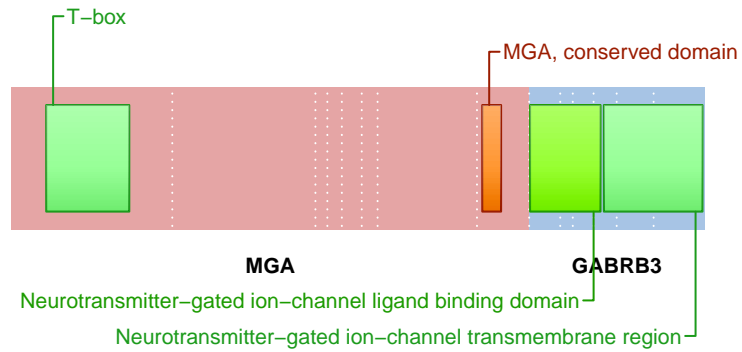

SUPPORTING READ COUNT

Split reads = 9
Discordant mates = 11

— translocation — deletion
— duplication — inversion

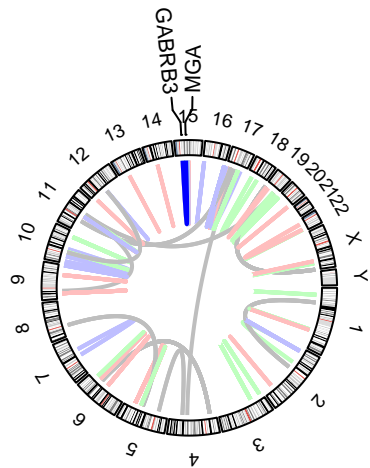
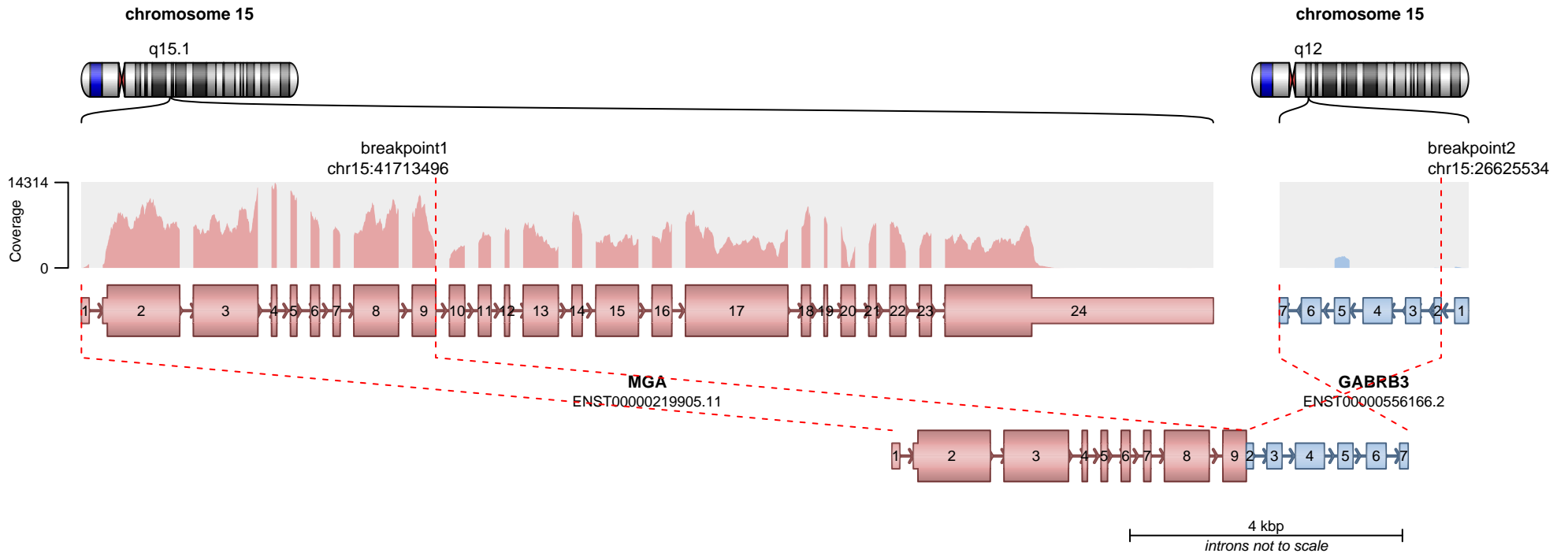

RETAINED PROTEIN DOMAINS
reading frame unclear

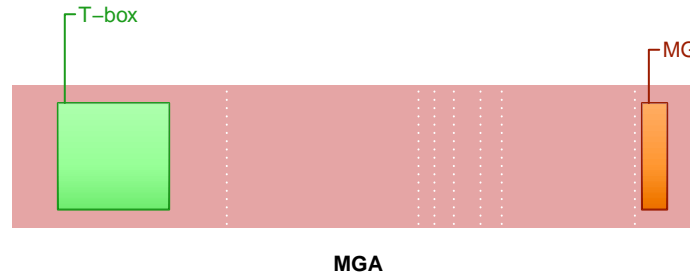

SUPPORTING READ COUNT

Split reads = 10
Discordant mates = 6

- translocation
- duplication
- deletion
- inversion

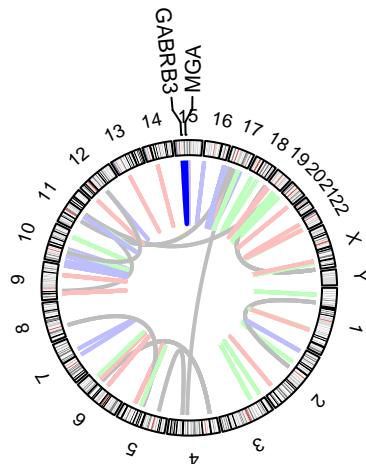
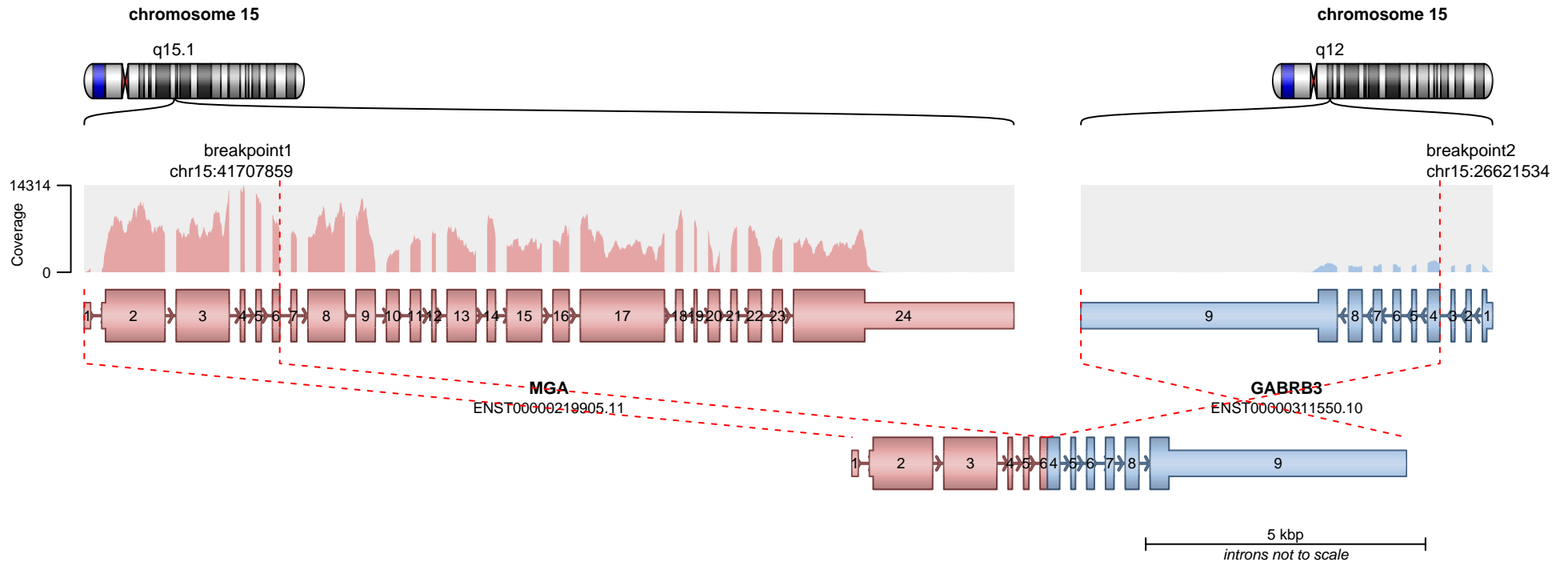

RETAINED PROTEIN DOMAINS
reading frame unclear

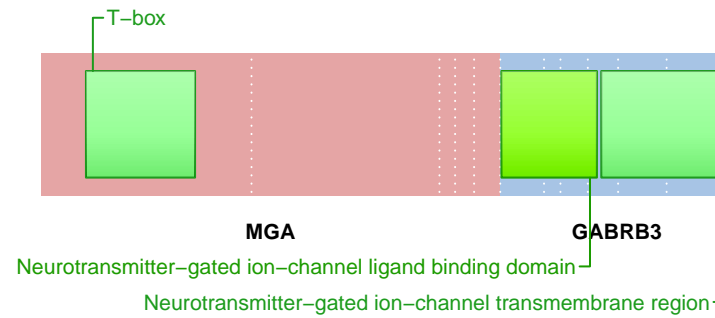

SUPPORTING READ COUNT

Split reads = 1
Discordant mates = 0

— translocation — deletion
— duplication — inversion

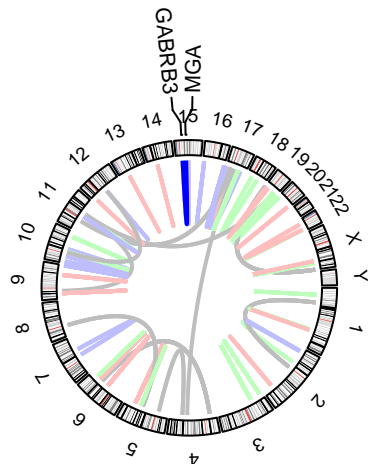
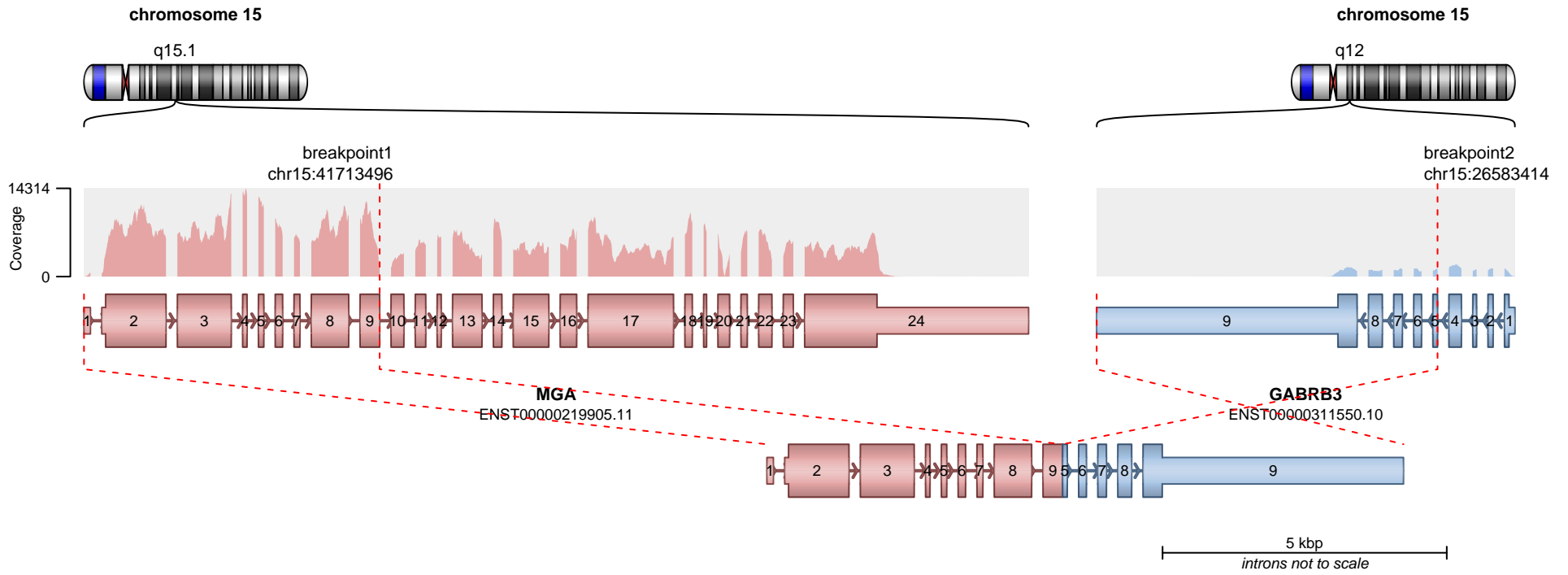

RETAINED PROTEIN DOMAINS
reading frame unclear

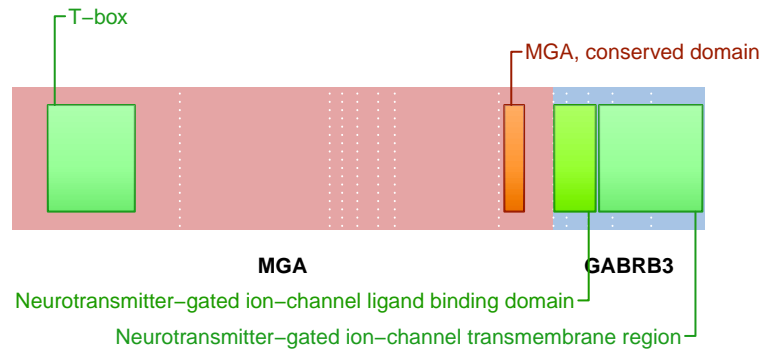

SUPPORTING READ COUNT

Split reads = 1
Discordant mates = 0

— translocation — deletion
— duplication — inversion

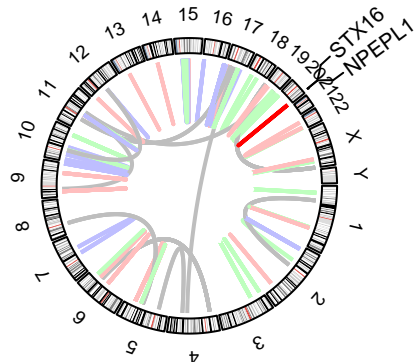
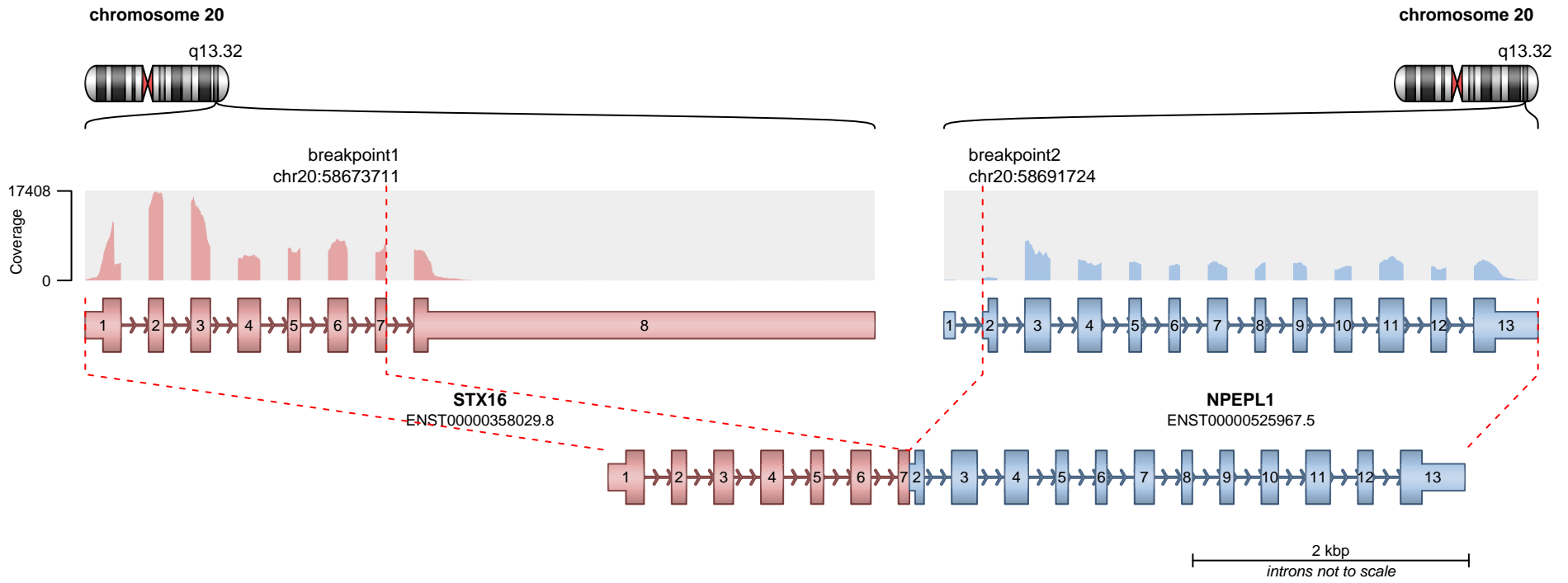

RETAINED PROTEIN DOMAINS
reading frame unclear

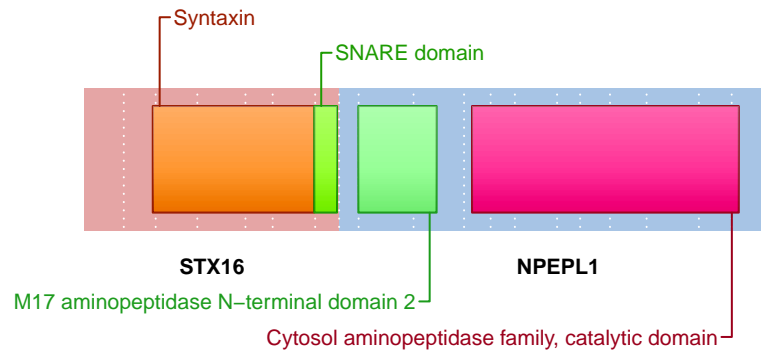

SUPPORTING READ COUNT

Split reads = 85
Discordant mates = 2

- translocation
- duplication
- deletion
- inversion

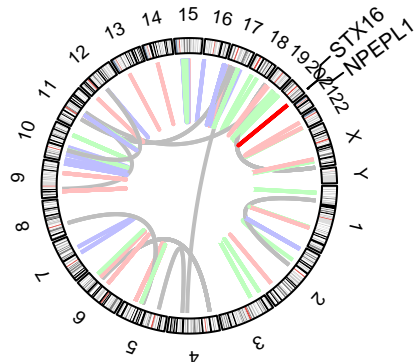
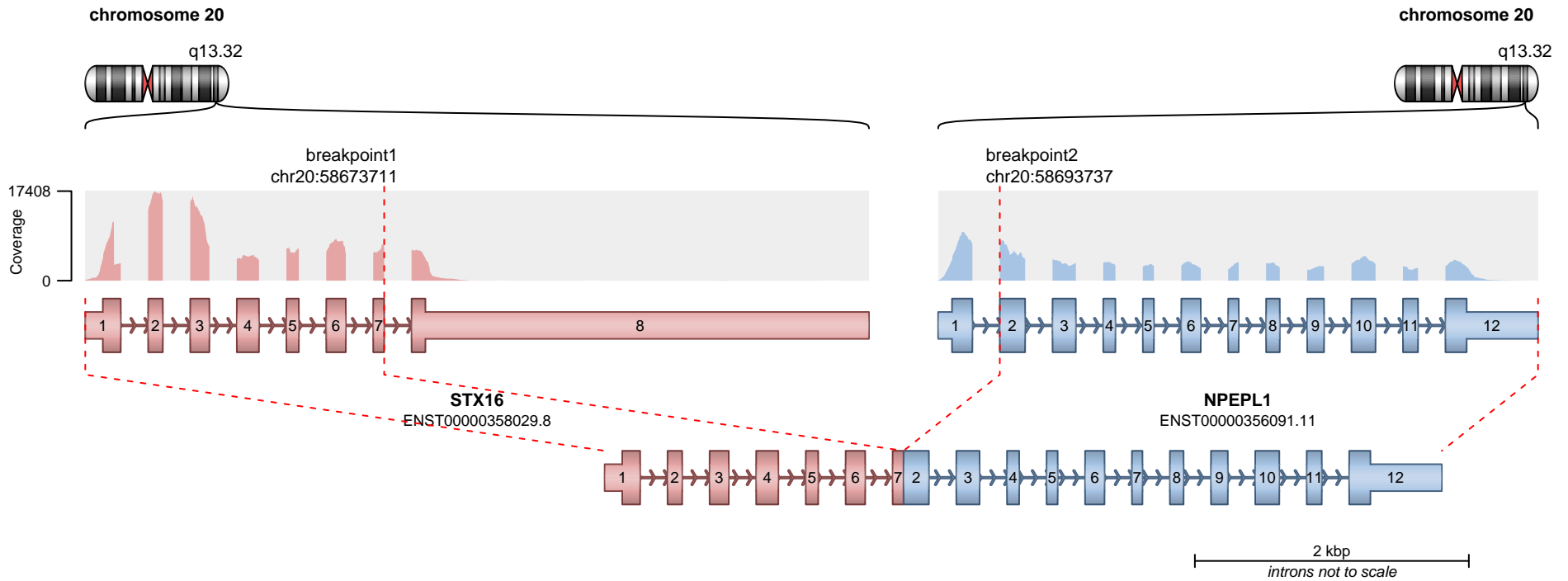

RETAINED PROTEIN DOMAINS
reading frame unclear

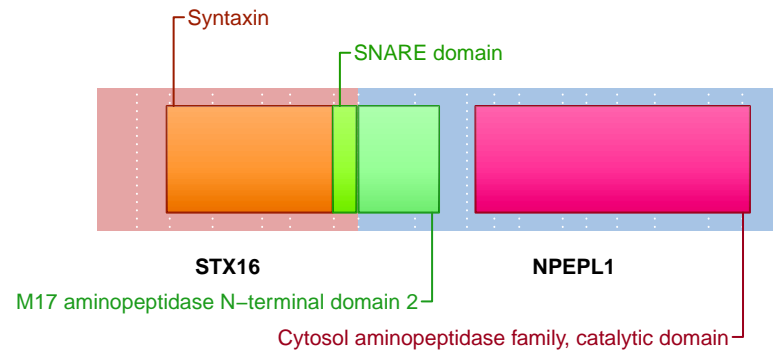

SUPPORTING READ COUNT

Split reads = 1
Discordant mates = 1

— translocation — deletion
— duplication — inversion

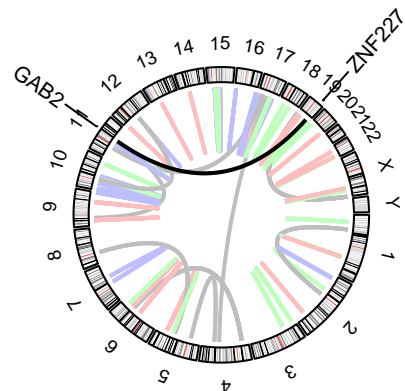
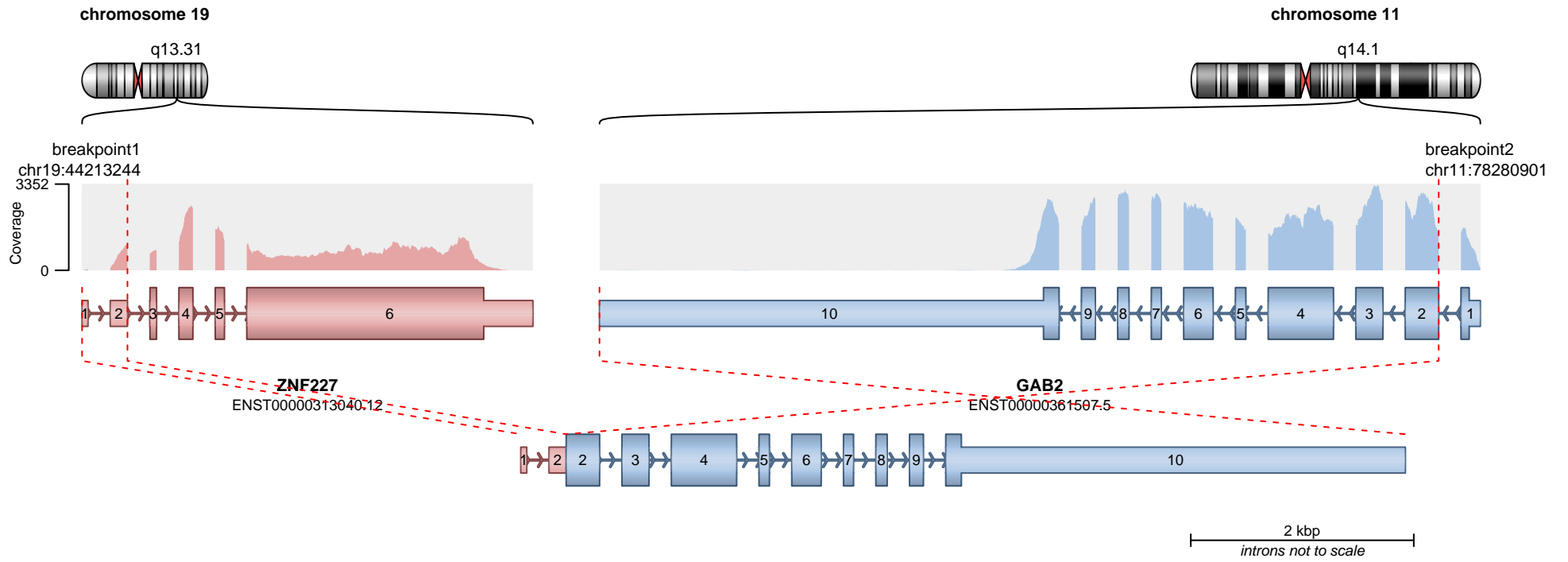

RETAINED PROTEIN DOMAINS
reading frame unclear

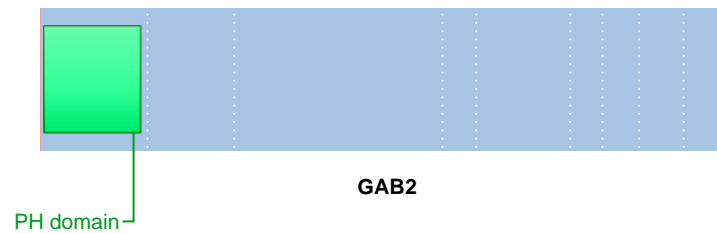

SUPPORTING READ COUNT

Split reads = 76
Discordant mates = 6

— translocation — deletion
— duplication — inversion

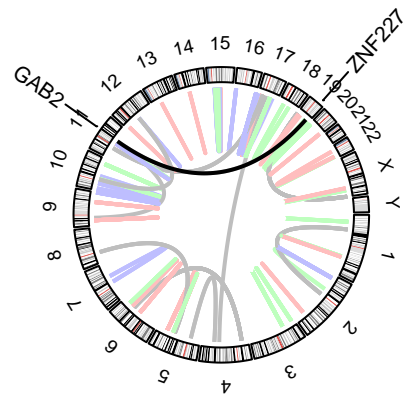
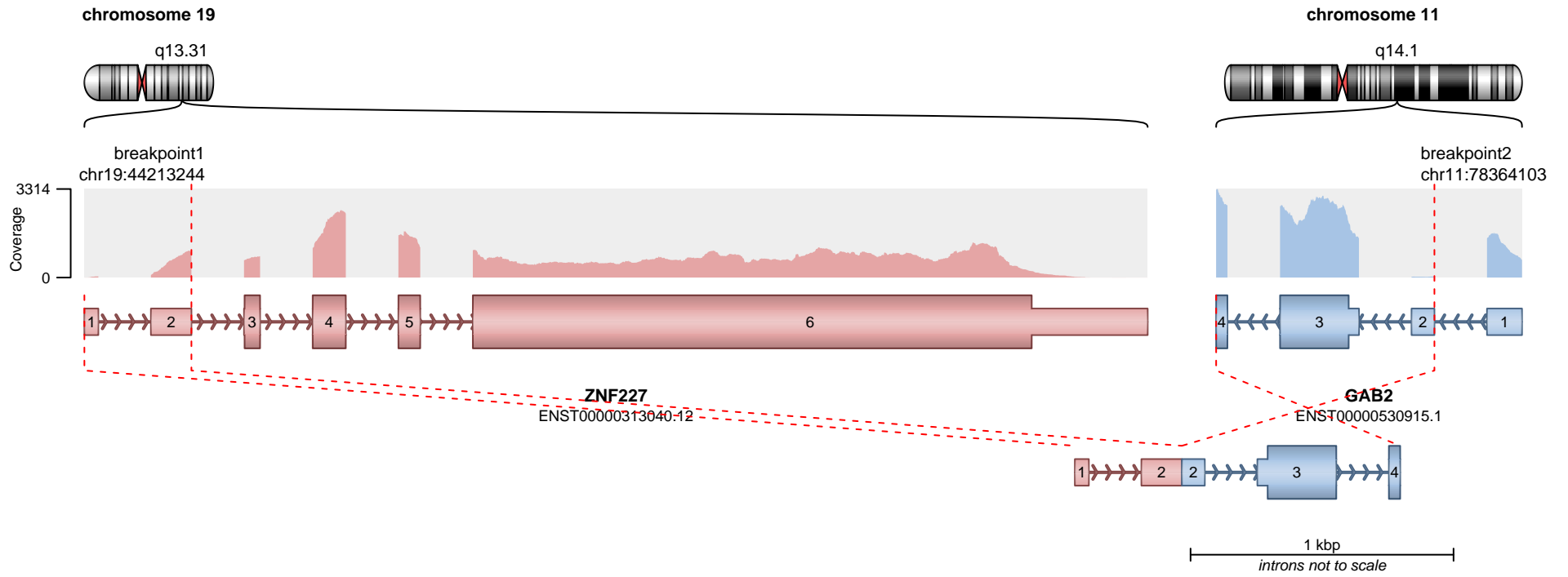

RETAINED PROTEIN DOMAINS
reading frame unclear

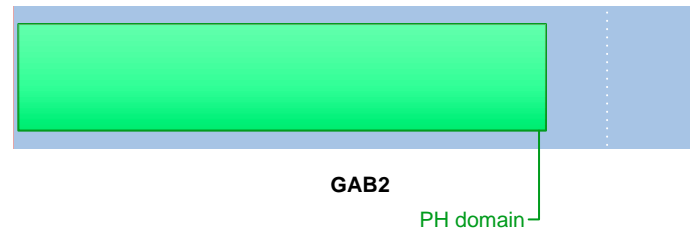

SUPPORTING READ COUNT

Split reads = 2
Discordant mates = 6

— translocation — deletion
— duplication — inversion

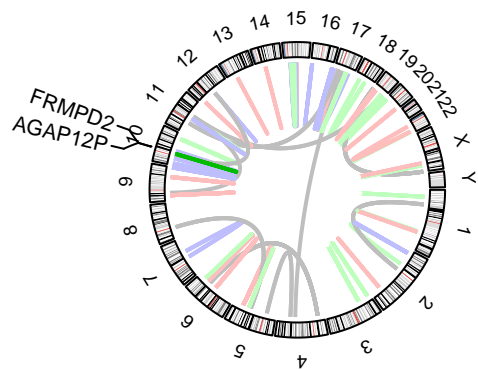
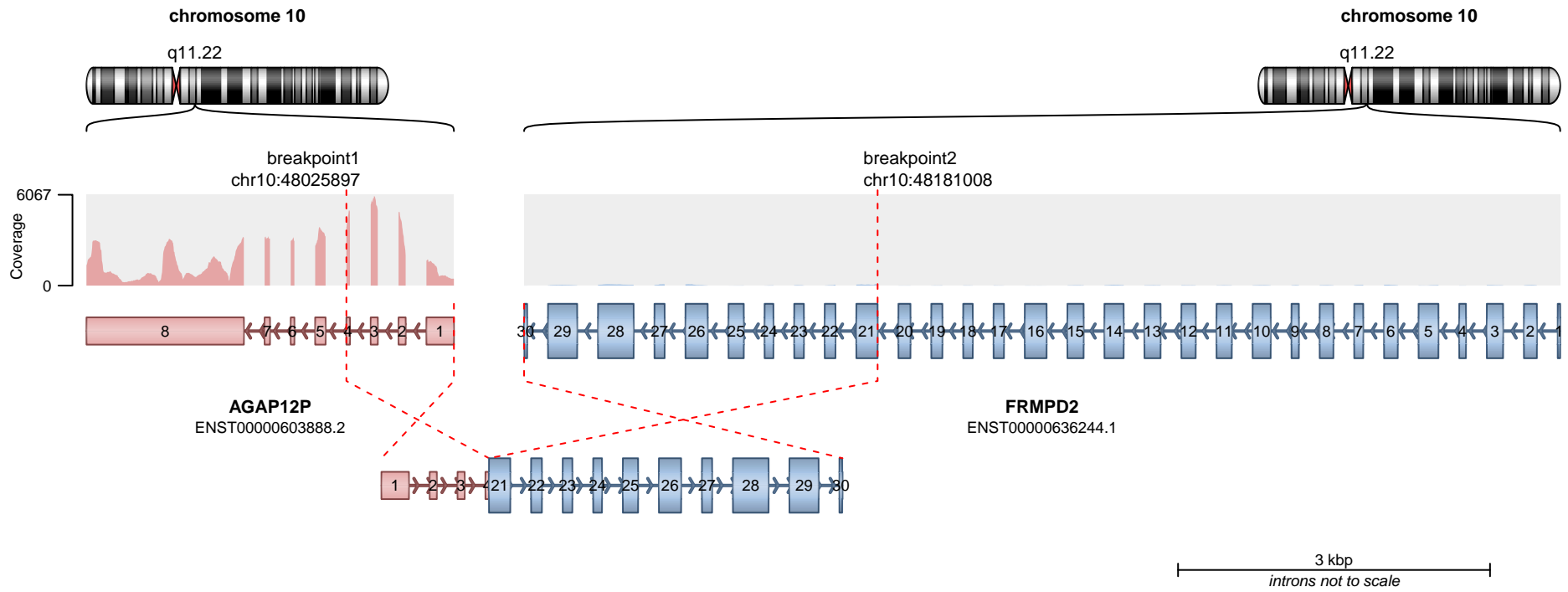

RETAINED PROTEIN DOMAINS
reading frame unclear

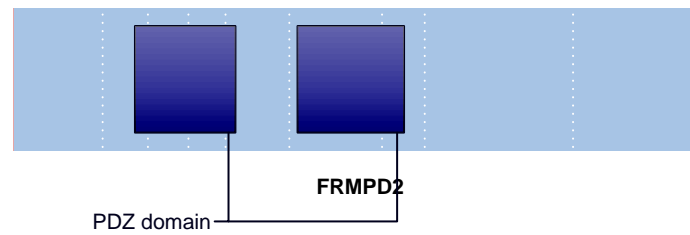

SUPPORTING READ COUNT

Split reads = 72
Discordant mates = 1

— translocation — deletion
— duplication — inversion

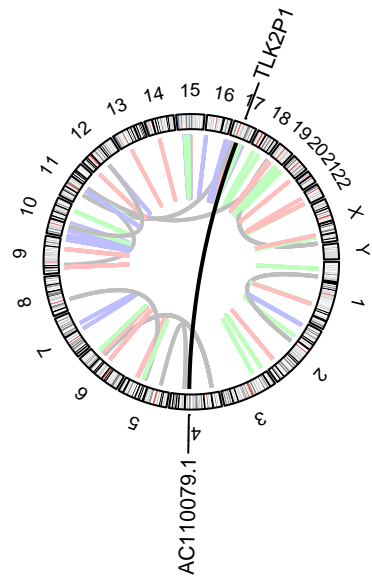
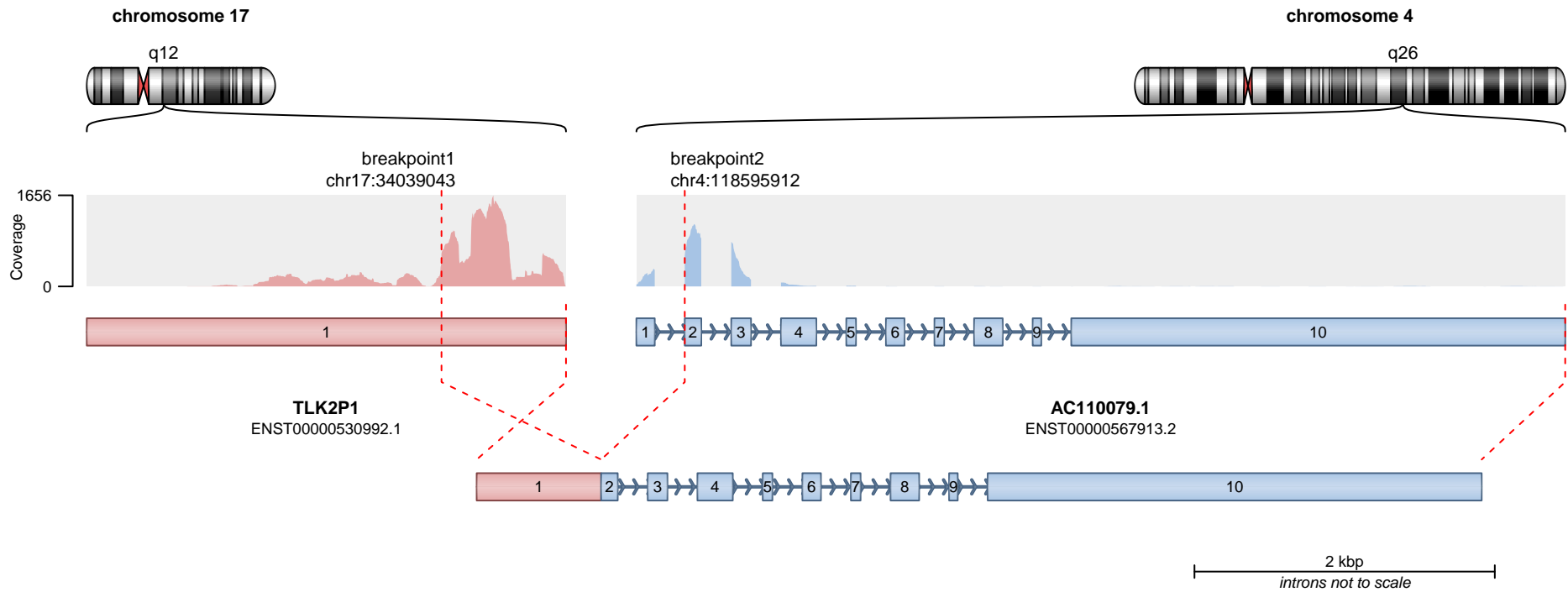

— translocation — deletion
 — duplication — inversion

Genes are not protein-coding.

SUPPORTING READ COUNT

Split reads = 72
 Discordant mates = 0

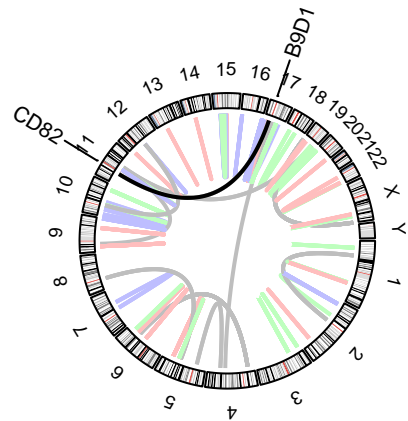
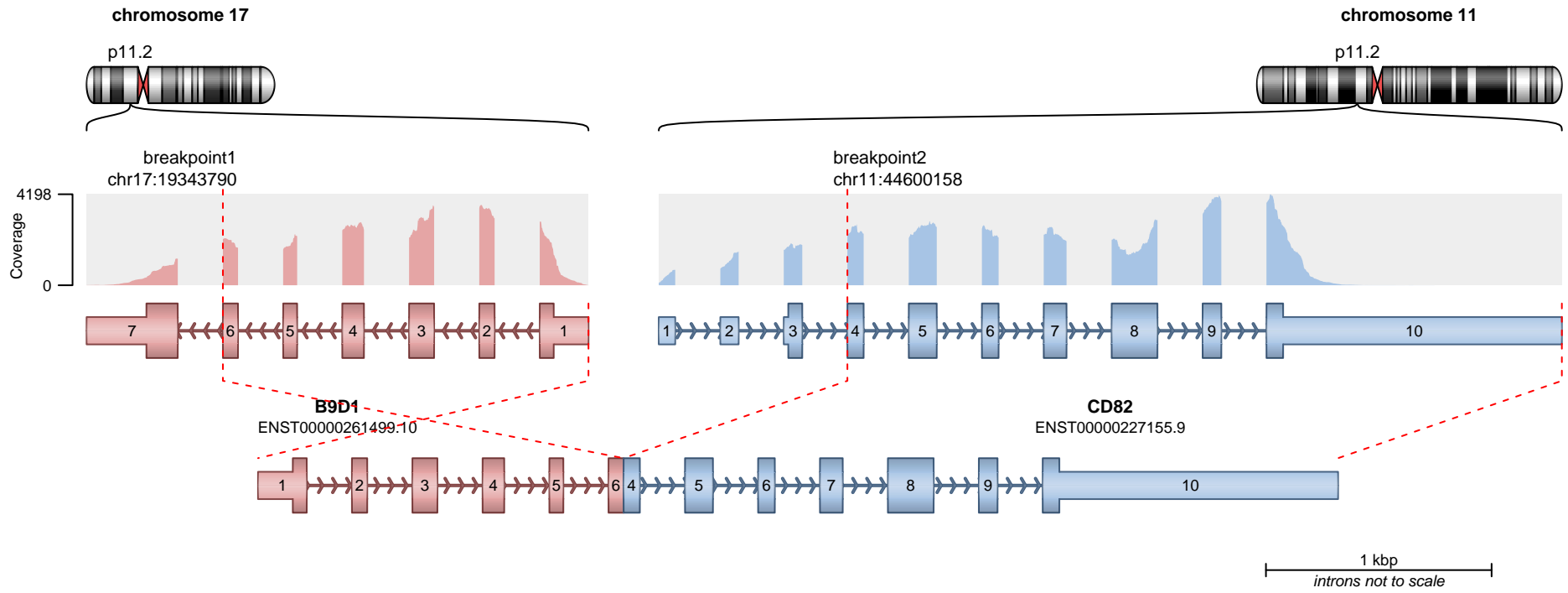

RETAINED PROTEIN DOMAINS
reading frame unclear

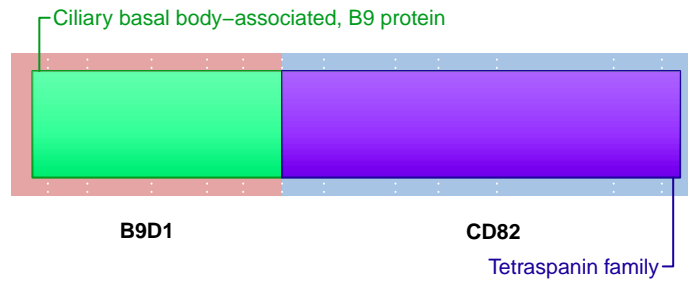

SUPPORTING READ COUNT

Split reads = 69
Discordant mates = 5

— translocation — deletion
— duplication — inversion

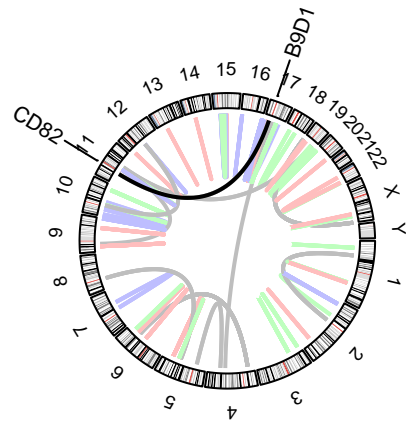
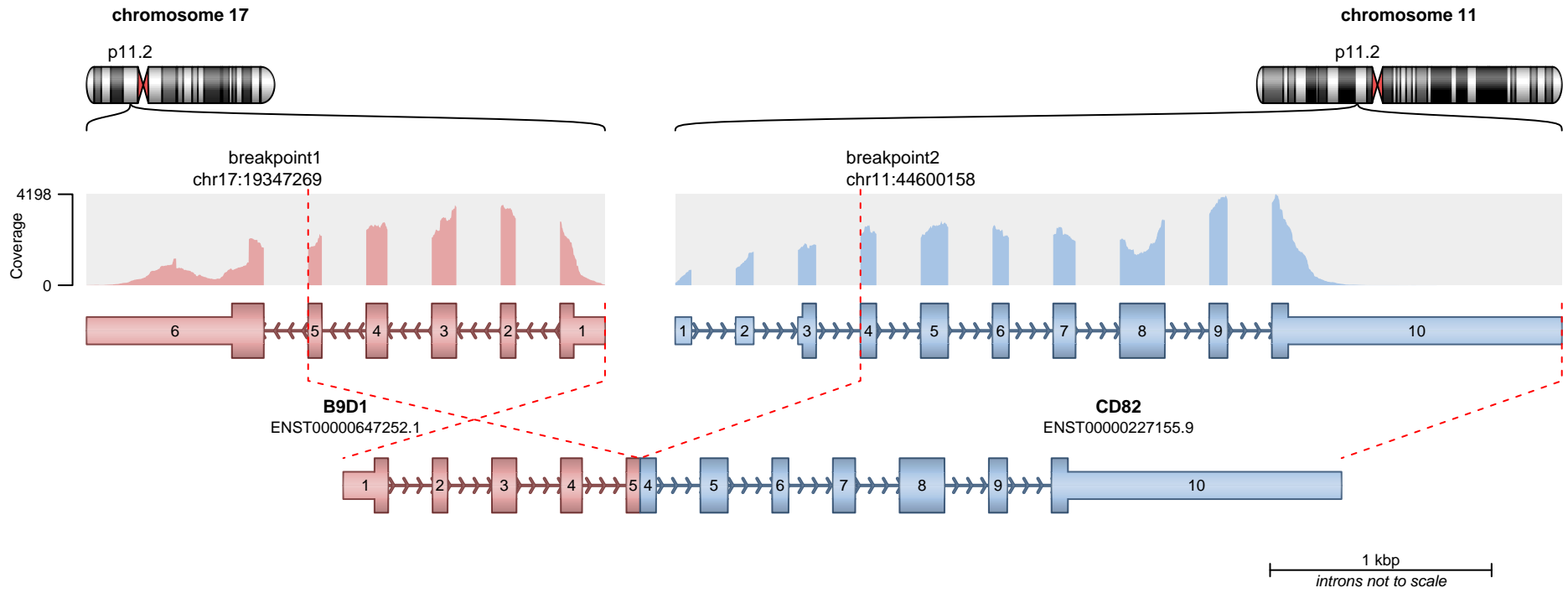

RETAINED PROTEIN DOMAINS
reading frame unclear

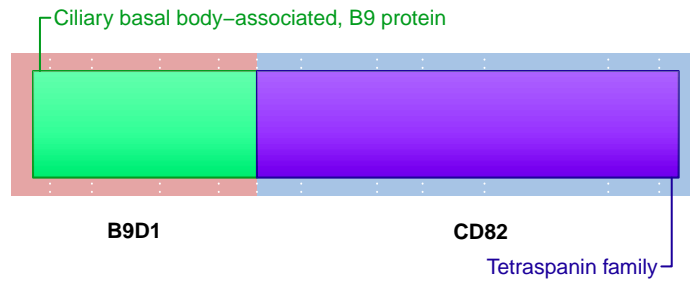

SUPPORTING READ COUNT

Split reads = 8
Discordant mates = 3

- translocation
- duplication
- deletion
- inversion

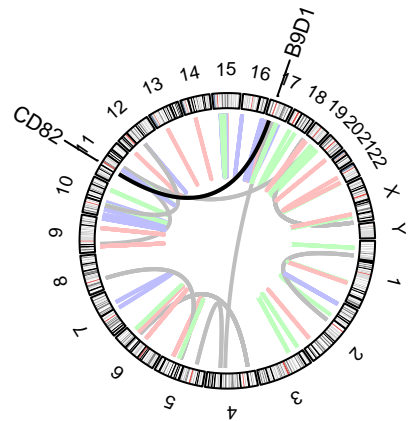
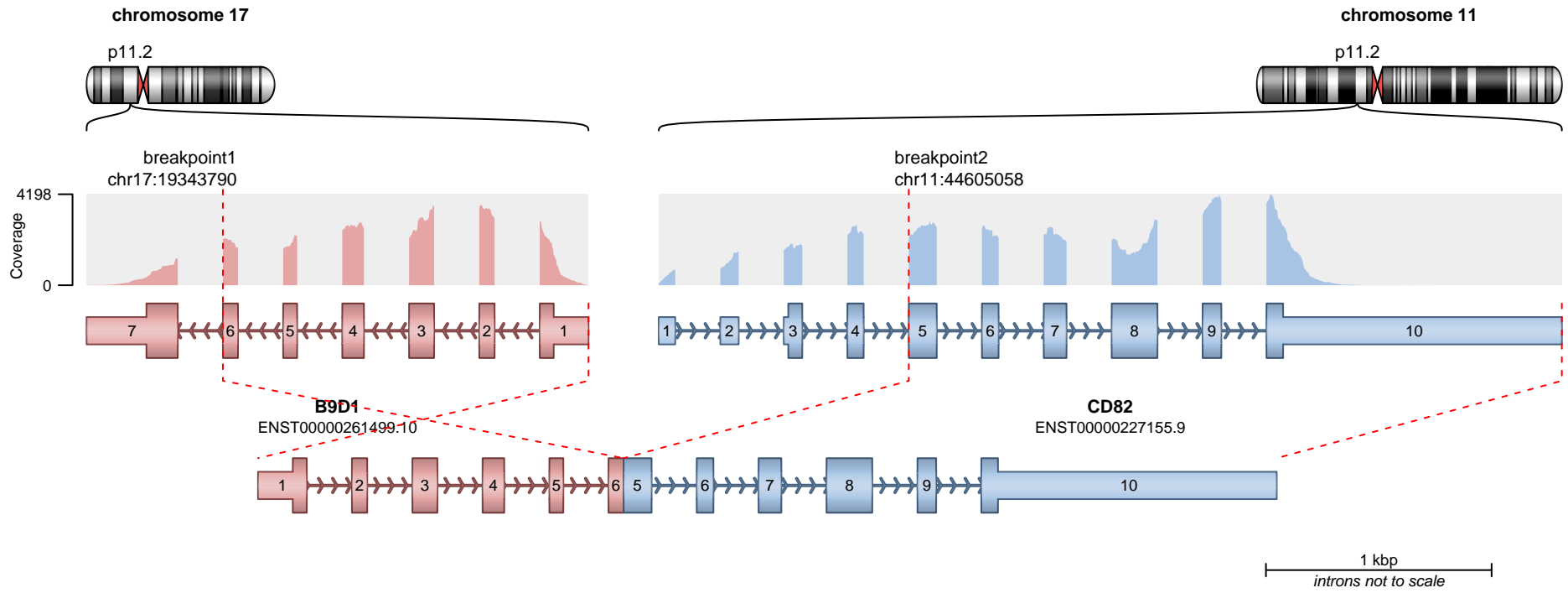

RETAINED PROTEIN DOMAINS
reading frame unclear

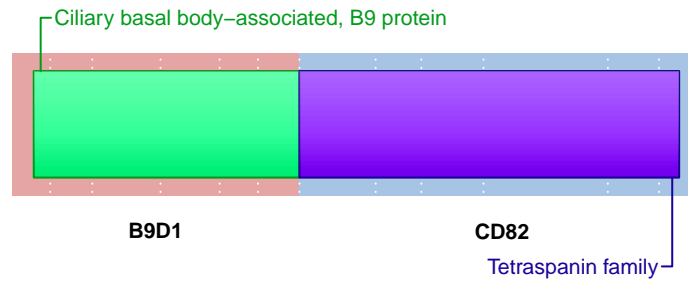

SUPPORTING READ COUNT

Split reads = 4
Discordant mates = 2

— translocation — deletion
— duplication — inversion

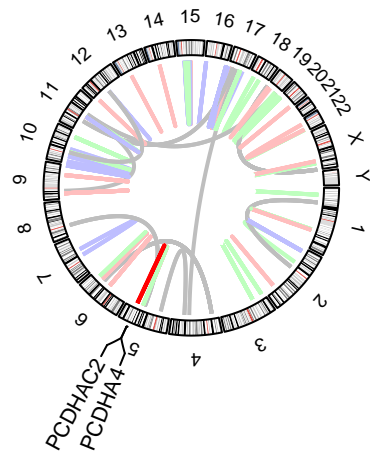
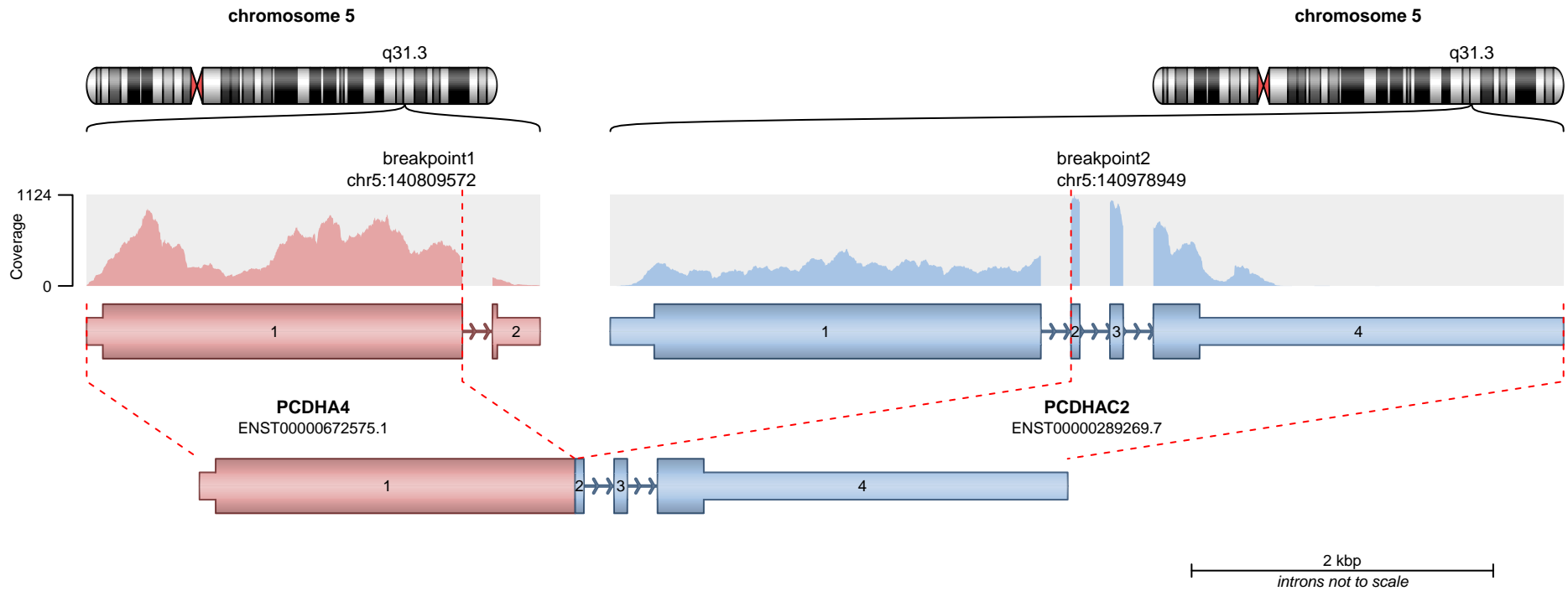

— translocation — deletion
— duplication — inversion

RETAINED PROTEIN DOMAINS
reading frame unclear

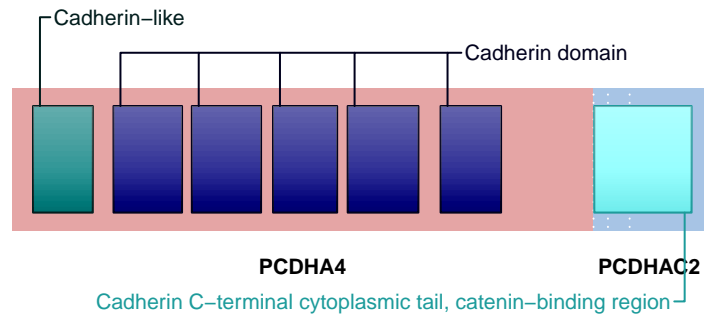

SUPPORTING READ COUNT

Split reads = 68
Discordant mates = 1

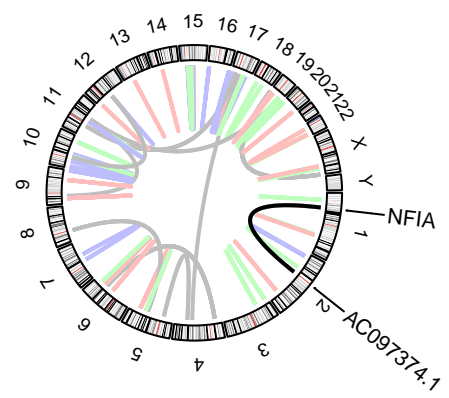
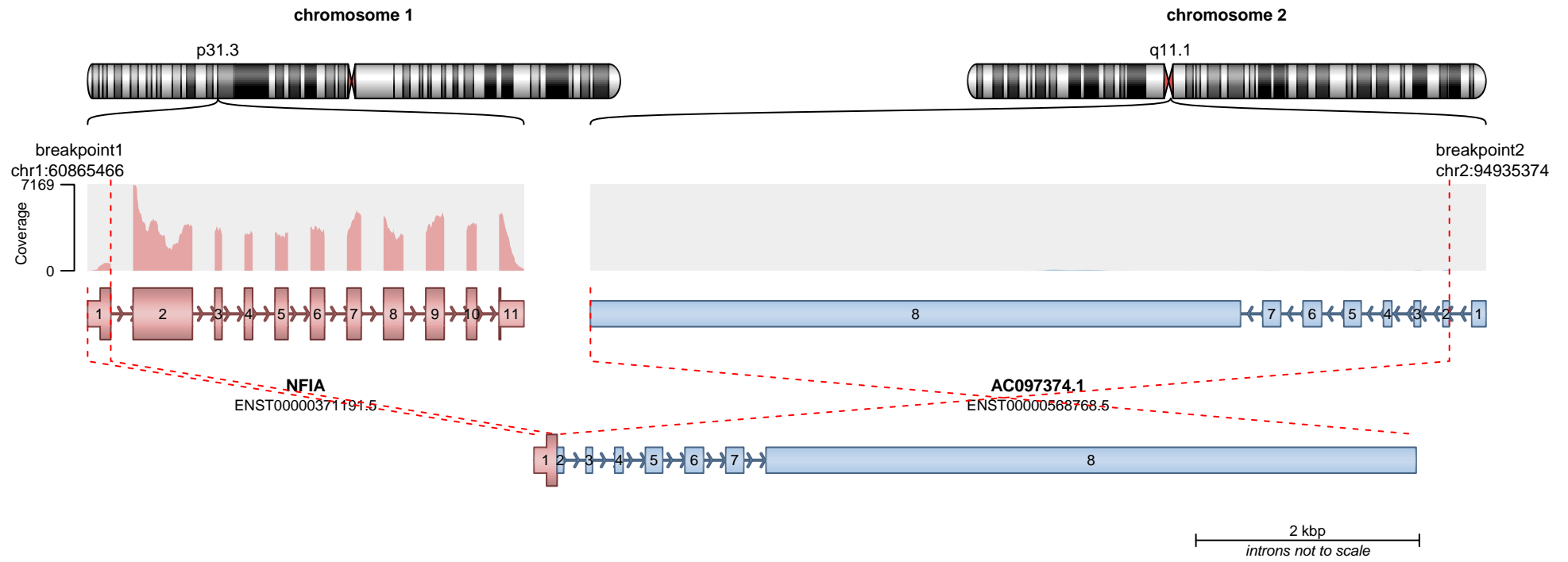

No protein domains retained in fusion.

SUPPORTING READ COUNT

Split reads = 56
Discordant mates = 0

- translocation
- duplication
- deletion
- inversion

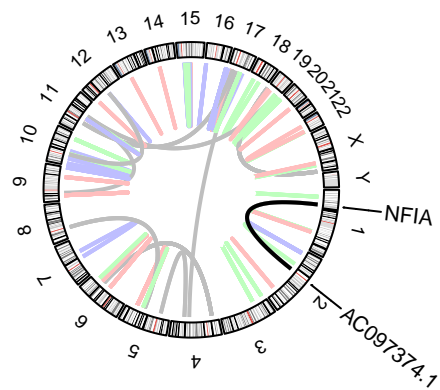
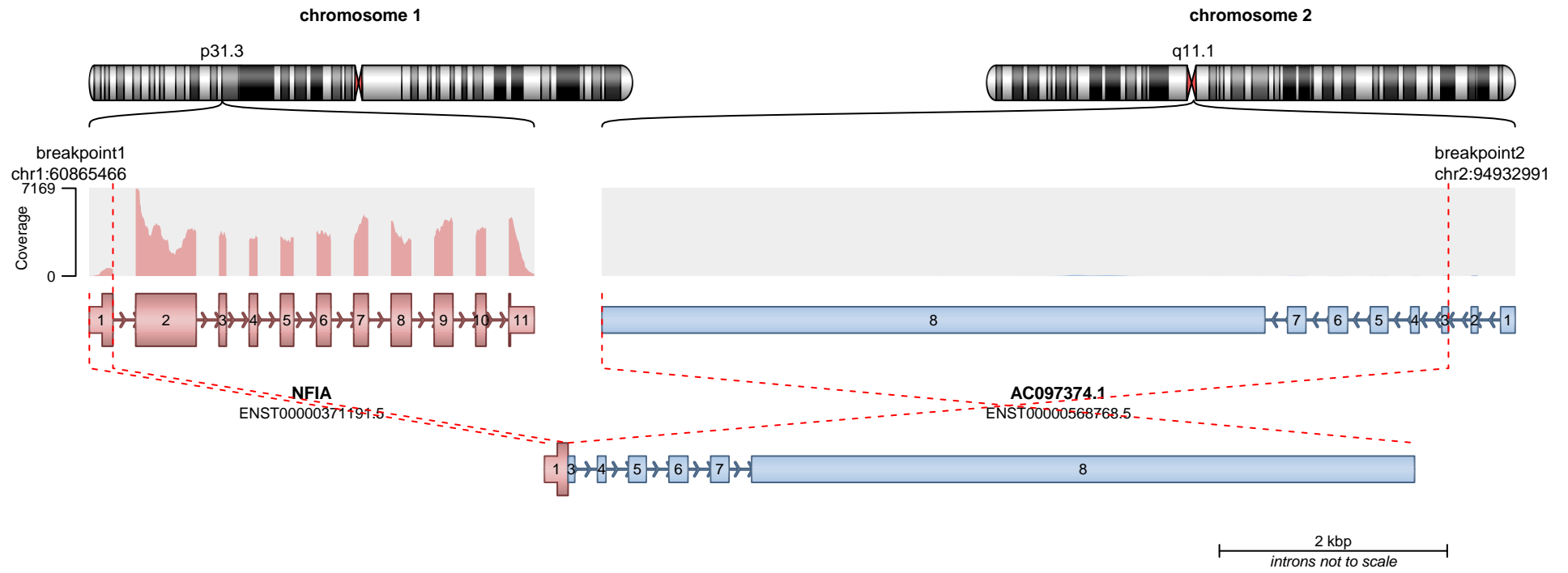

— translocation — deletion
— duplication — inversion

No protein domains retained in fusion.

SUPPORTING READ COUNT

Split reads = 5
Discordant mates = 0

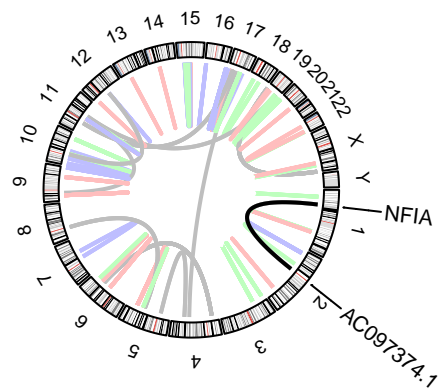
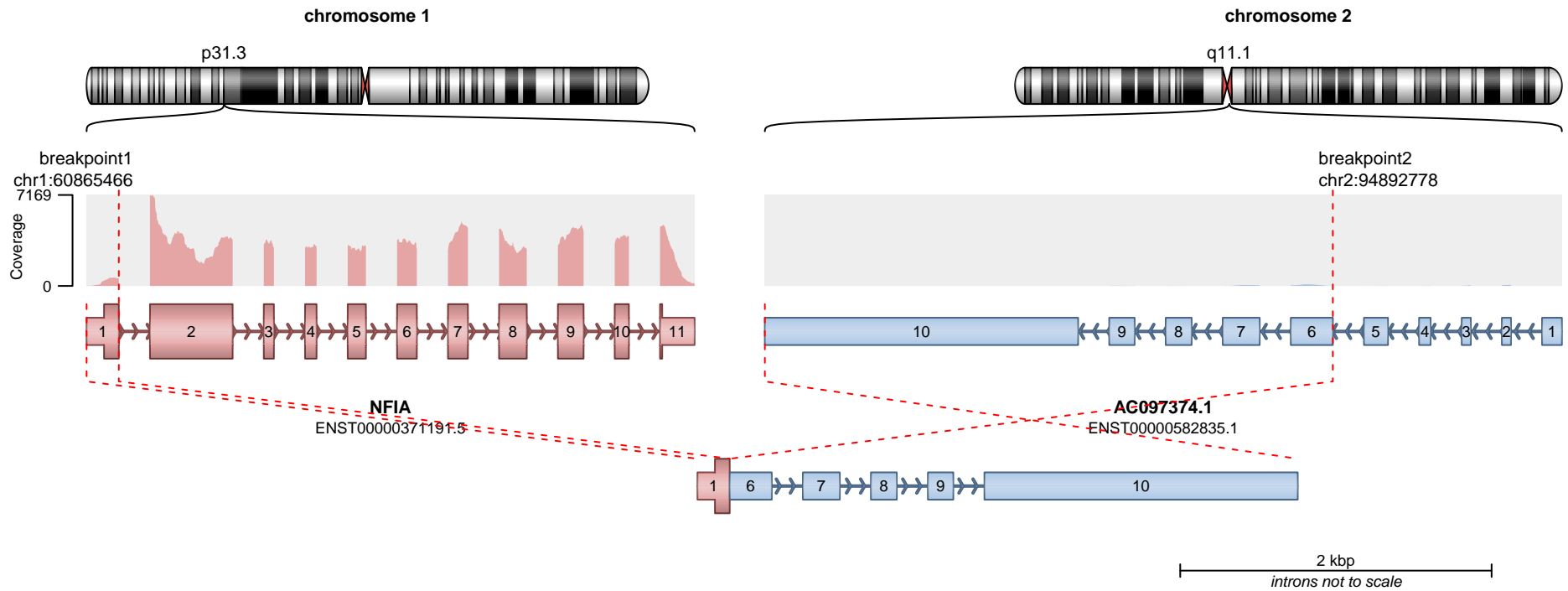

— translocation — deletion
— duplication — inversion

No protein domains retained in fusion.

SUPPORTING READ COUNT

Split reads = 1
Discordant mates = 0

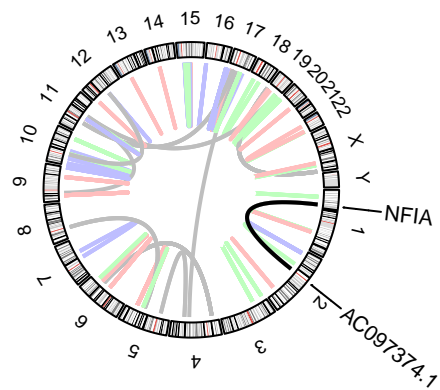
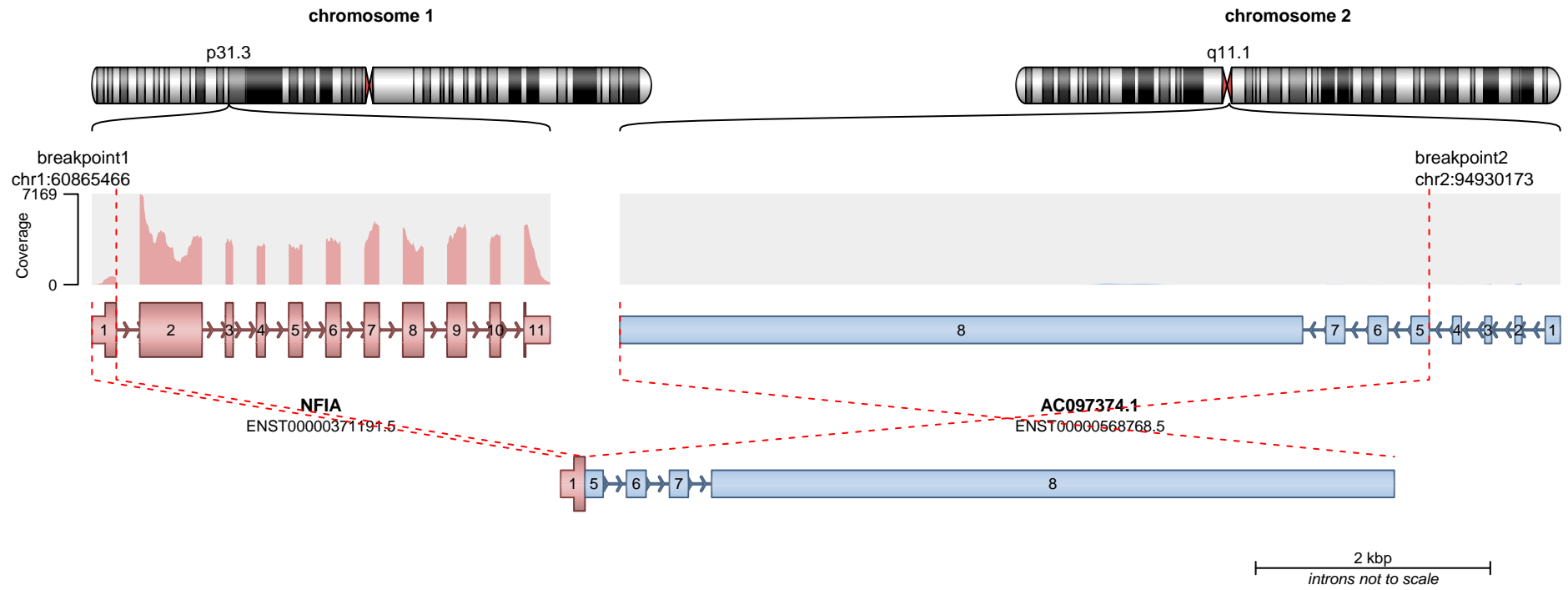

— translocation — deletion
— duplication — inversion

No protein domains retained in fusion.

SUPPORTING READ COUNT

Split reads = 1
Discordant mates = 0

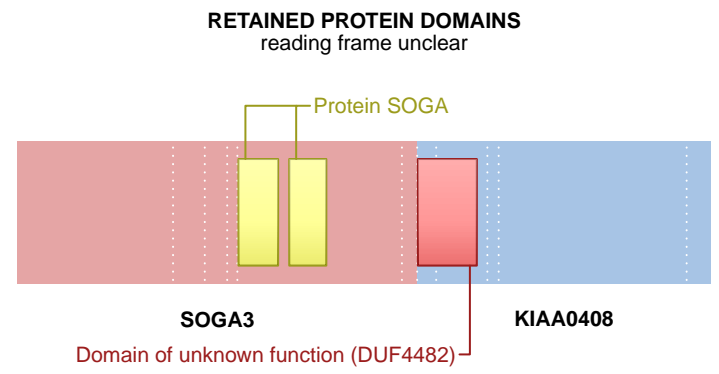
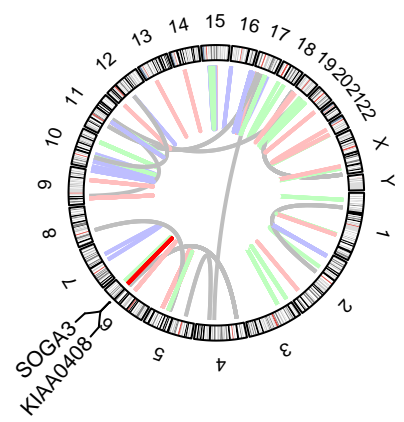
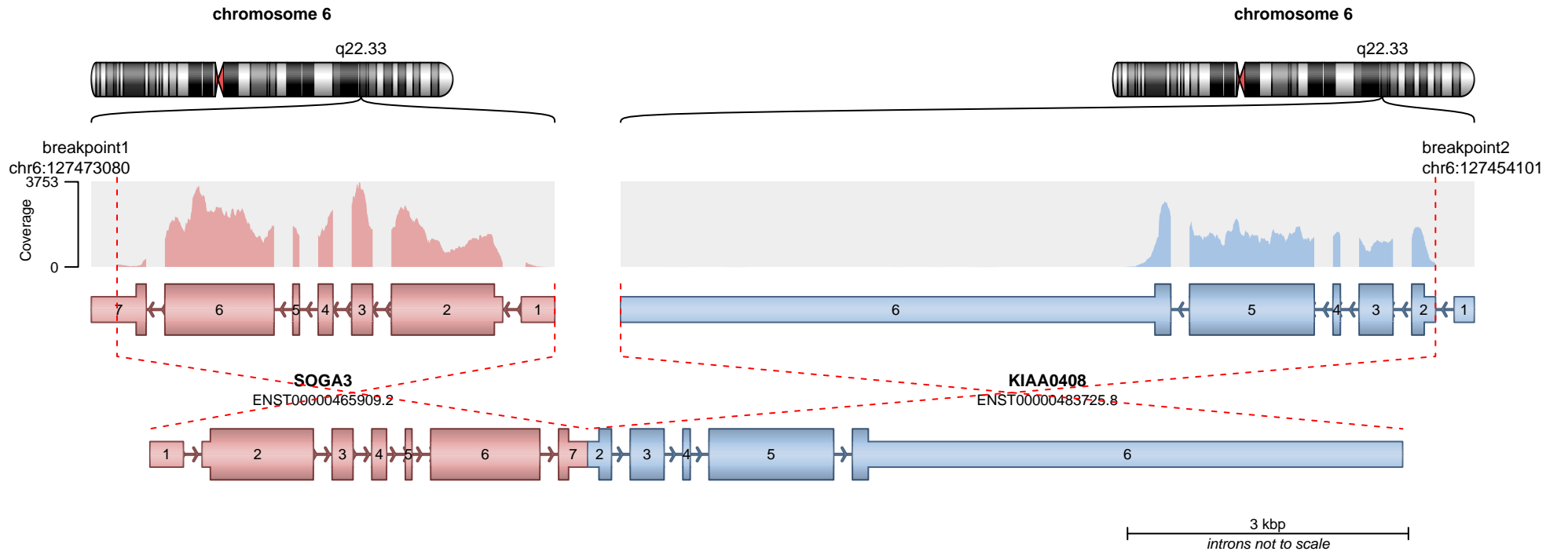

SUPPORTING READ COUNT

Split reads = 54
Discordant mates = 7

— translocation — deletion
— duplication — inversion

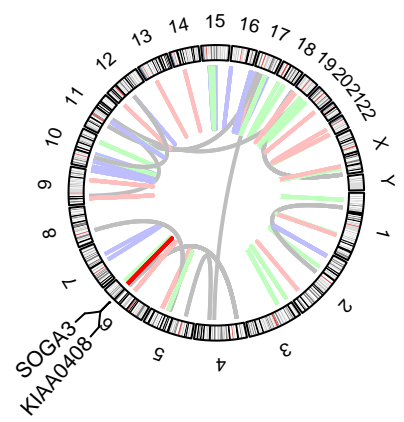
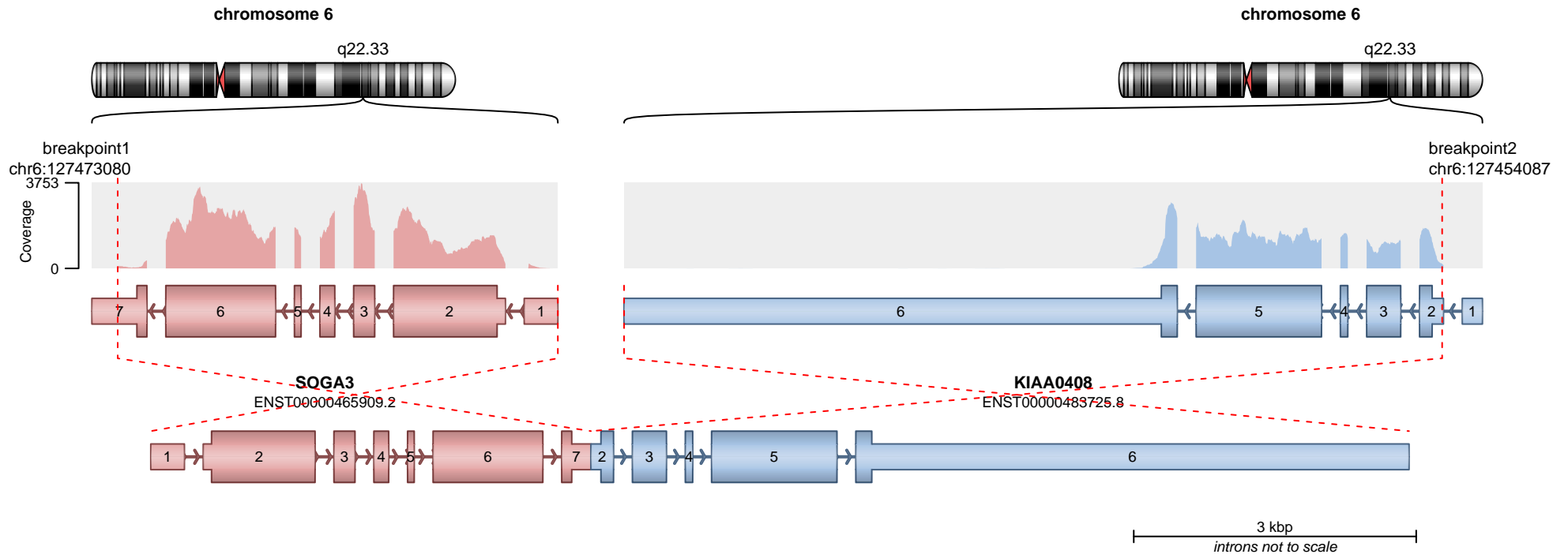

RETAINED PROTEIN DOMAINS
reading frame unclear

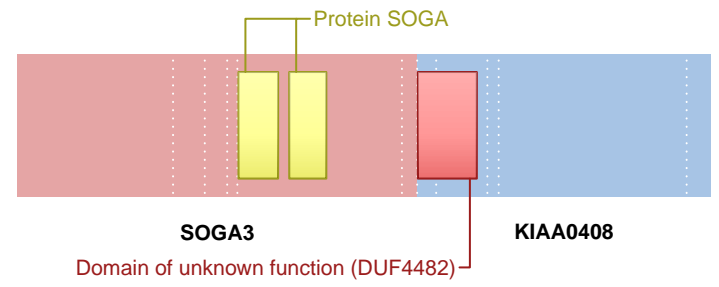

SUPPORTING READ COUNT

Split reads = 11
Discordant mates = 6

- translocation
- duplication
- deletion
- inversion

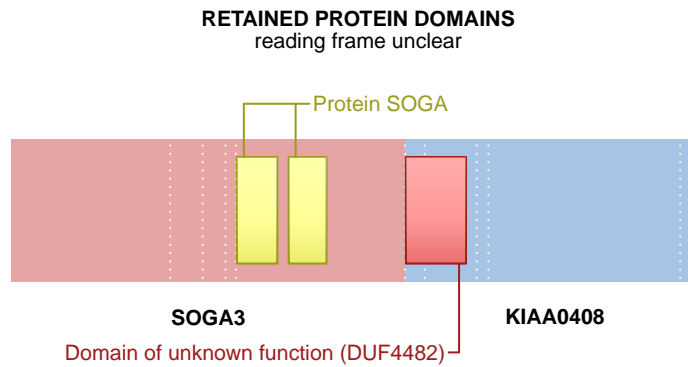
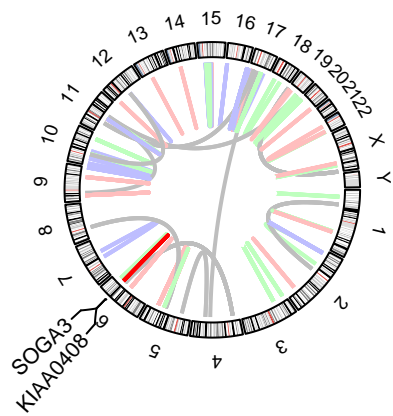
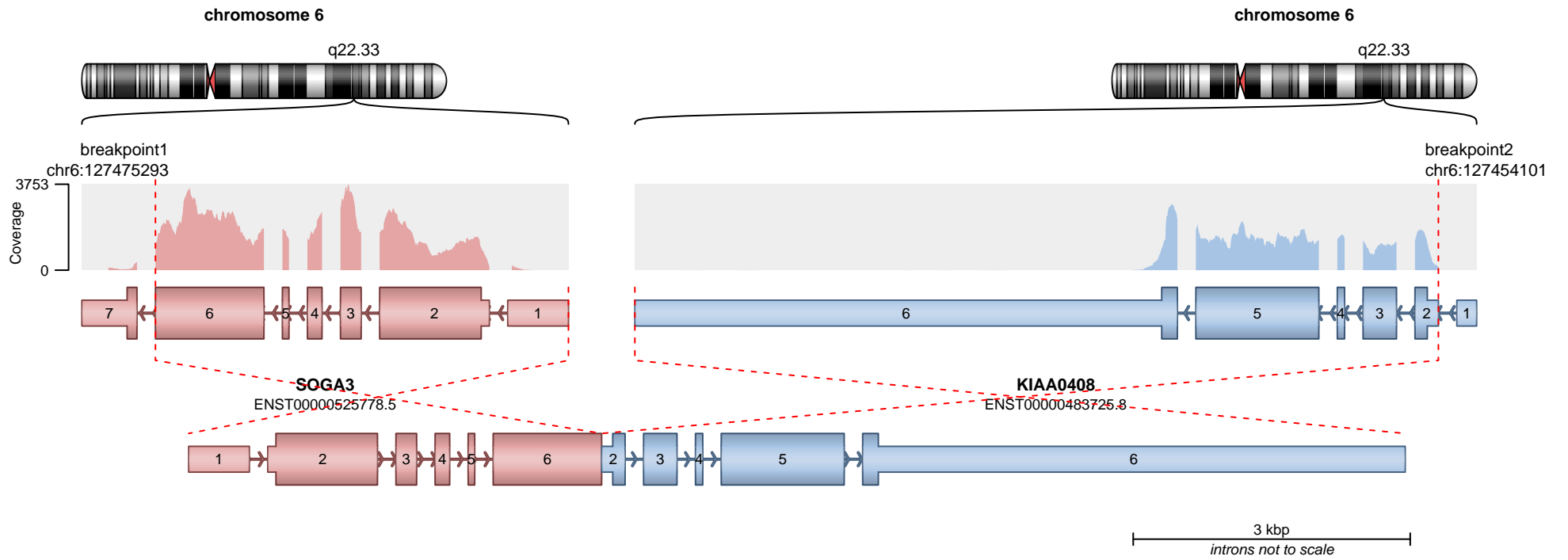

SUPPORTING READ COUNT

Split reads = 1
Discordant mates = 1

— translocation — deletion
— duplication — inversion

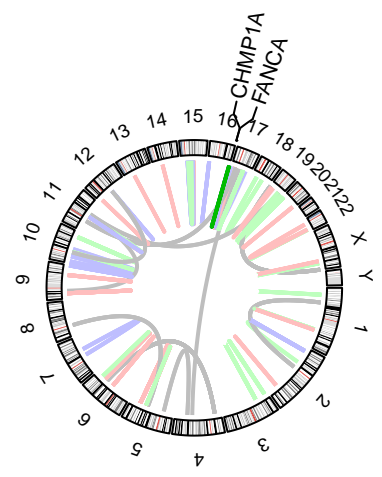
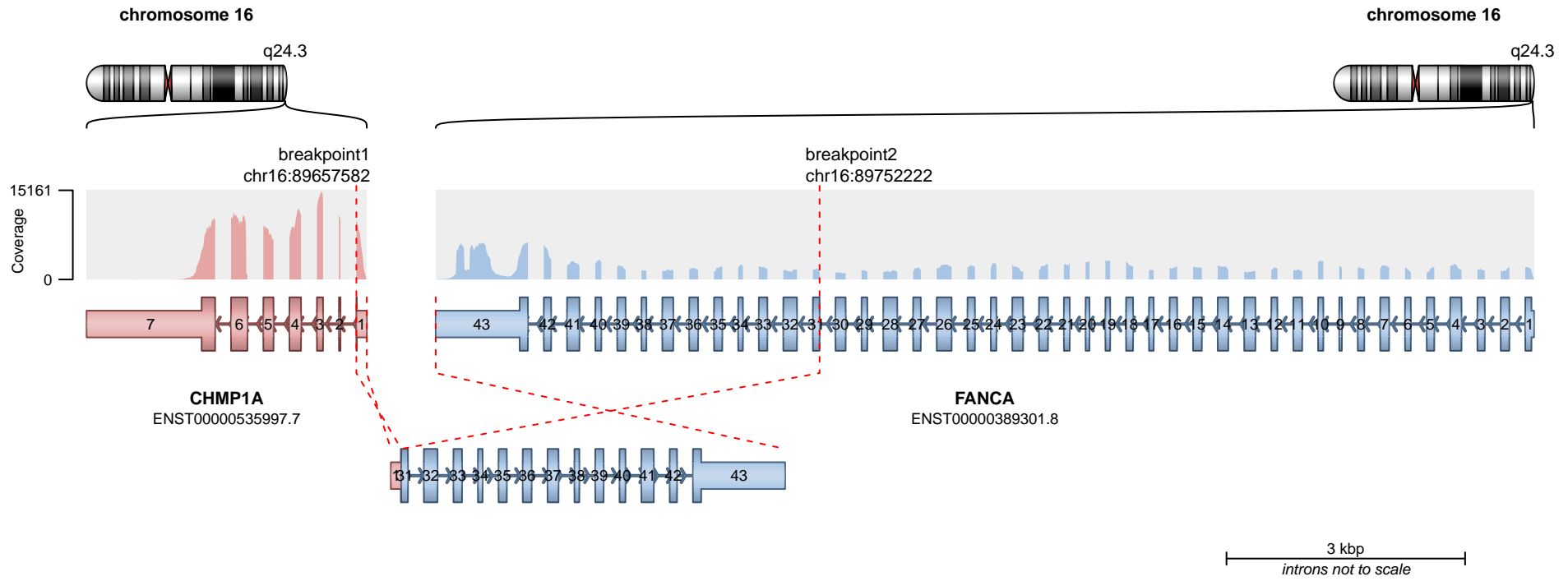

RETAINED PROTEIN DOMAINS
reading frame unclear

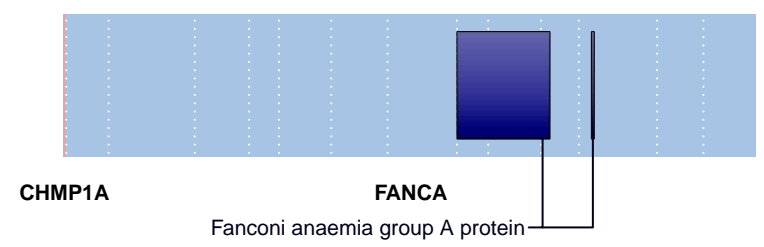

SUPPORTING READ COUNT

Split reads = 54
Discordant mates = 0

- translocation
- duplication
- deletion
- inversion

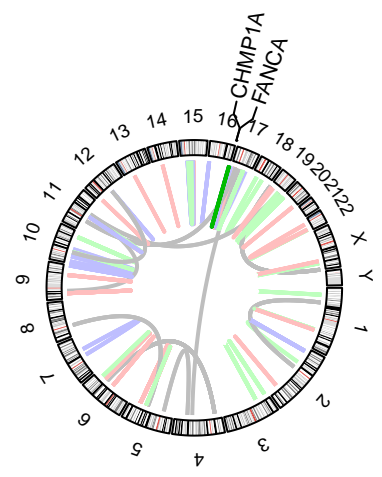
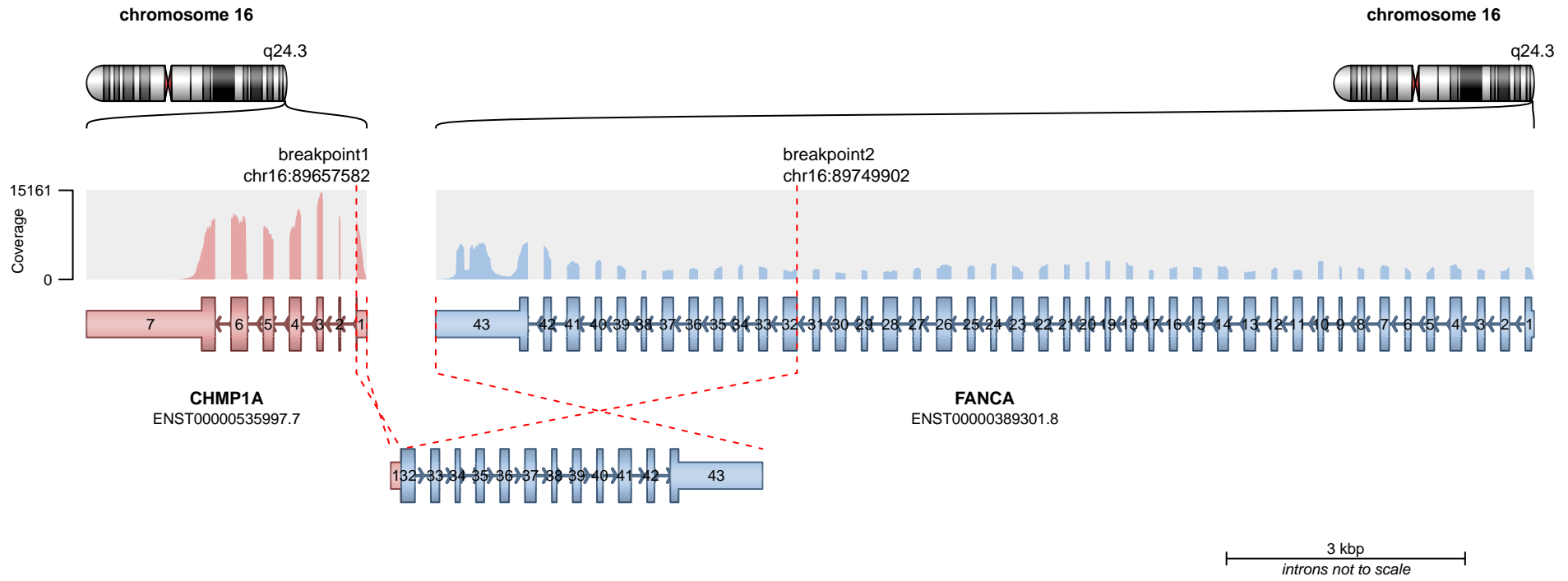

RETAINED PROTEIN DOMAINS
reading frame unclear

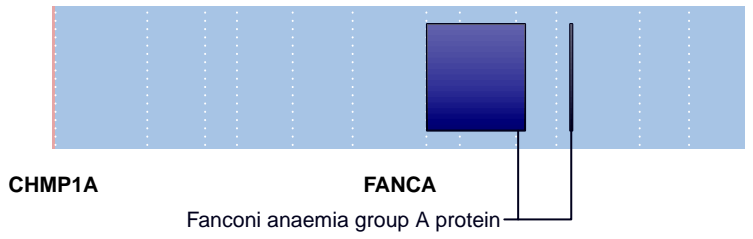

SUPPORTING READ COUNT

Split reads = 4
Discordant mates = 0

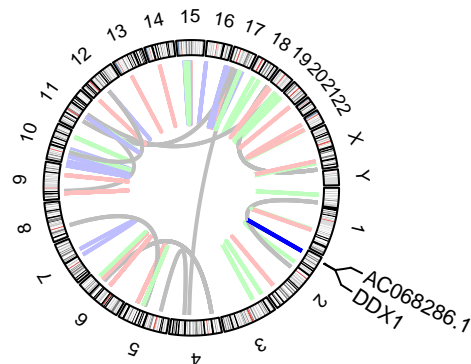
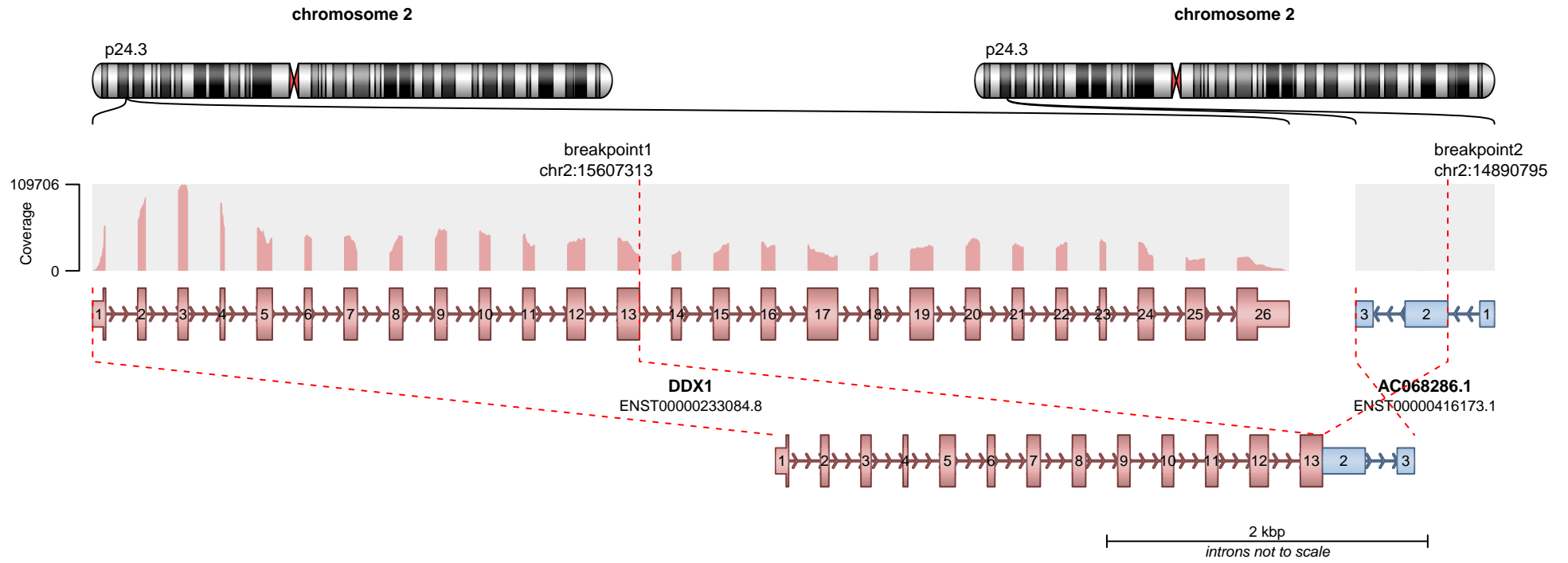

RETAINED PROTEIN DOMAINS
reading frame unclear

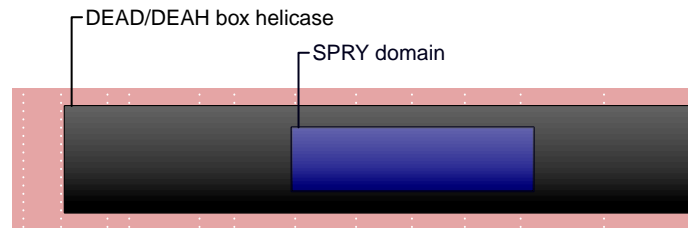

SUPPORTING READ COUNT

Split reads = 46
Discordant mates = 16

- translocation
- duplication
- deletion
- inversion

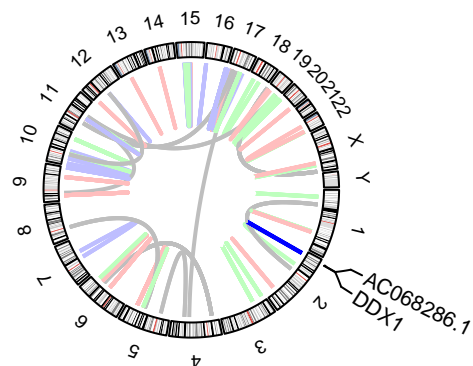
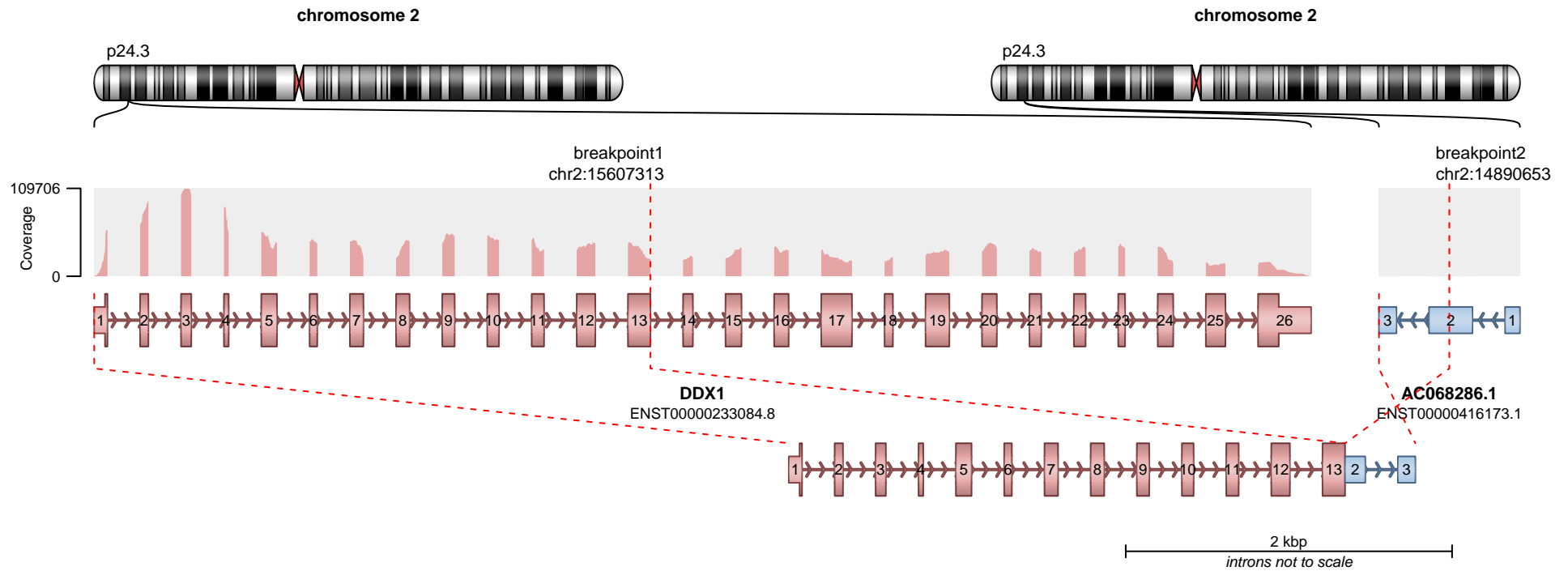

RETAINED PROTEIN DOMAINS
reading frame unclear

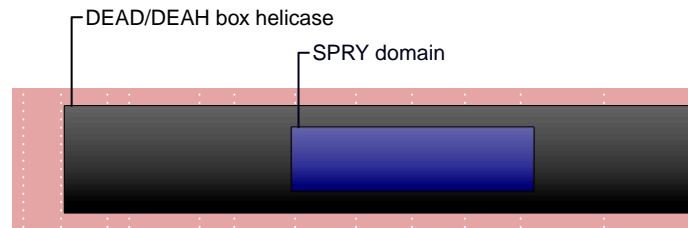

SUPPORTING READ COUNT

Split reads = 46
Discordant mates = 5

- translocation
- duplication
- deletion
- inversion

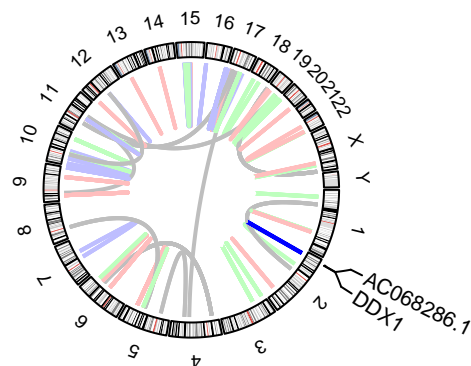
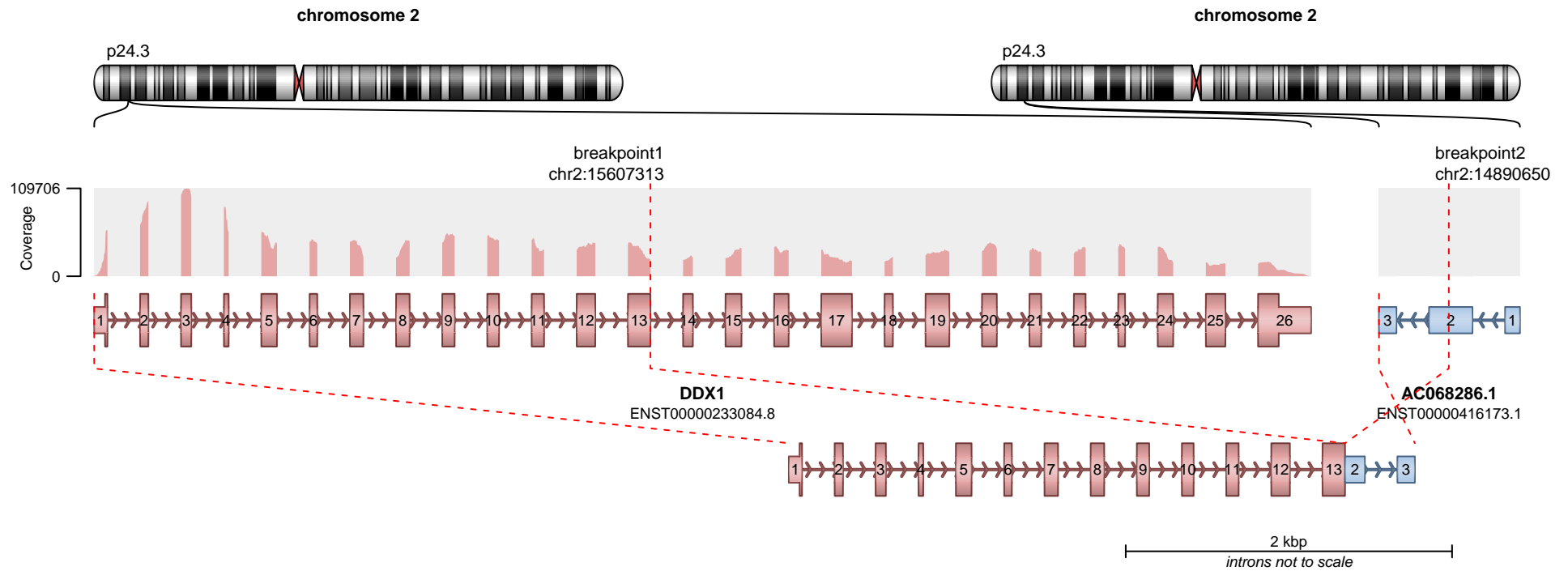

RETAINED PROTEIN DOMAINS
reading frame unclear

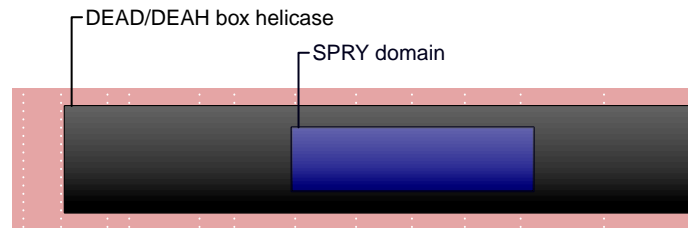

SUPPORTING READ COUNT

Split reads = 31
Discordant mates = 4

- translocation
- duplication
- deletion
- inversion

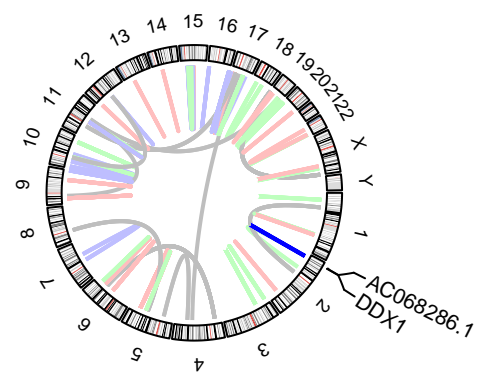
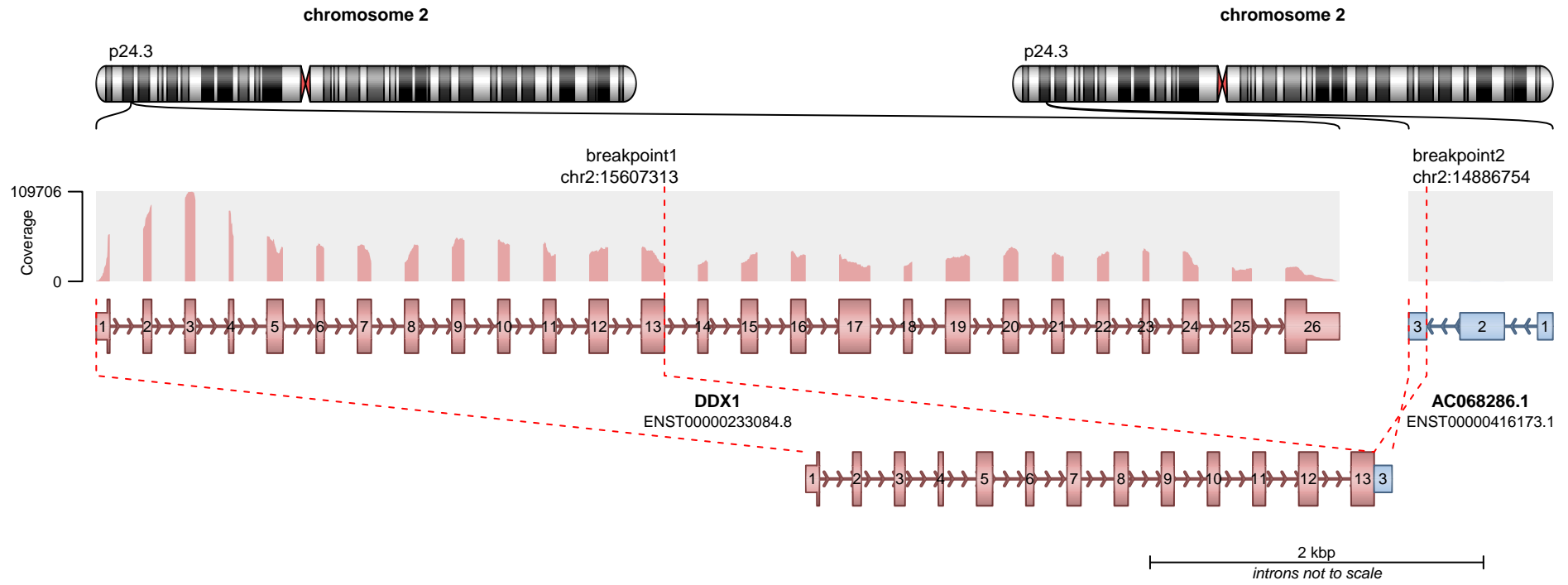

RETAINED PROTEIN DOMAINS
reading frame unclear

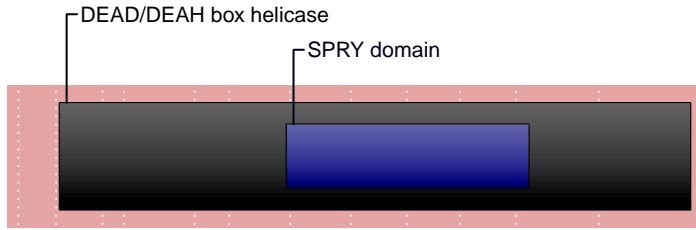

SUPPORTING READ COUNT

Split reads = 21
Discordant mates = 0

- translocation
- duplication
- deletion
- inversion

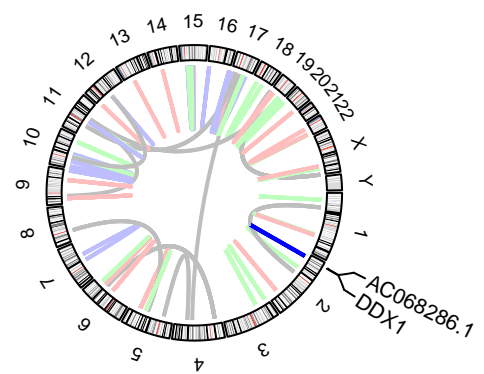
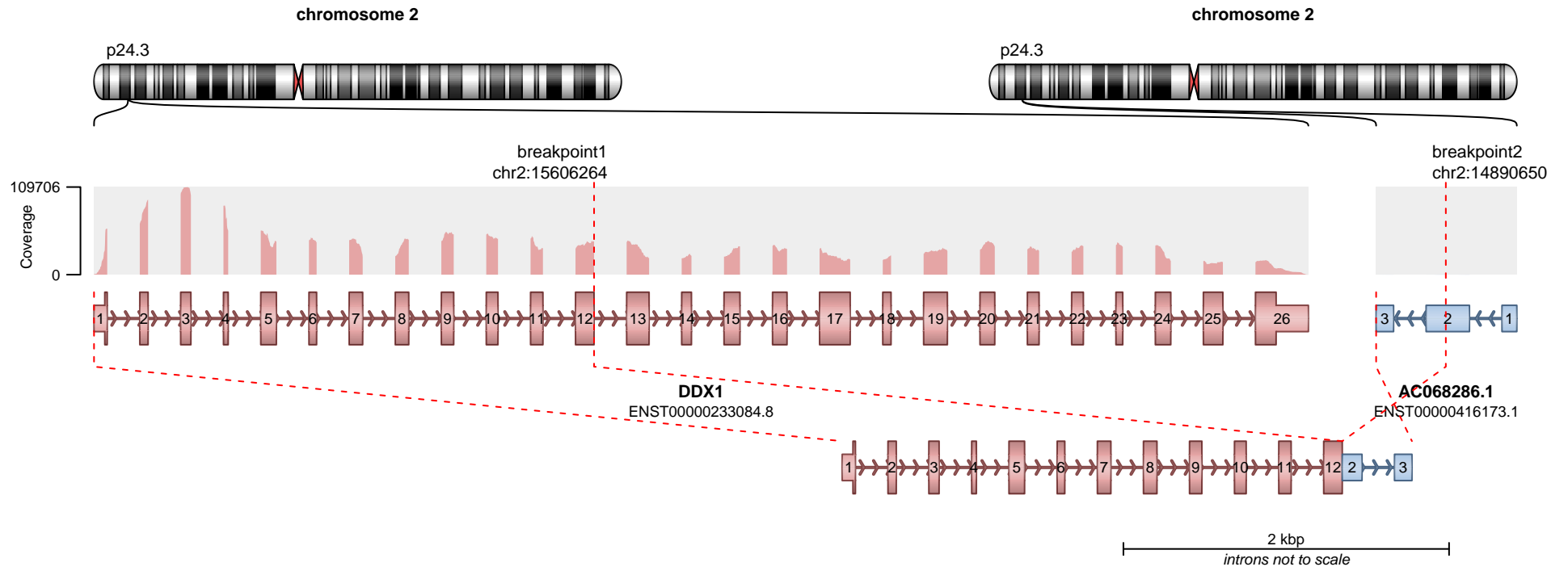

RETAINED PROTEIN DOMAINS
reading frame unclear

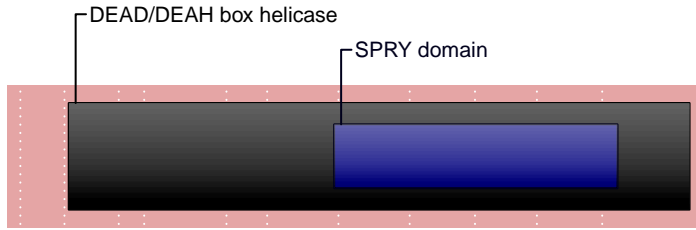

SUPPORTING READ COUNT

Split reads = 4
Discordant mates = 0

- translocation
- duplication
- deletion
- inversion

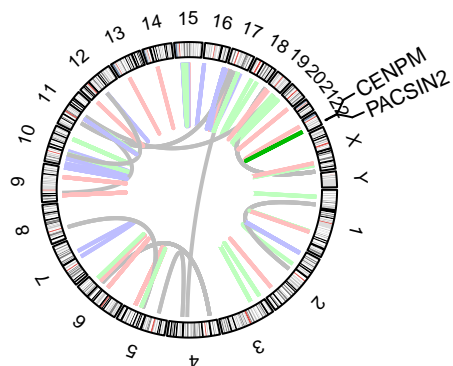
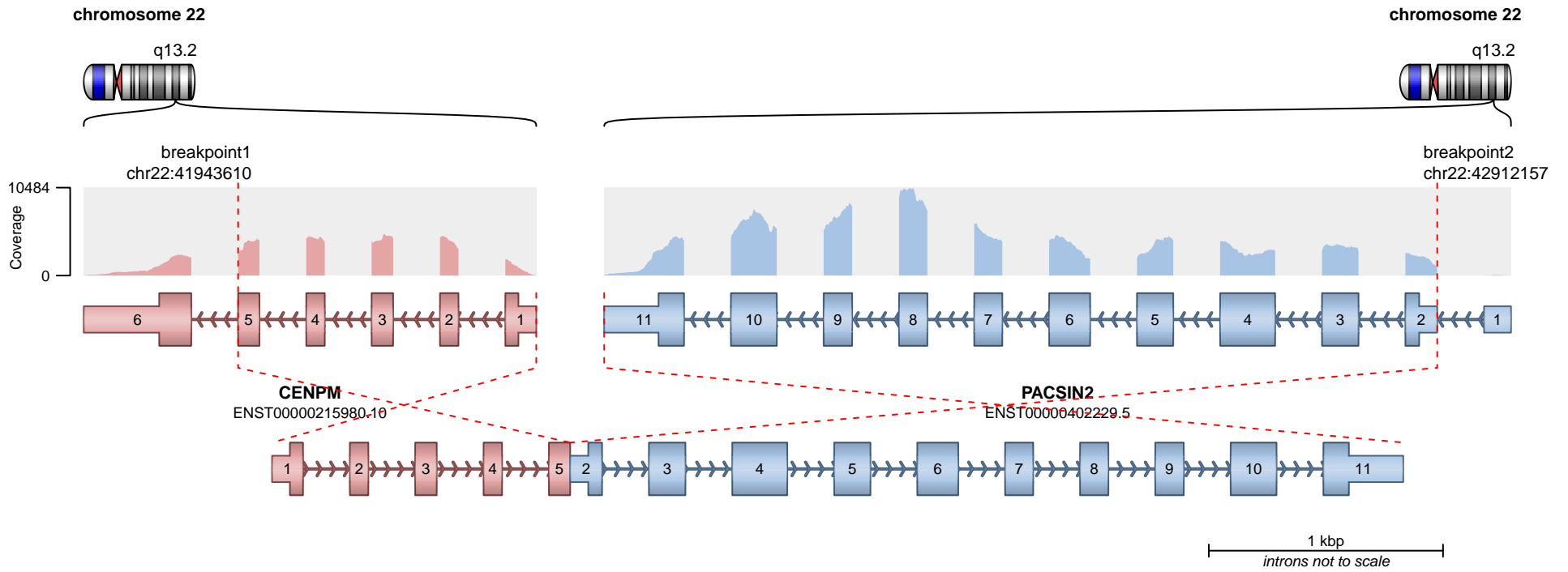

RETAINED PROTEIN DOMAINS
reading frame unclear

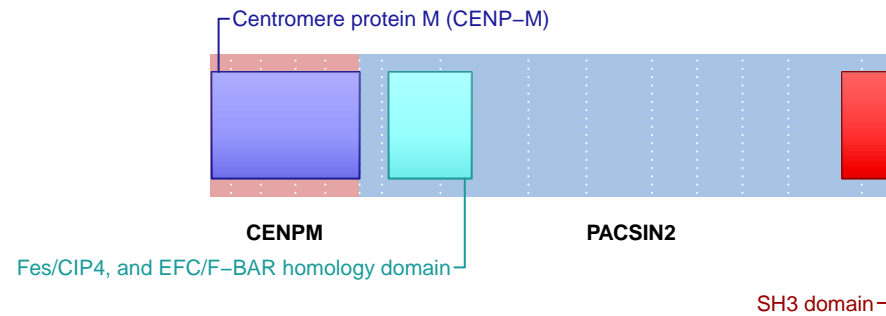

SUPPORTING READ COUNT

Split reads = 46
Discordant mates = 3

— translocation — deletion
— duplication — inversion

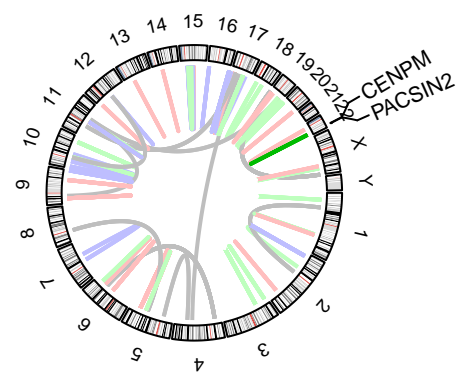
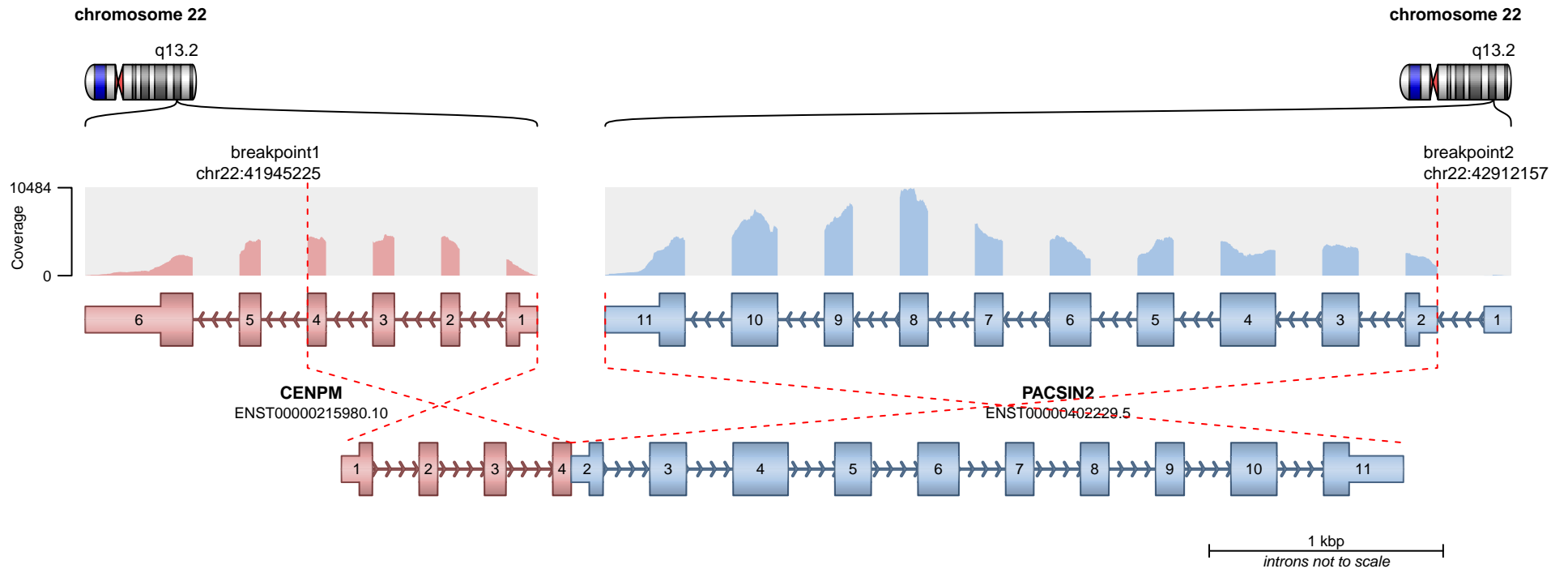

RETAINED PROTEIN DOMAINS
reading frame unclear

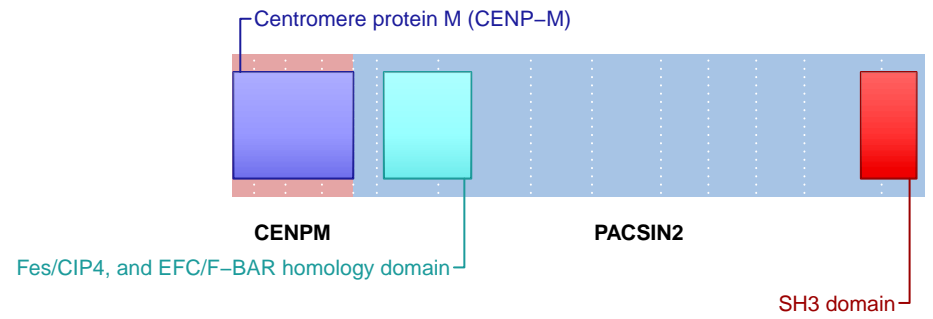

SUPPORTING READ COUNT

Split reads = 7
Discordant mates = 1

- translocation
- duplication
- deletion
- inversion

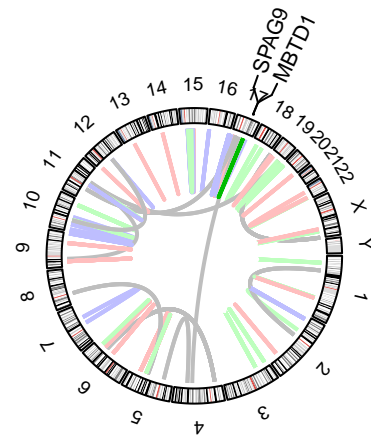
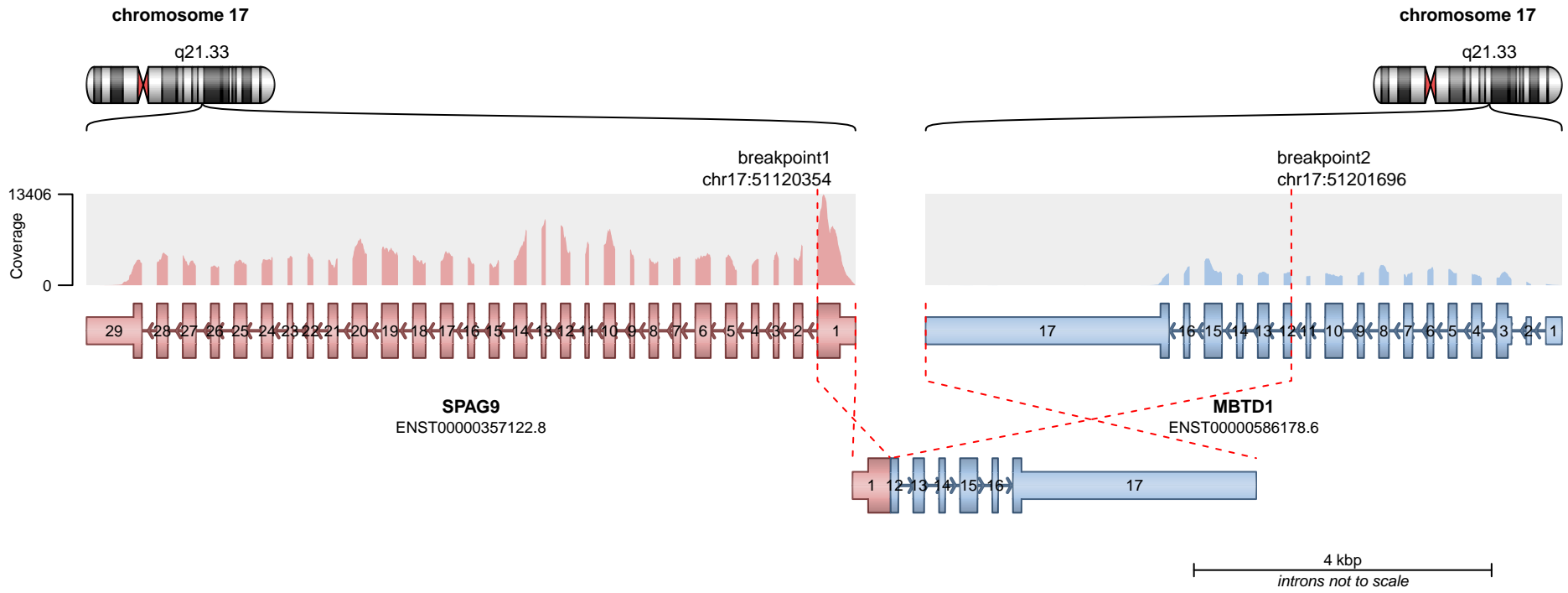

RETAINED PROTEIN DOMAINS
reading frame unclear

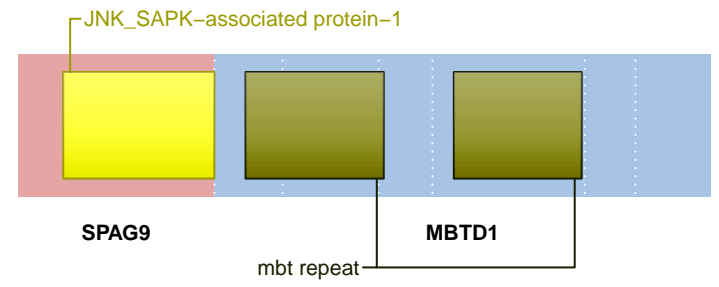

SUPPORTING READ COUNT

Split reads = 44
Discordant mates = 0

- translocation
- duplication
- deletion
- inversion

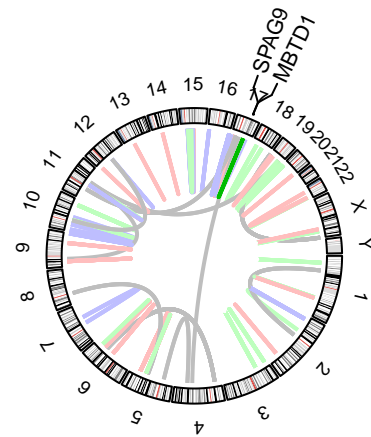
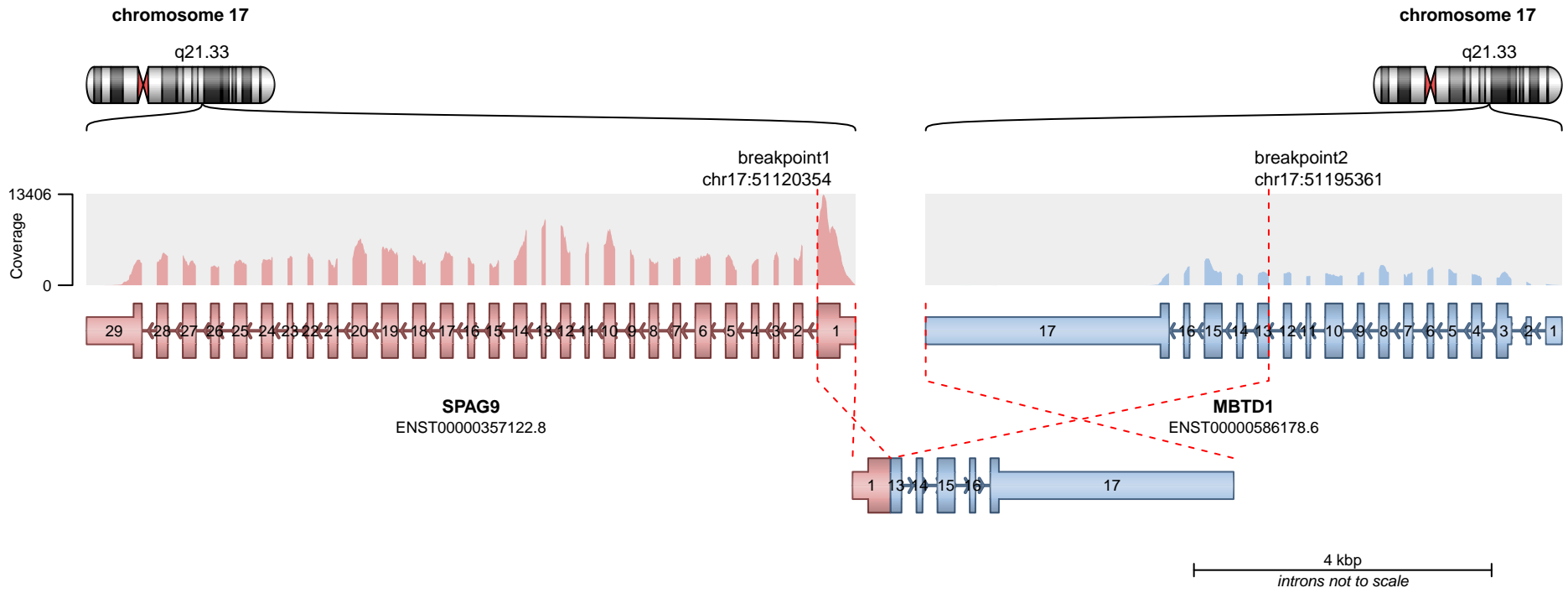

RETAINED PROTEIN DOMAINS
reading frame unclear

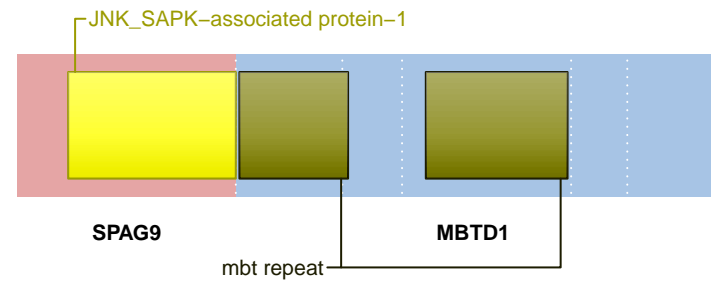

SUPPORTING READ COUNT

Split reads = 5
Discordant mates = 0

— translocation — deletion
— duplication — inversion

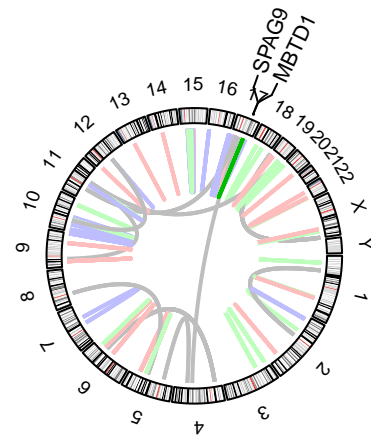
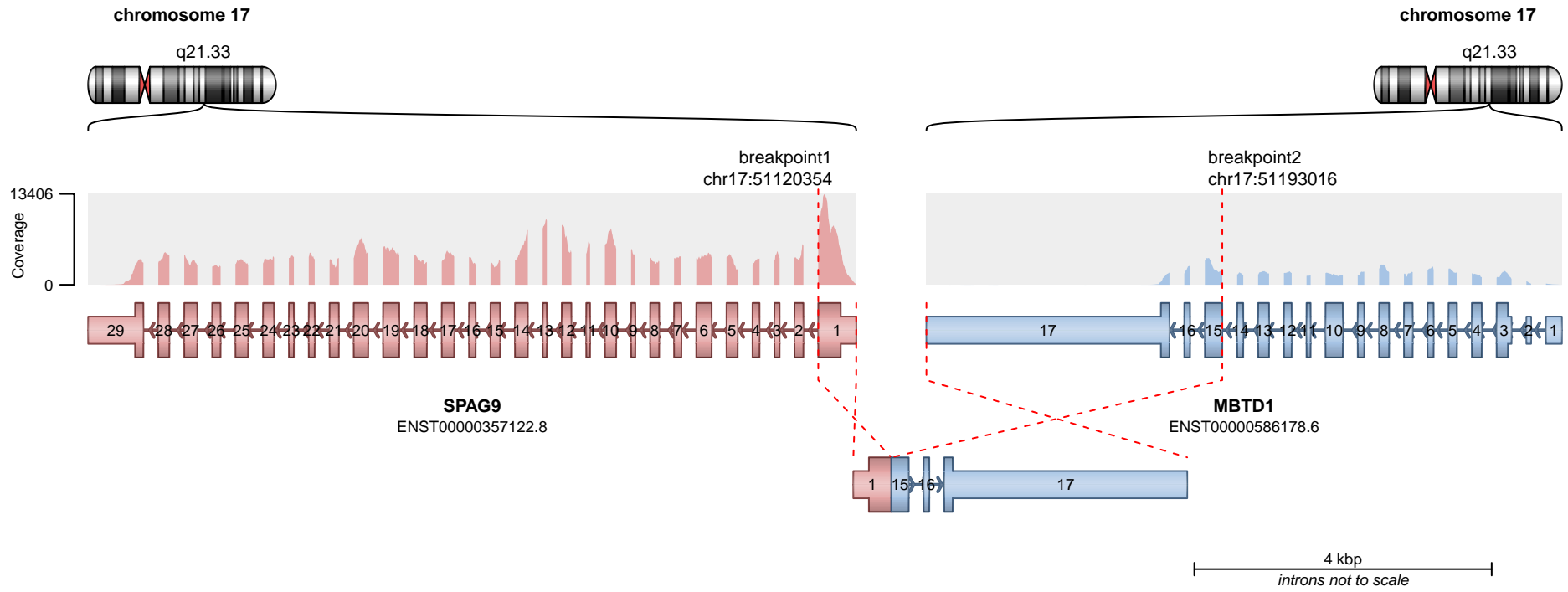

RETAINED PROTEIN DOMAINS
reading frame unclear

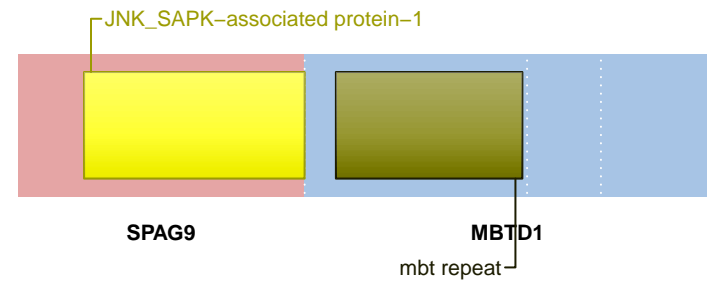

SUPPORTING READ COUNT

Split reads = 4
Discordant mates = 0

- translocation
- duplication
- deletion
- inversion

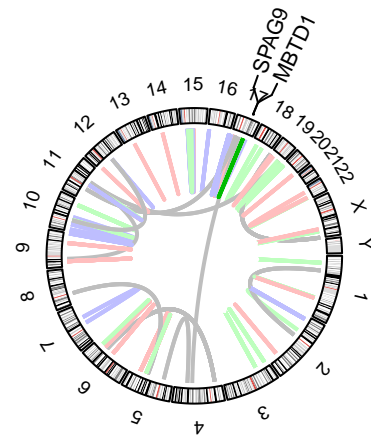
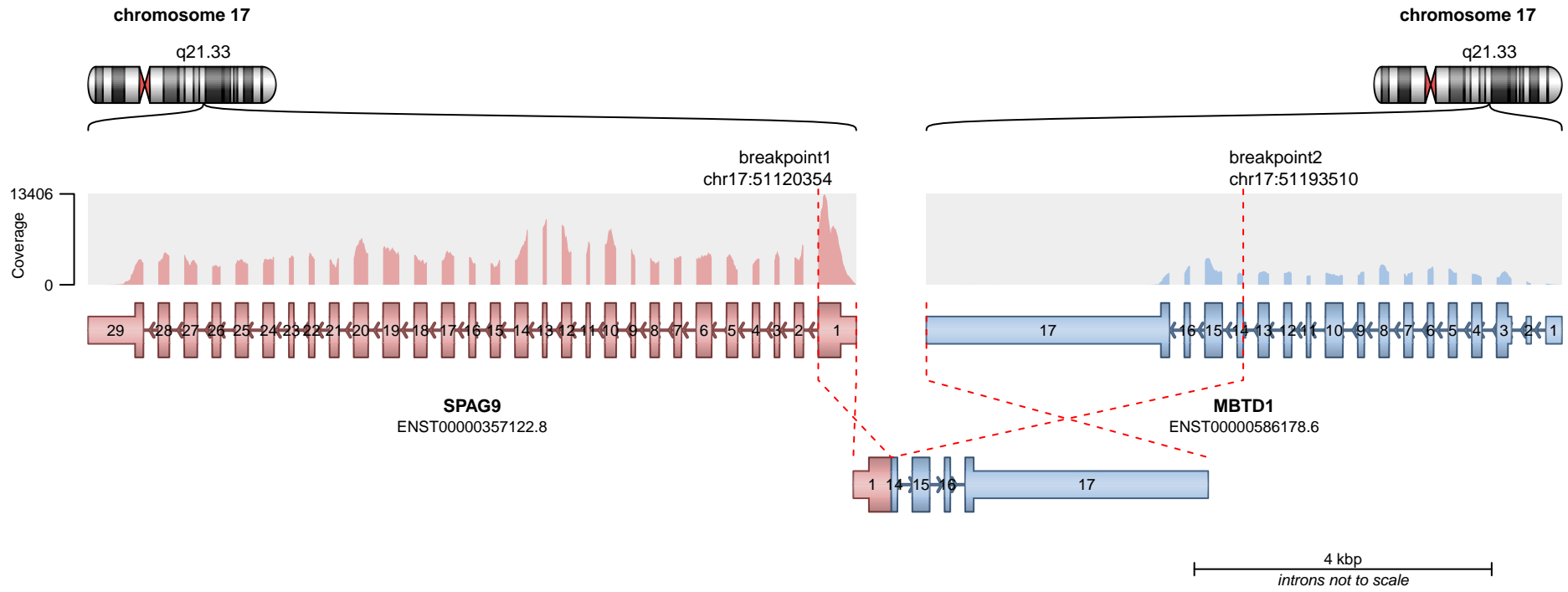

RETAINED PROTEIN DOMAINS
reading frame unclear

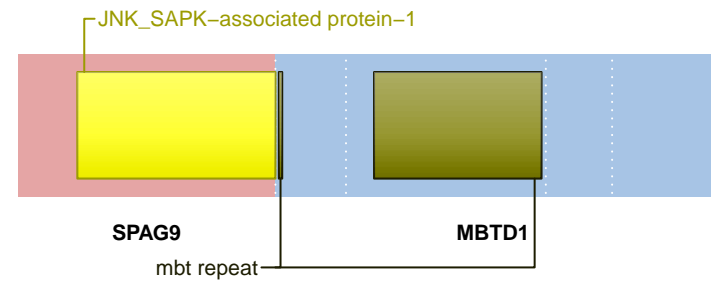

SUPPORTING READ COUNT

Split reads = 3
Discordant mates = 0

- translocation
- duplication
- deletion
- inversion

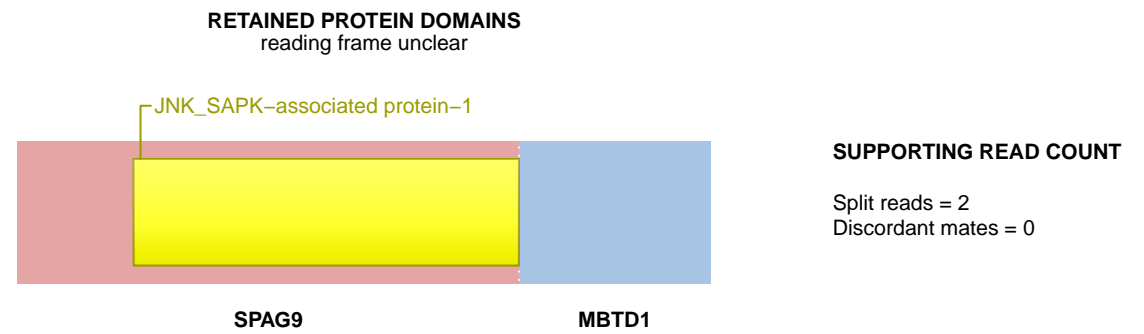
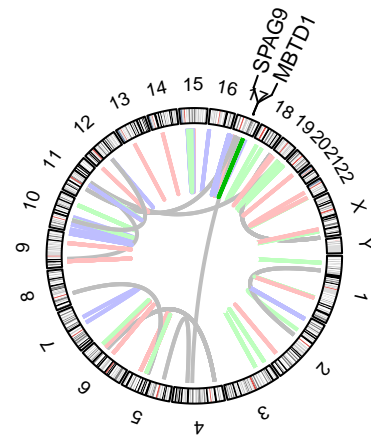
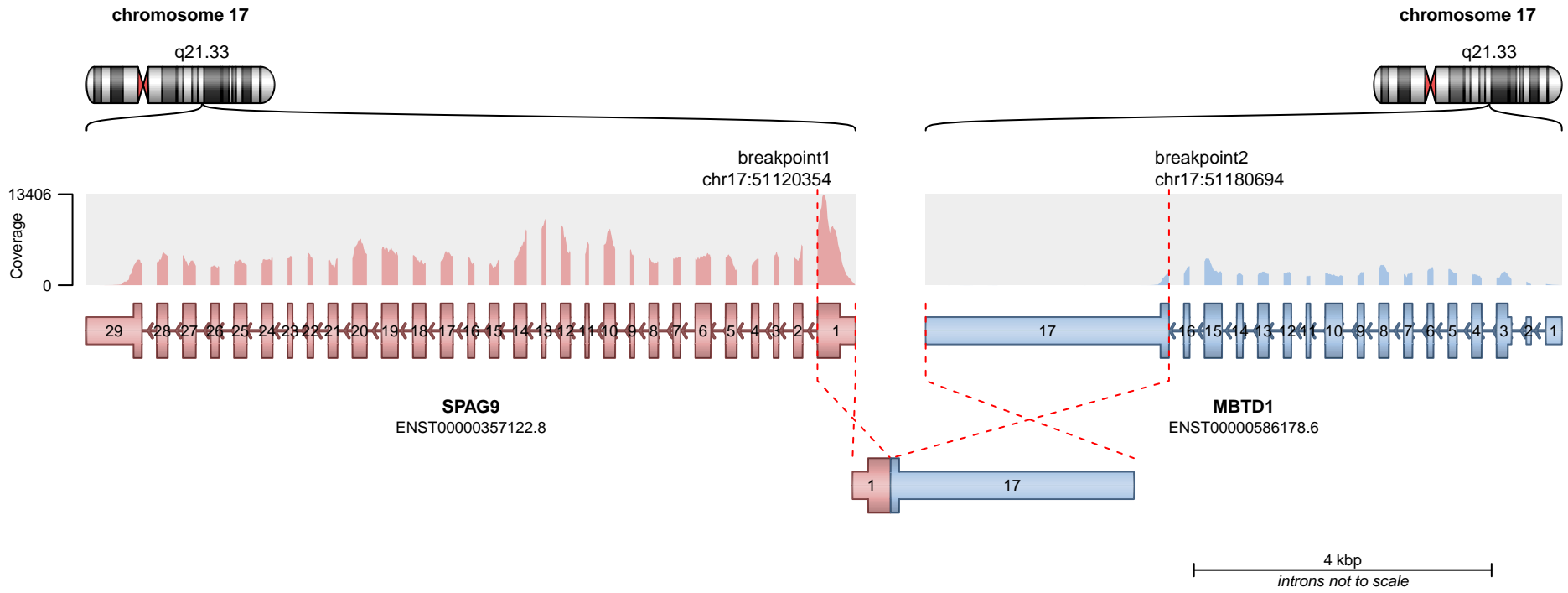

— translocation — deletion
— duplication — inversion

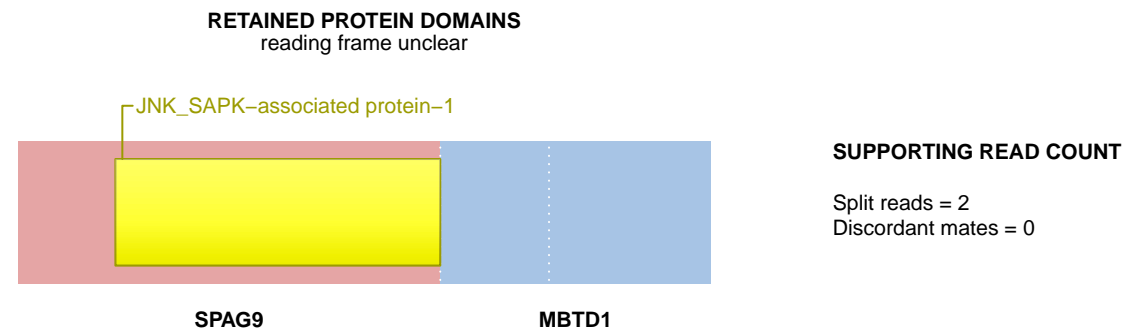
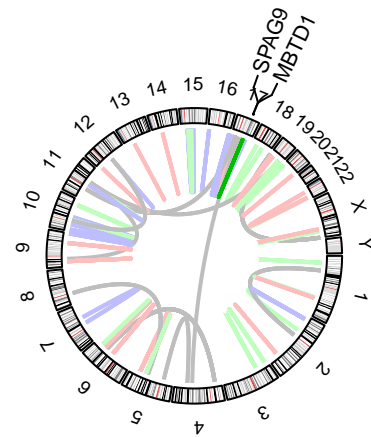
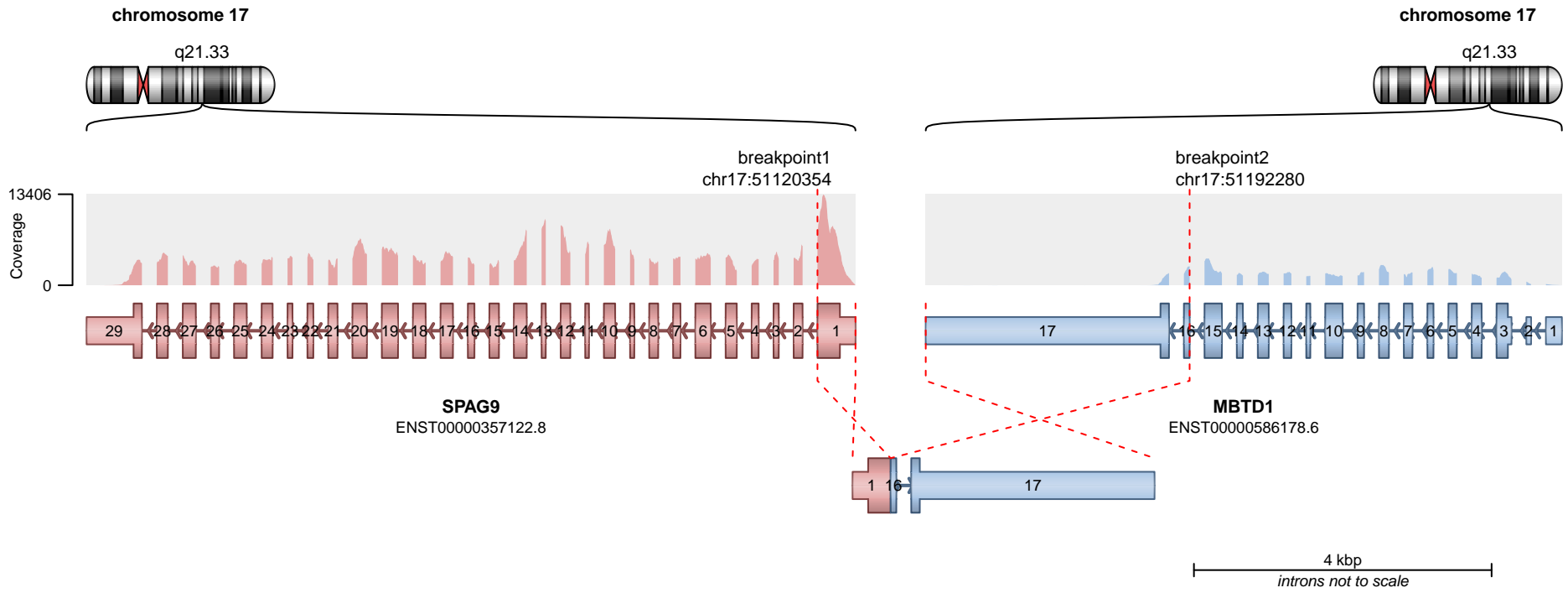

— translocation — deletion
— duplication — inversion

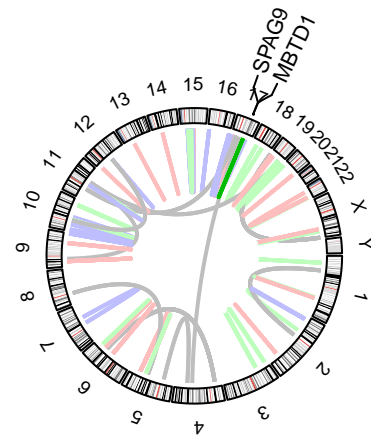
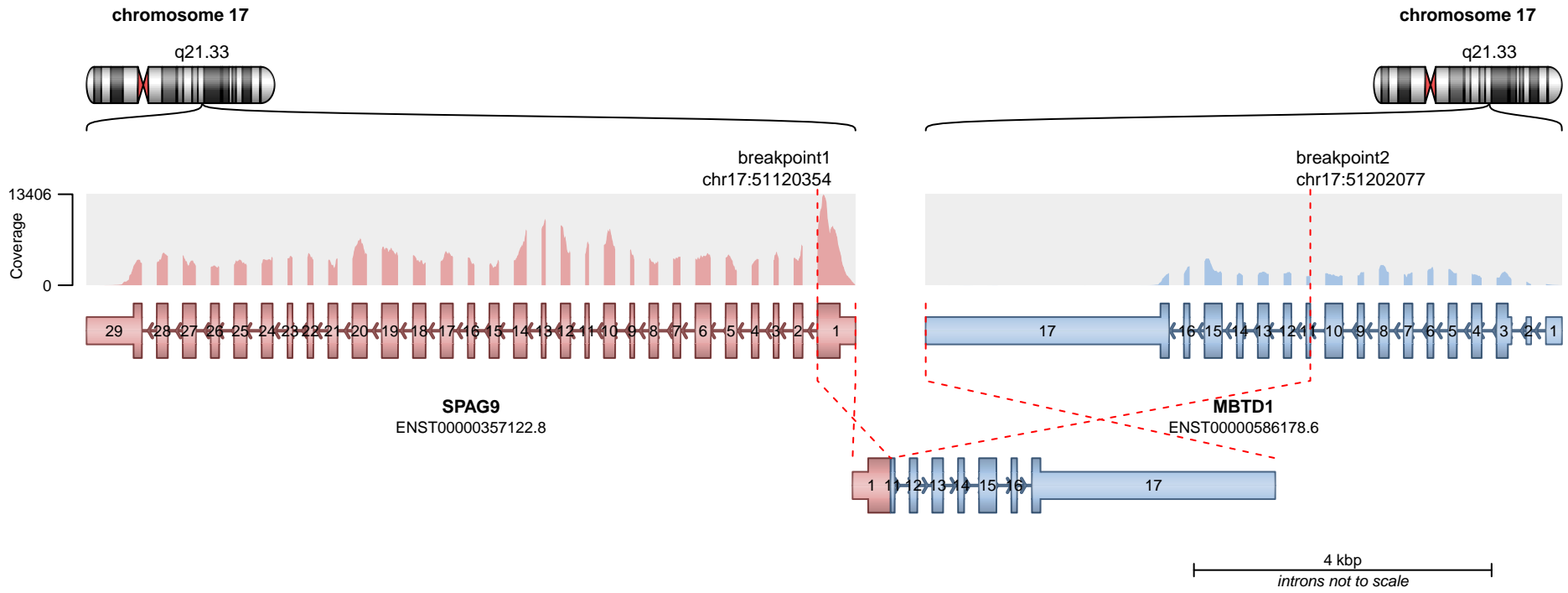

RETAINED PROTEIN DOMAINS
reading frame unclear

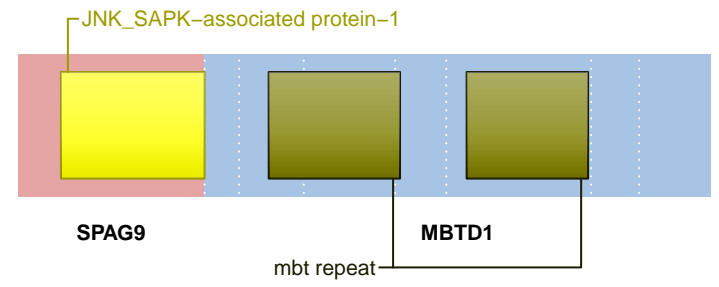

SUPPORTING READ COUNT

Split reads = 2
Discordant mates = 0

- translocation
- duplication
- deletion
- inversion

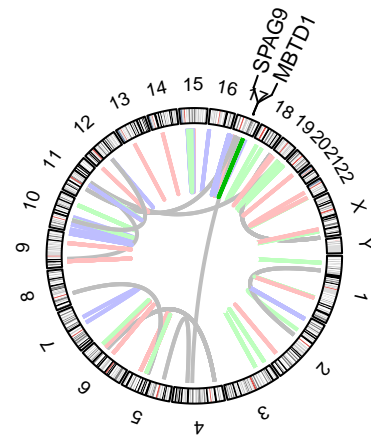
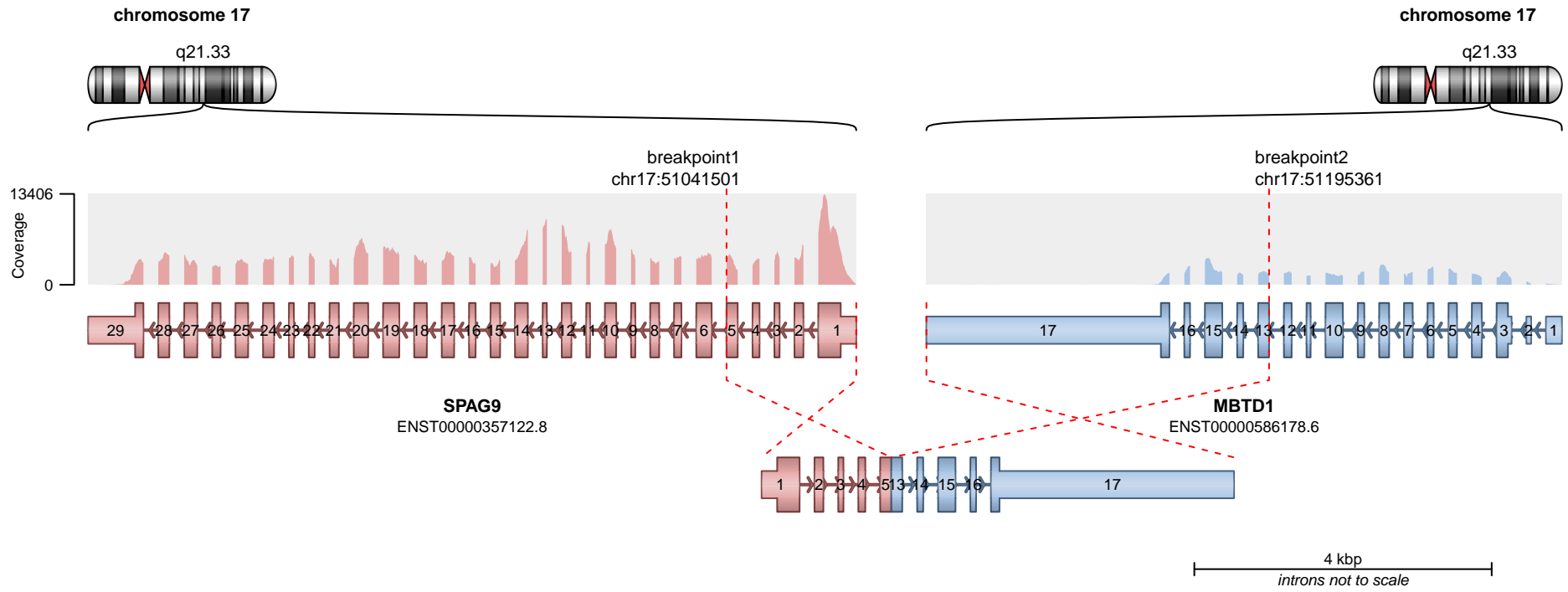

RETAINED PROTEIN DOMAINS
reading frame unclear

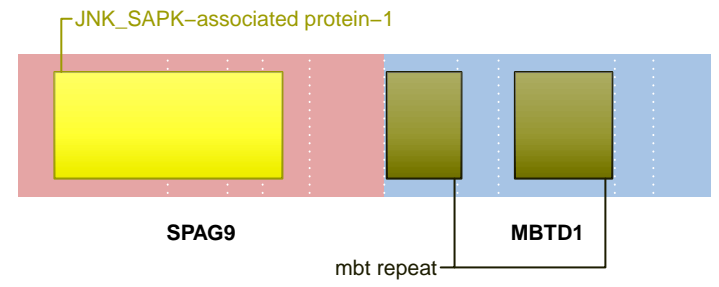

SUPPORTING READ COUNT

Split reads = 1
Discordant mates = 0

- translocation
- duplication
- deletion
- inversion

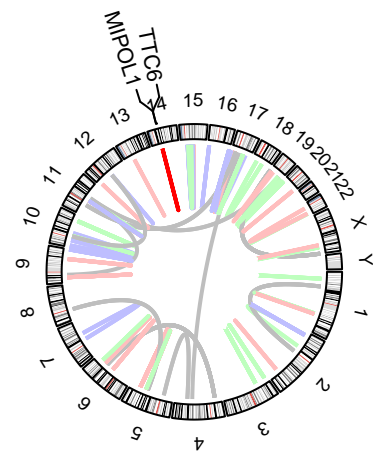
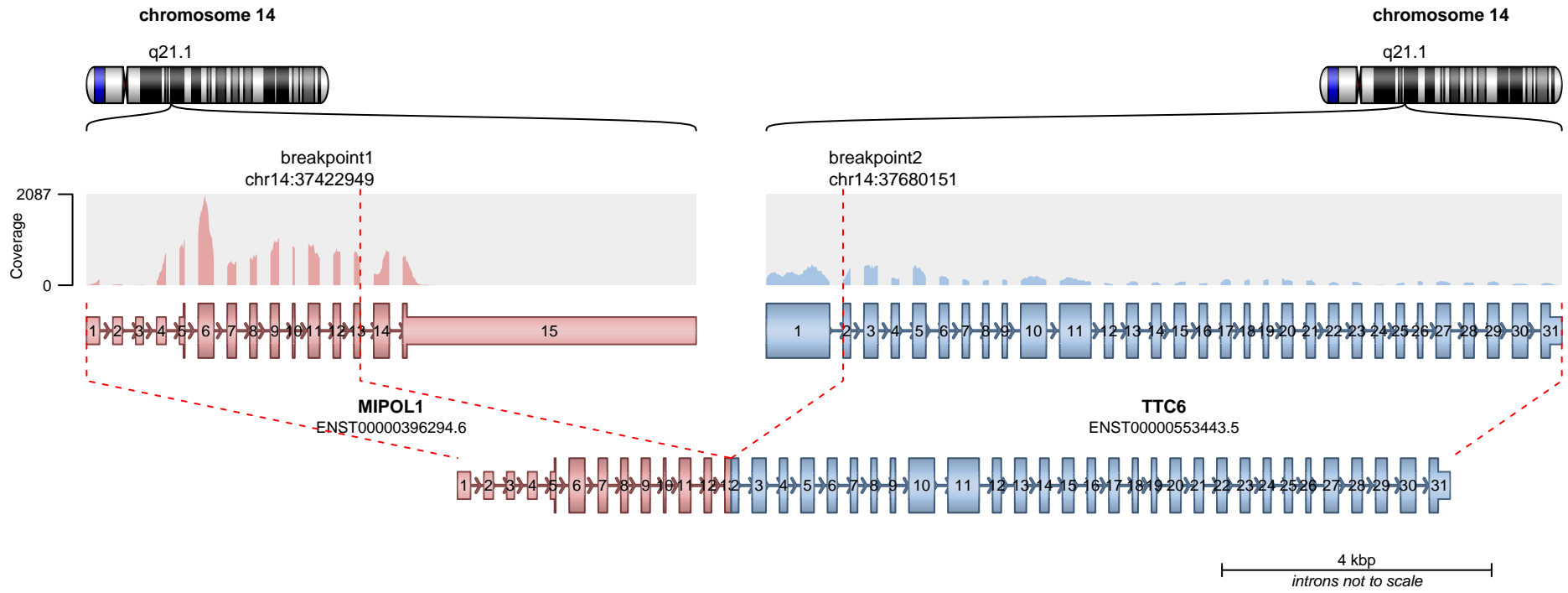

— translocation — deletion
— duplication — inversion

RETAINED PROTEIN DOMAINS
reading frame unclear

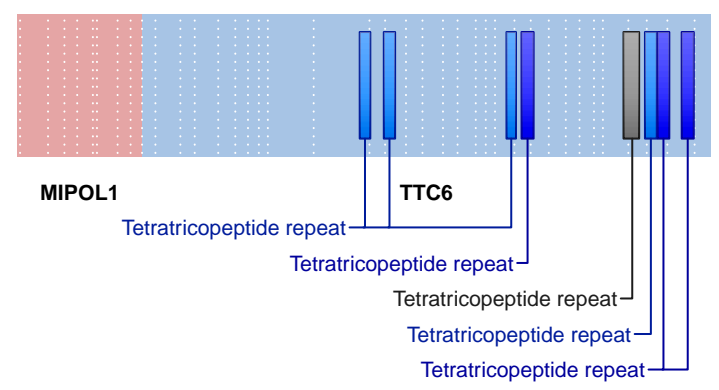

SUPPORTING READ COUNT

Split reads = 43
Discordant mates = 1

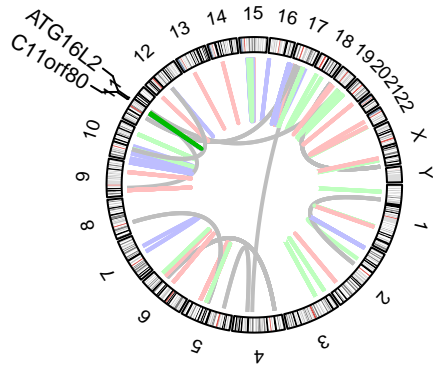
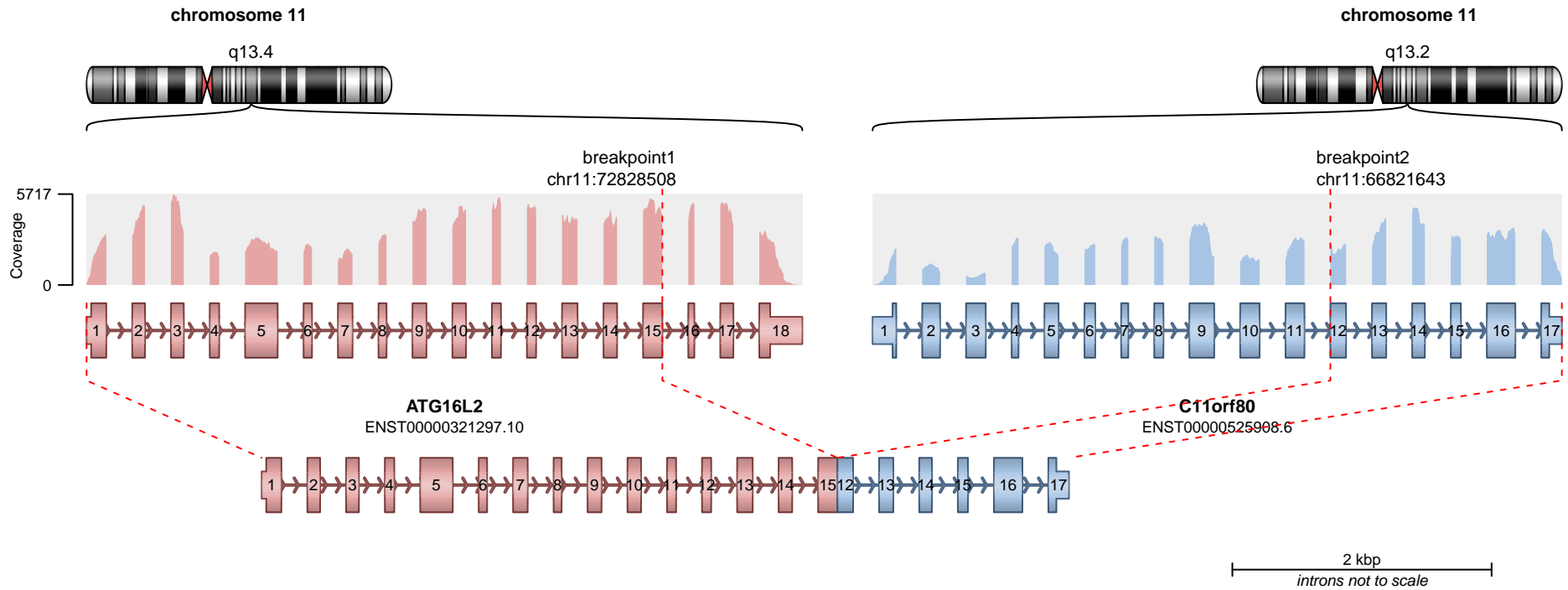

RETAINED PROTEIN DOMAINS
reading frame unclear

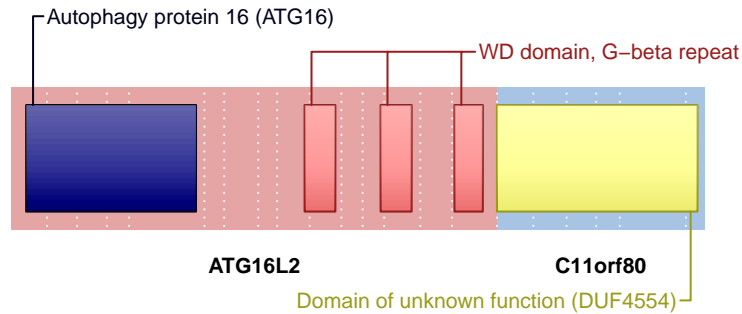

SUPPORTING READ COUNT

Split reads = 42
Discordant mates = 1

- translocation
- duplication
- deletion
- inversion

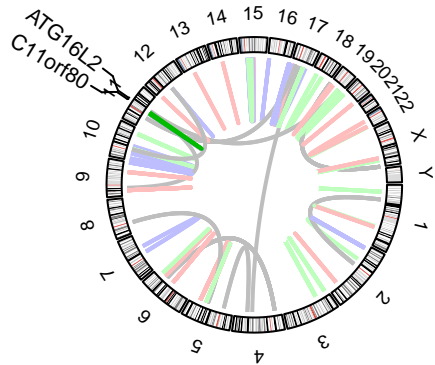
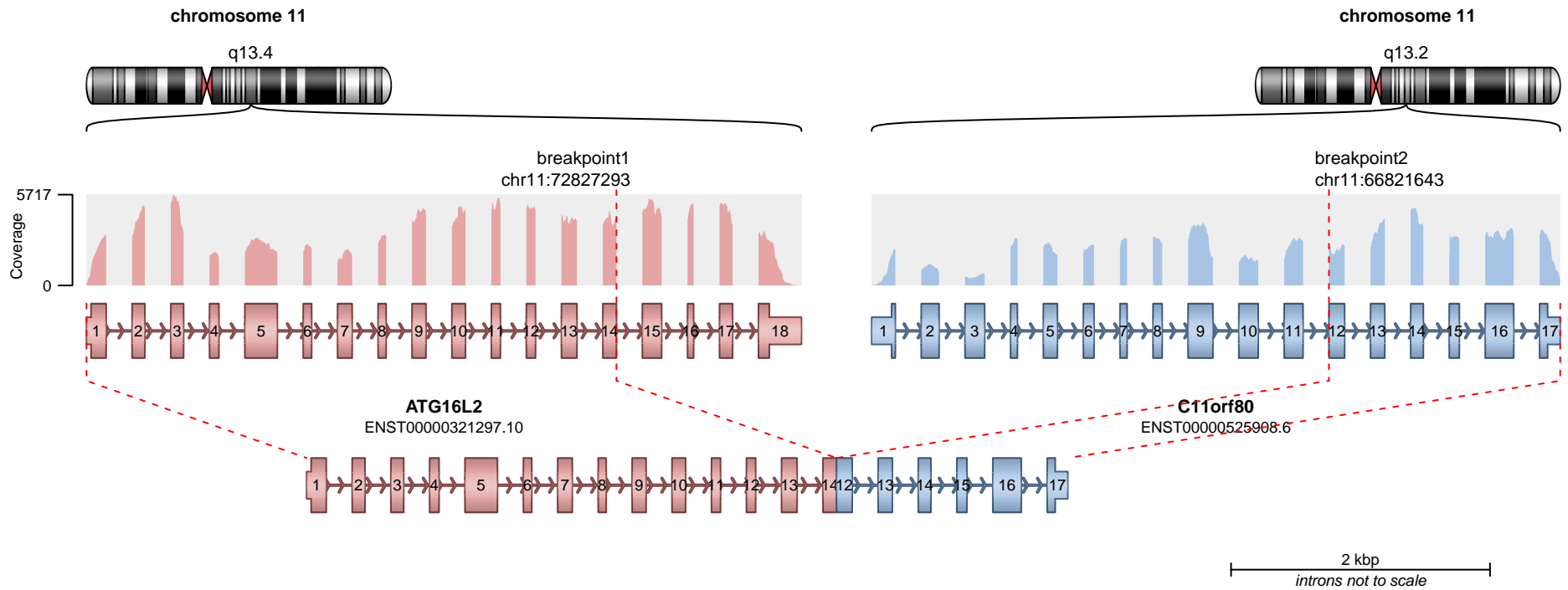

RETAINED PROTEIN DOMAINS
reading frame unclear

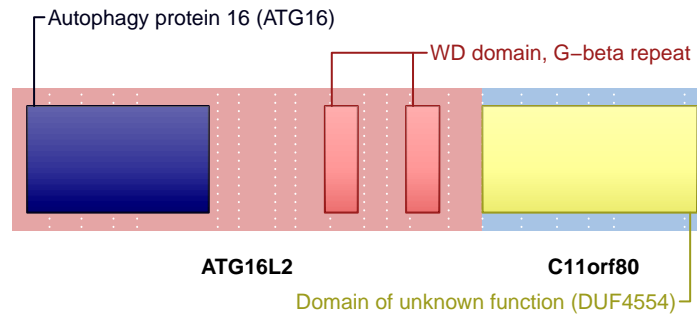

SUPPORTING READ COUNT

Split reads = 2
Discordant mates = 0

— translocation — deletion
— duplication — inversion

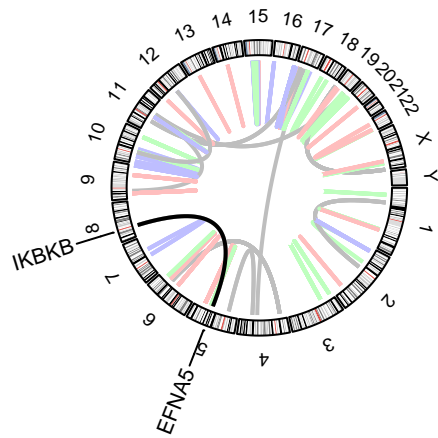
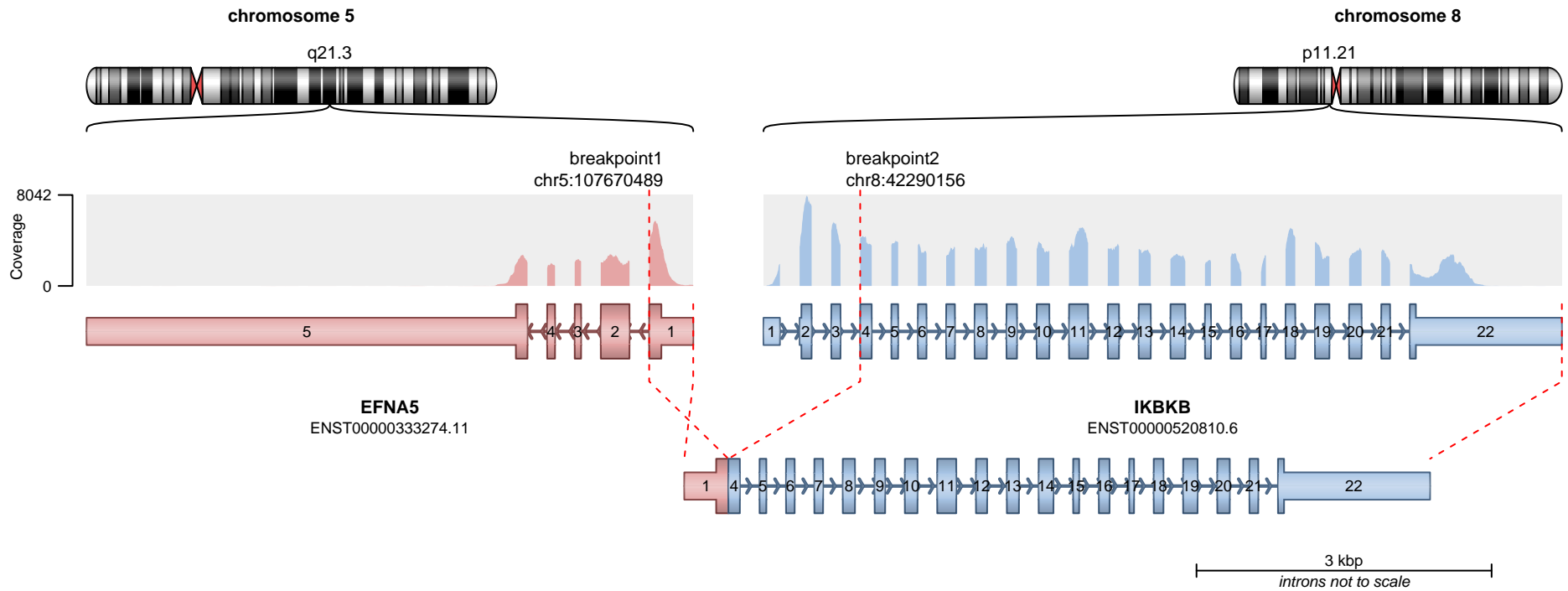

RETAINED PROTEIN DOMAINS
reading frame unclear

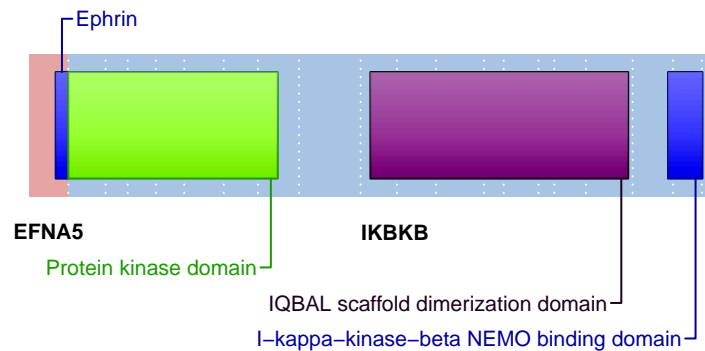

SUPPORTING READ COUNT

Split reads = 38
Discordant mates = 1

— translocation — deletion
— duplication — inversion

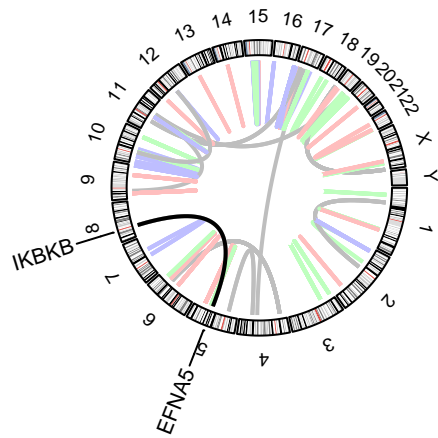
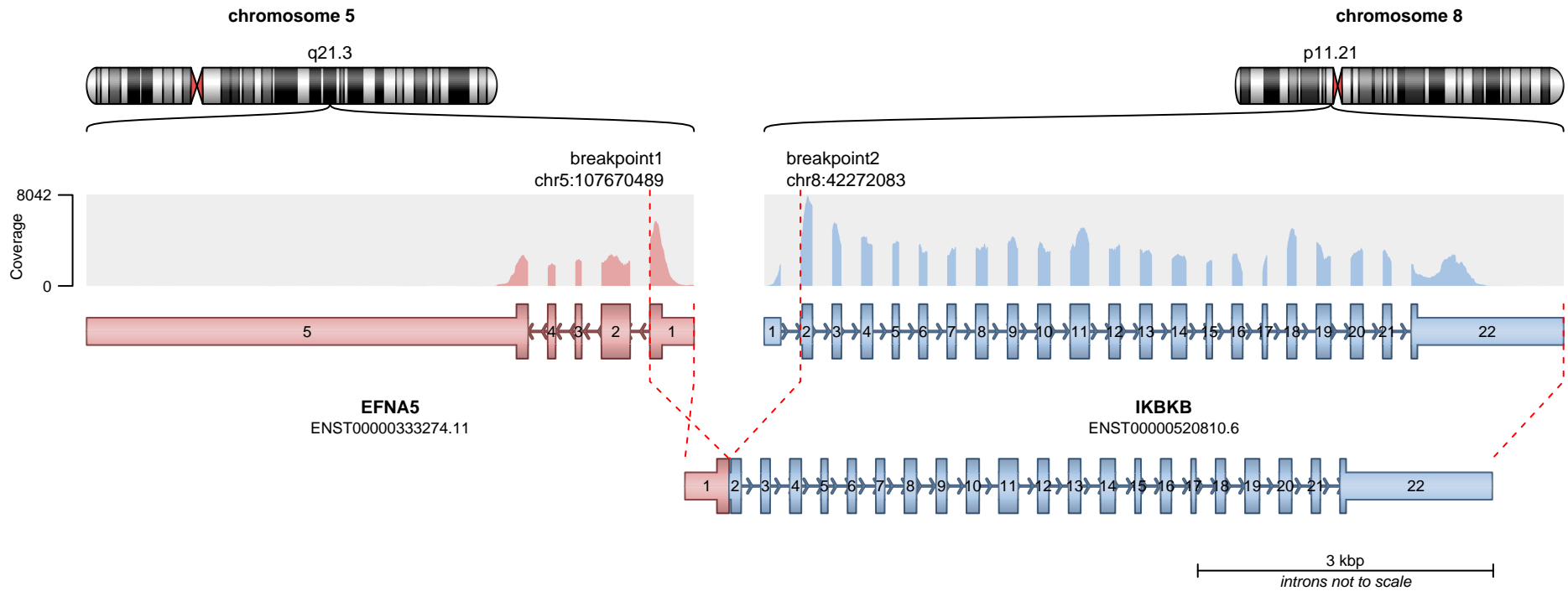

— translocation — deletion
— duplication — inversion

RETAINED PROTEIN DOMAINS
reading frame unclear

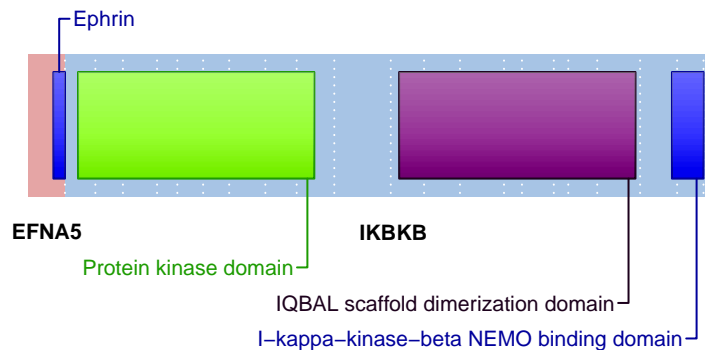

SUPPORTING READ COUNT

Split reads = 2
Discordant mates = 2

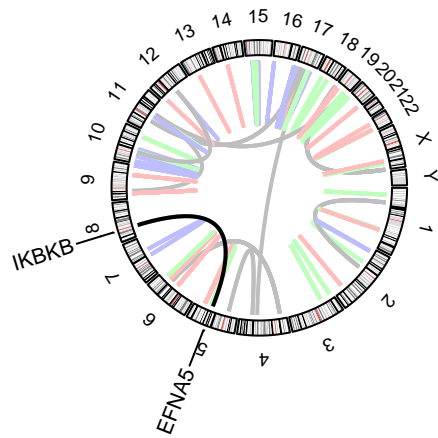
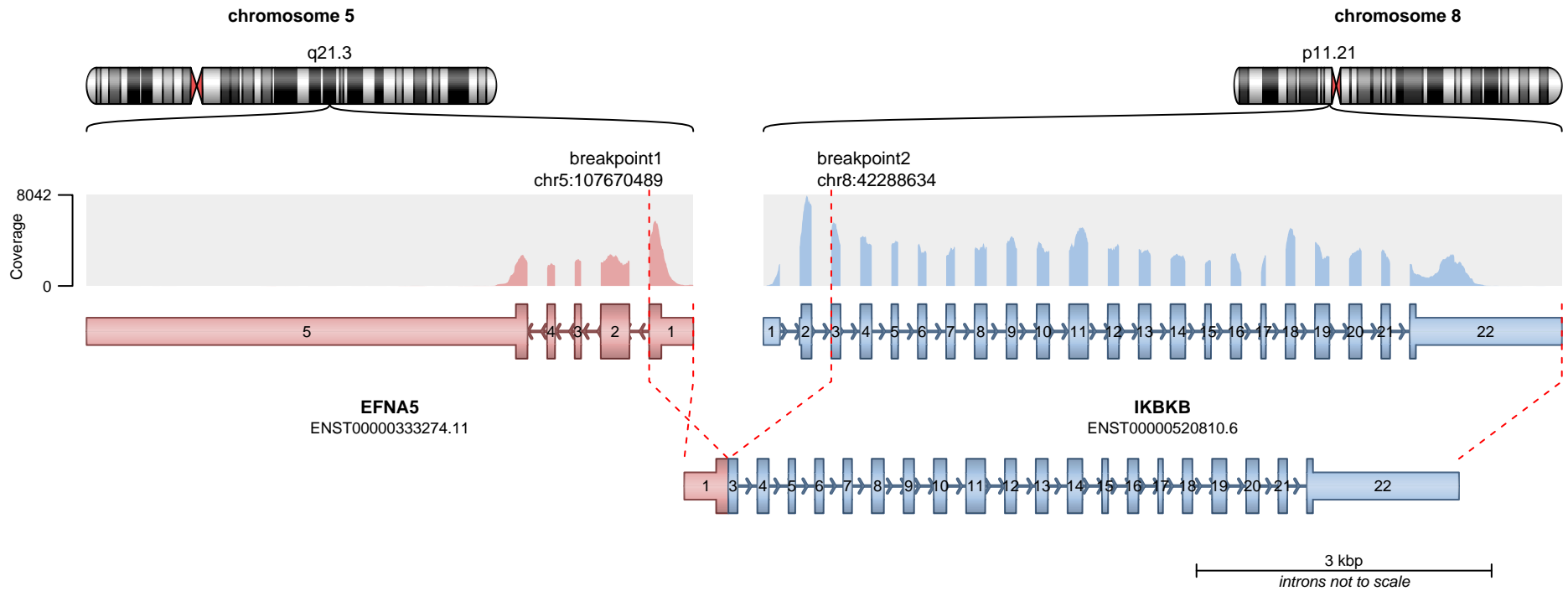

RETAINED PROTEIN DOMAINS
reading frame unclear

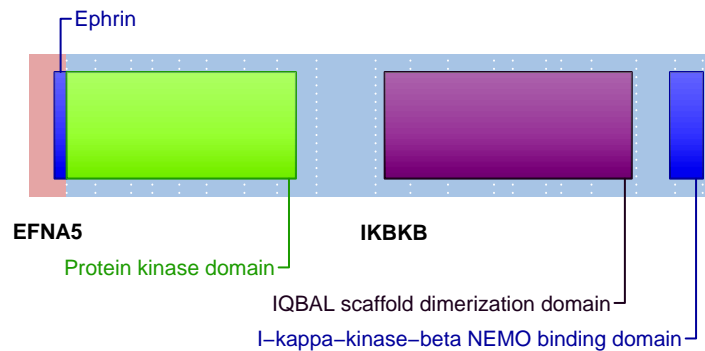

SUPPORTING READ COUNT

Split reads = 1
Discordant mates = 2

- translocation
- duplication
- deletion
- inversion

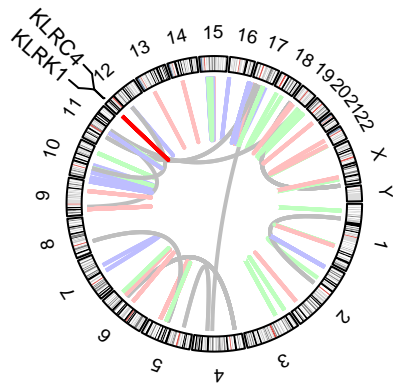
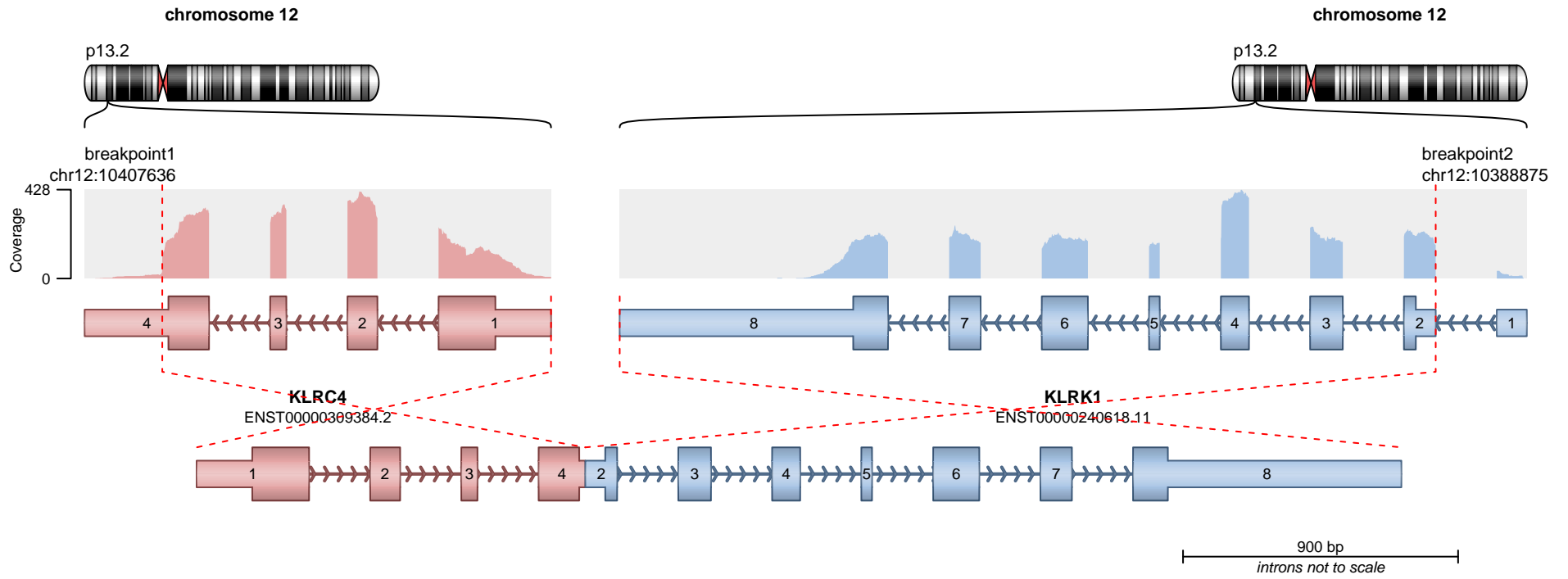

RETAINED PROTEIN DOMAINS
reading frame unclear

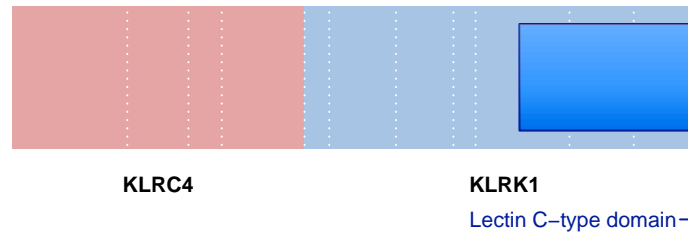

SUPPORTING READ COUNT

Split reads = 38
Discordant mates = 0

— translocation — deletion
— duplication — inversion

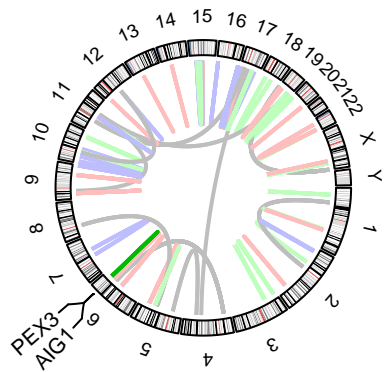
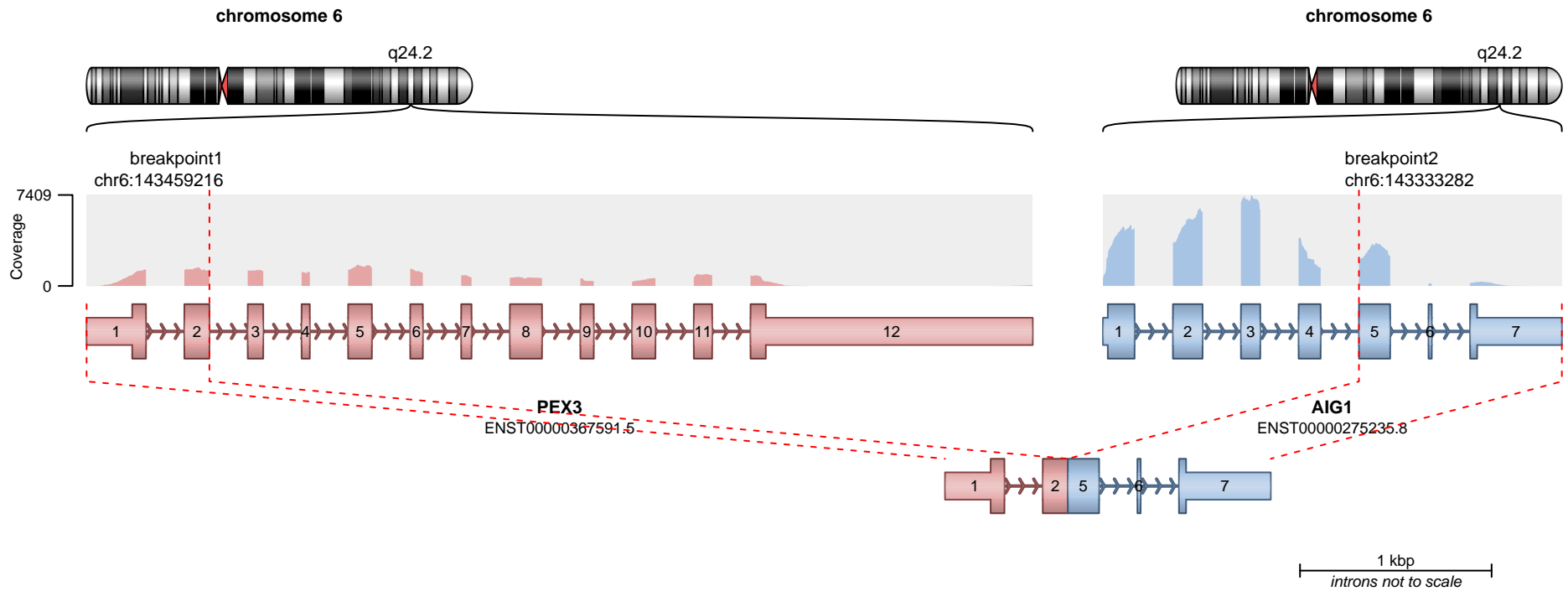

RETAINED PROTEIN DOMAINS
reading frame unclear

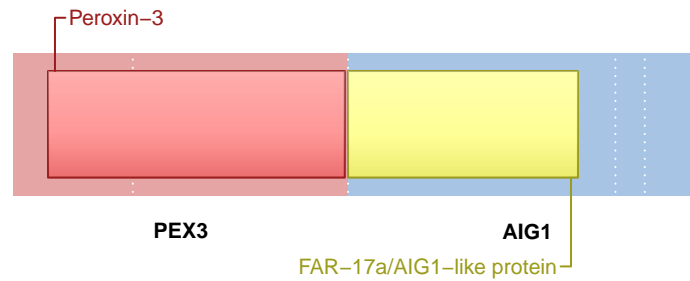

SUPPORTING READ COUNT

Split reads = 37
Discordant mates = 3

— translocation — deletion
— duplication — inversion

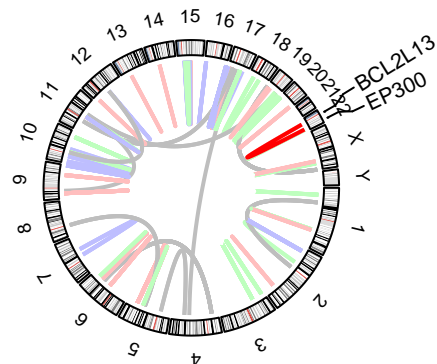
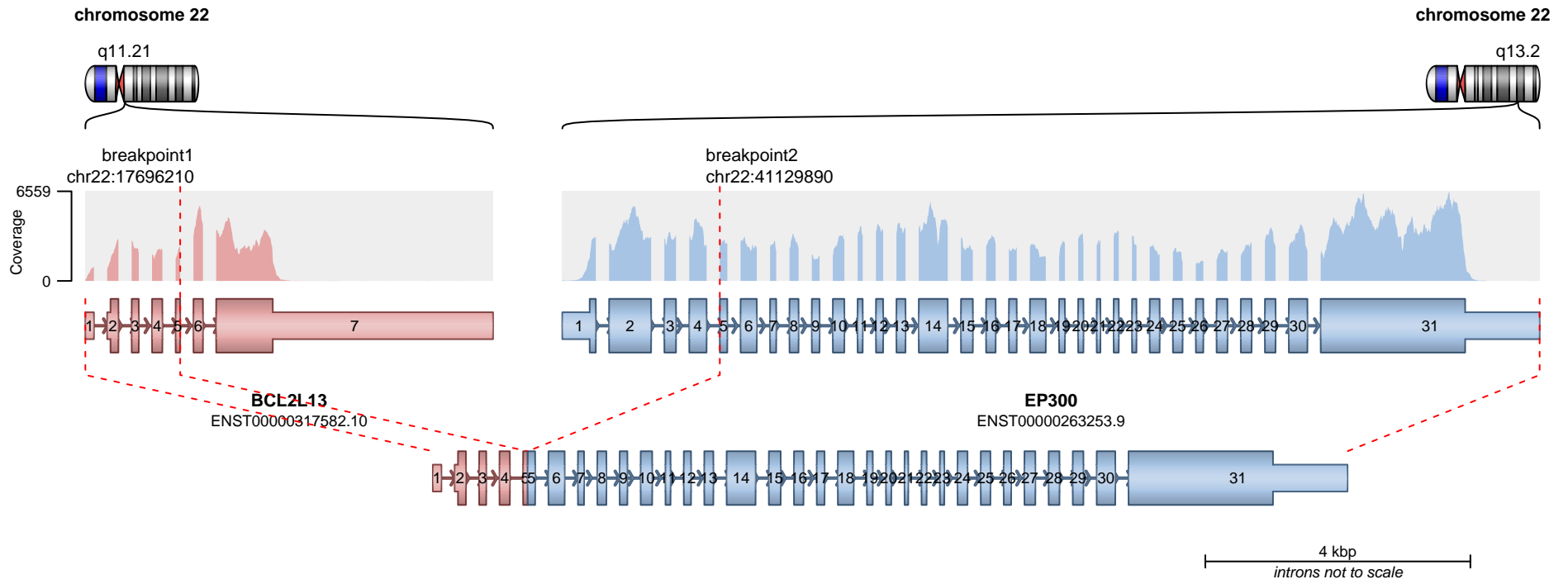

— translocation — deletion
— duplication — inversion

RETAINED PROTEIN DOMAINS
reading frame unclear

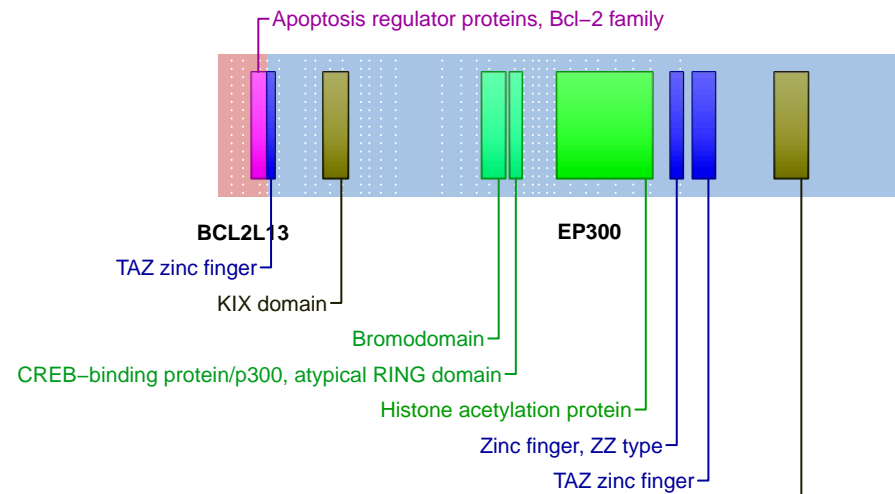

SUPPORTING READ COUNT

Split reads = 29
Discordant mates = 5

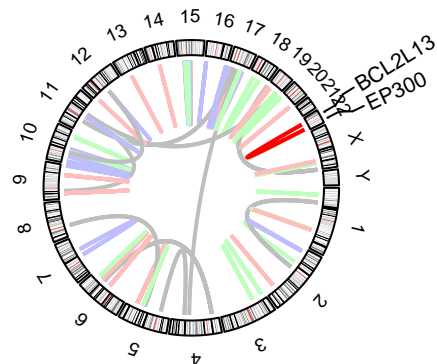
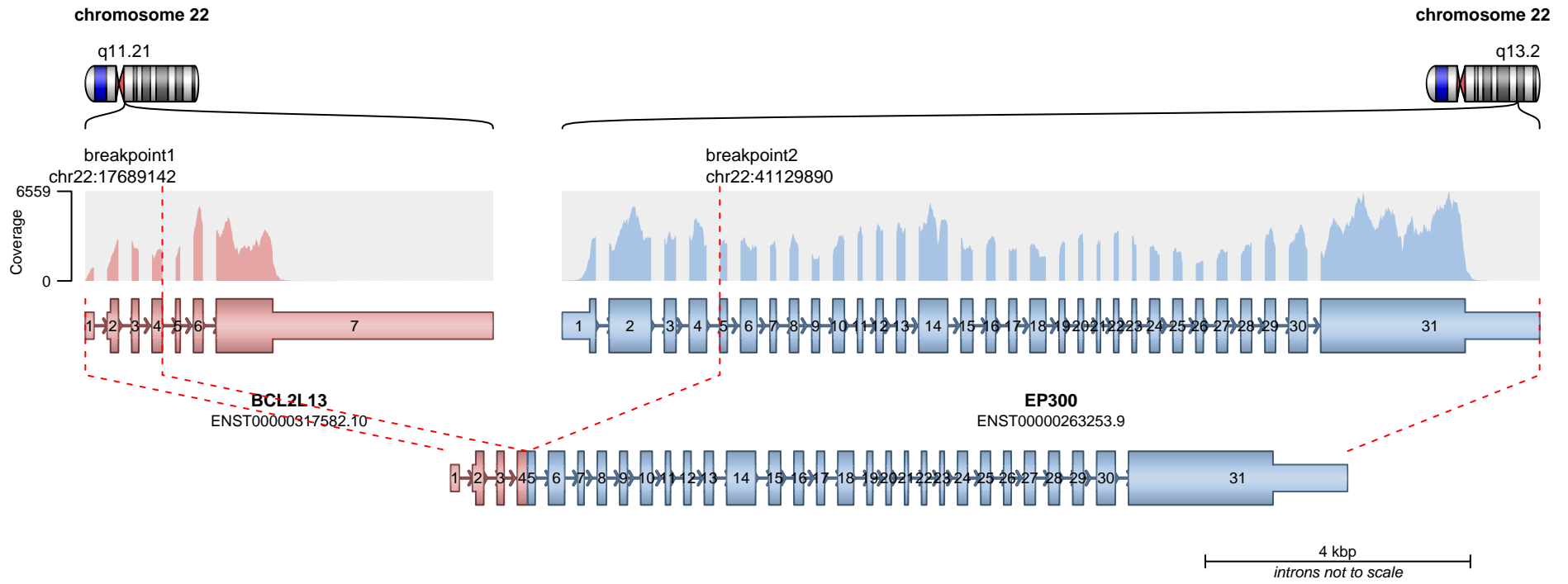

— translocation — deletion
— duplication — inversion

RETAINED PROTEIN DOMAINS
reading frame unclear

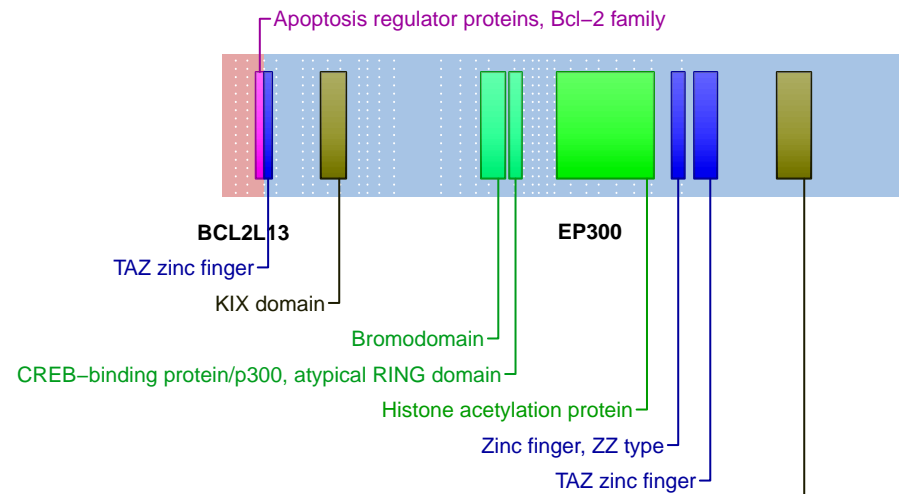

SUPPORTING READ COUNT

Split reads = 19
Discordant mates = 1

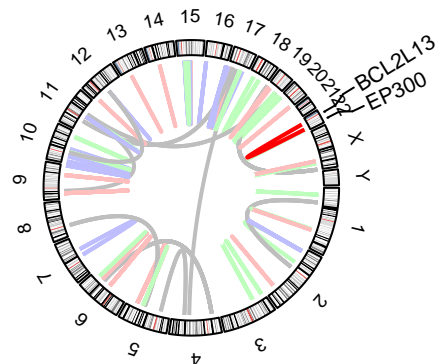
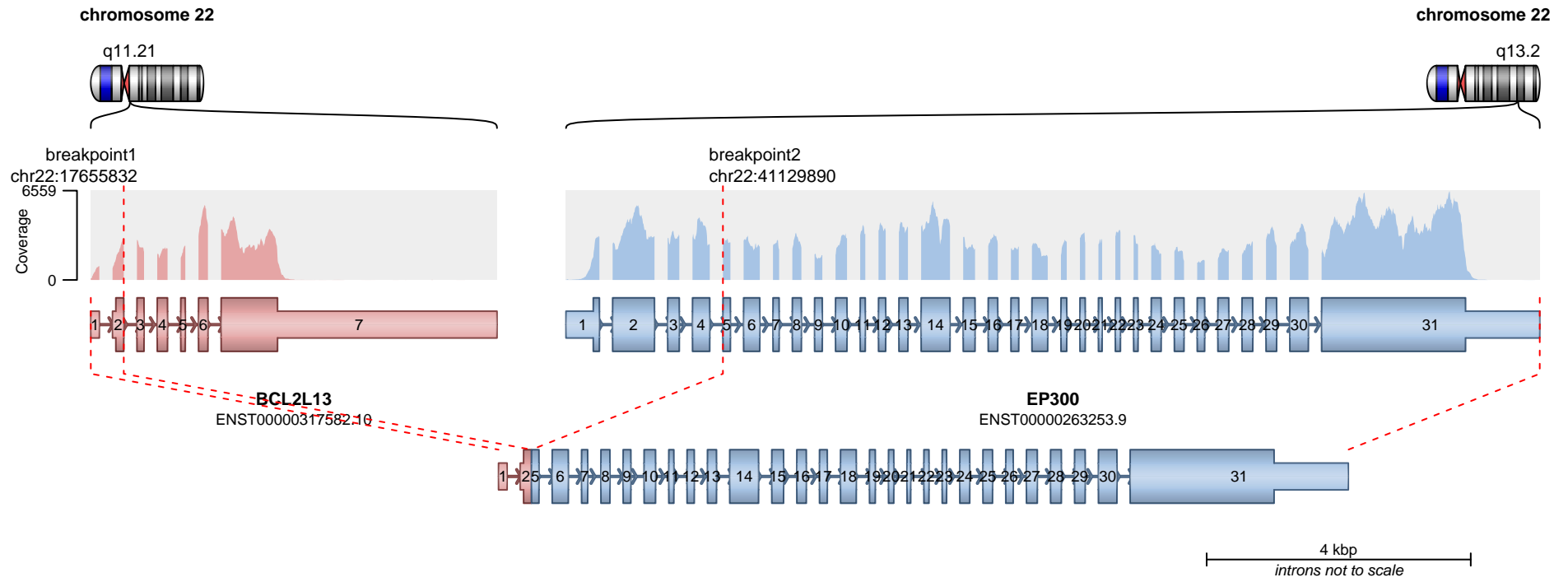

— translocation — deletion
— duplication — inversion

RETAINED PROTEIN DOMAINS
reading frame unclear

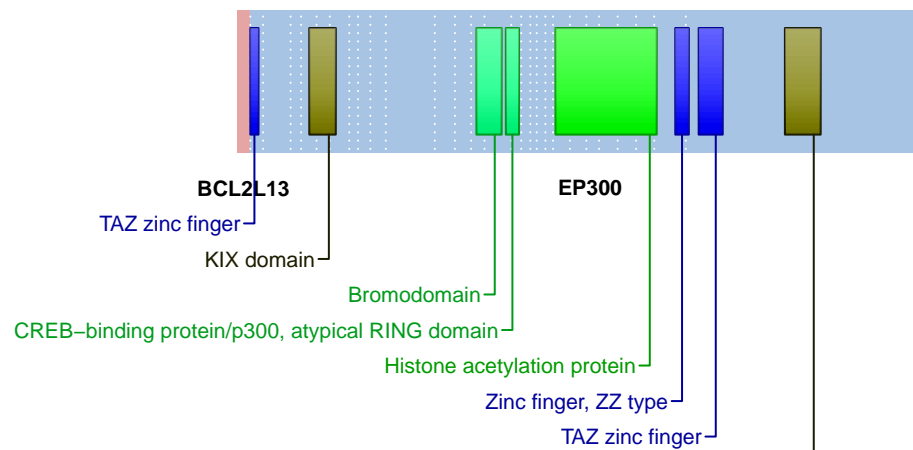

SUPPORTING READ COUNT

Split reads = 3
Discordant mates = 0

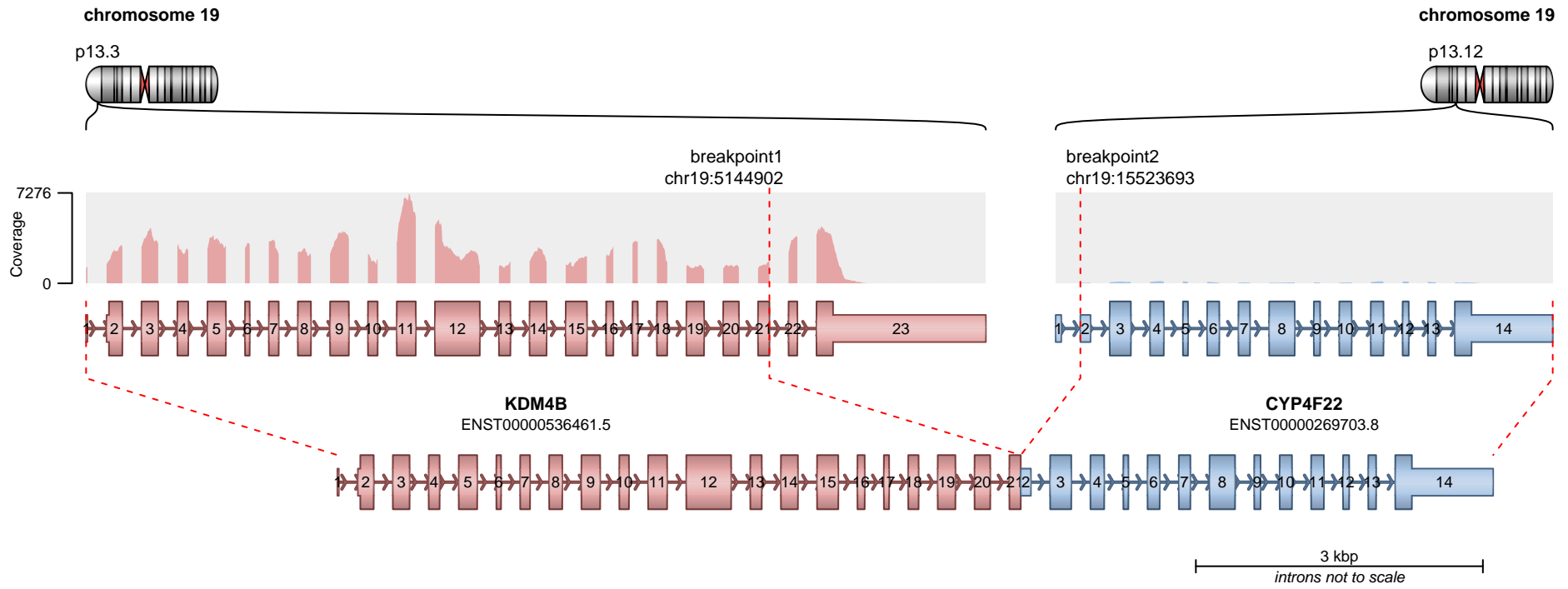

RETAINED PROTEIN DOMAINS
reading frame unclear

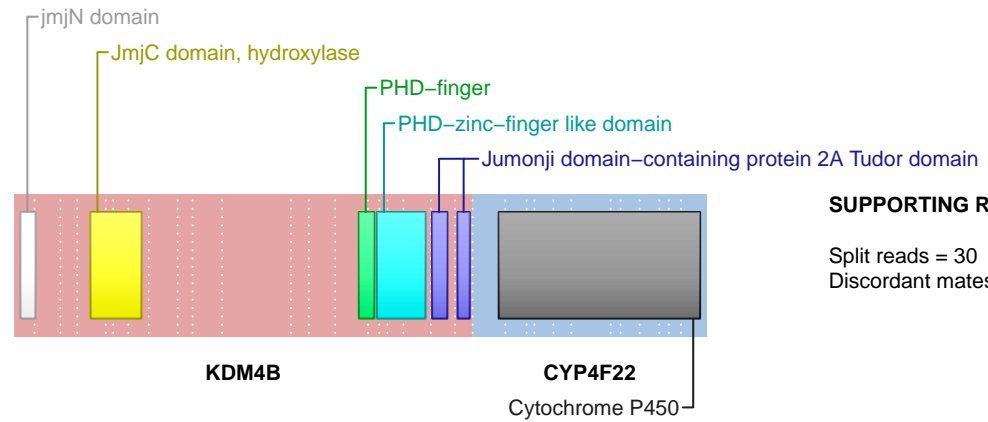
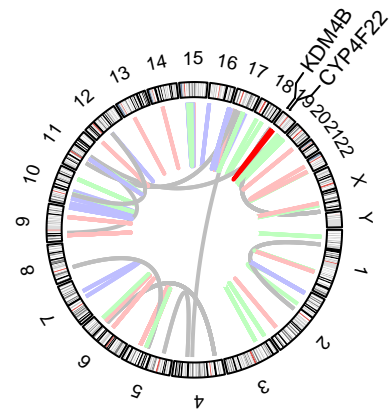

SUPPORTING READ COUNT

Split reads = 30
Discordant mates = 0

— translocation — deletion
— duplication — inversion

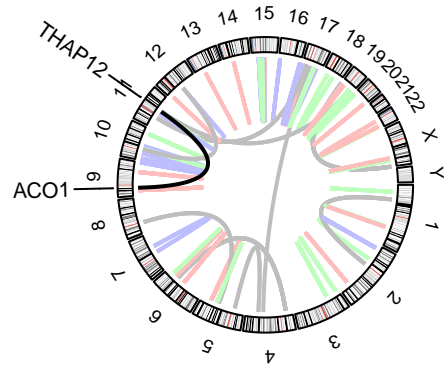
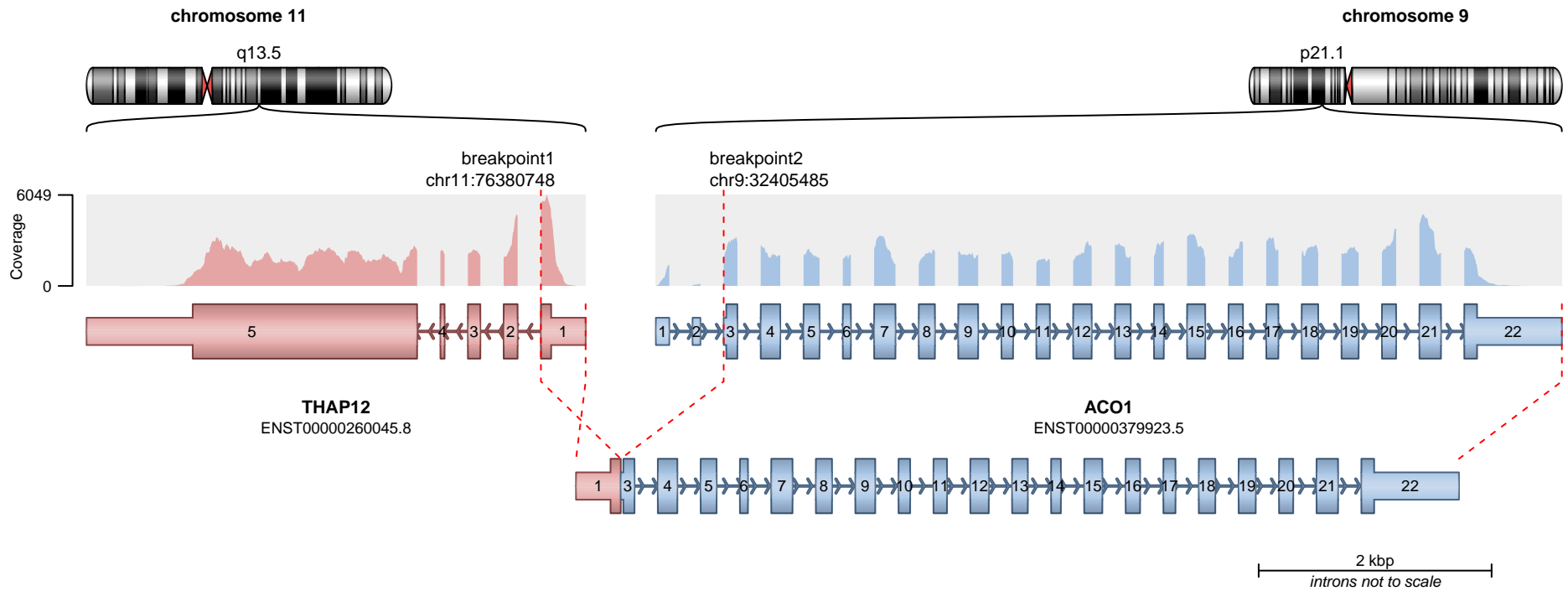

— translocation — deletion
— duplication — inversion

RETAINED PROTEIN DOMAINS
reading frame unclear

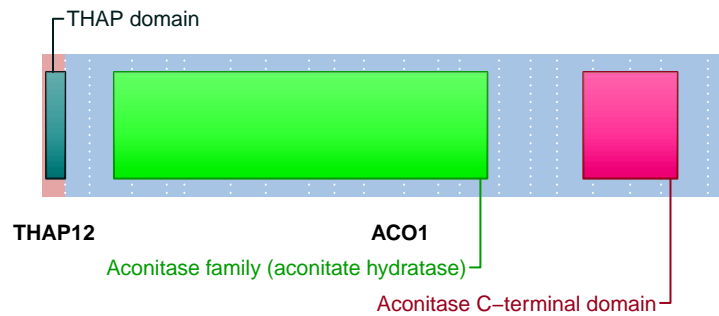

SUPPORTING READ COUNT

Split reads = 28
Discordant mates = 1

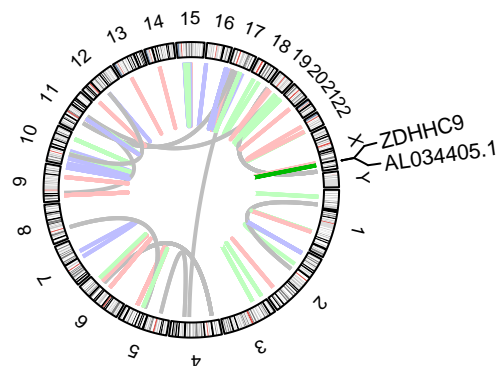
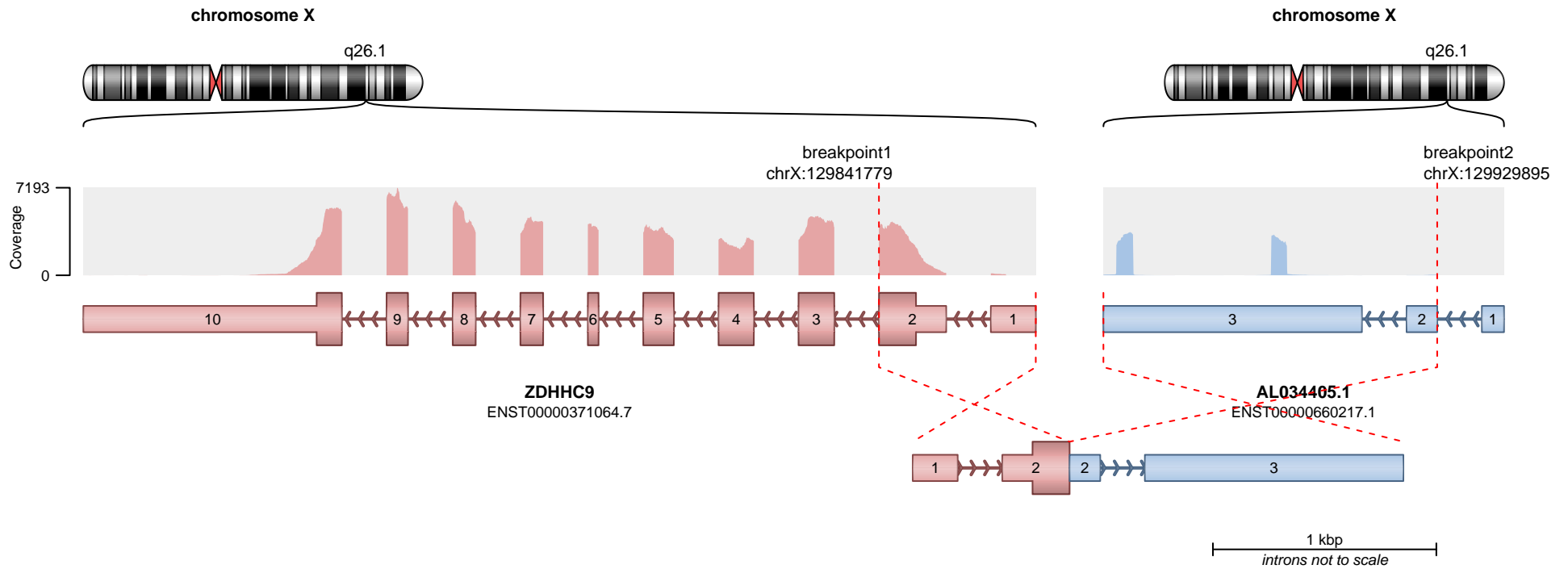

— translocation — deletion
 — duplication — inversion

No protein domains retained in fusion.

SUPPORTING READ COUNT

Split reads = 28
 Discordant mates = 1

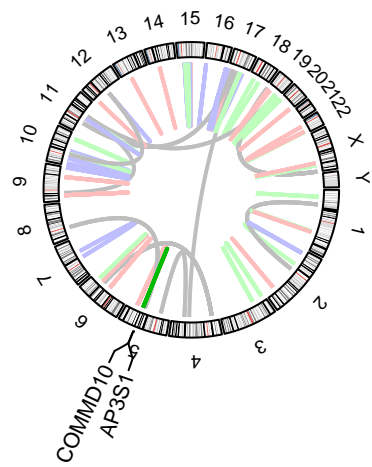
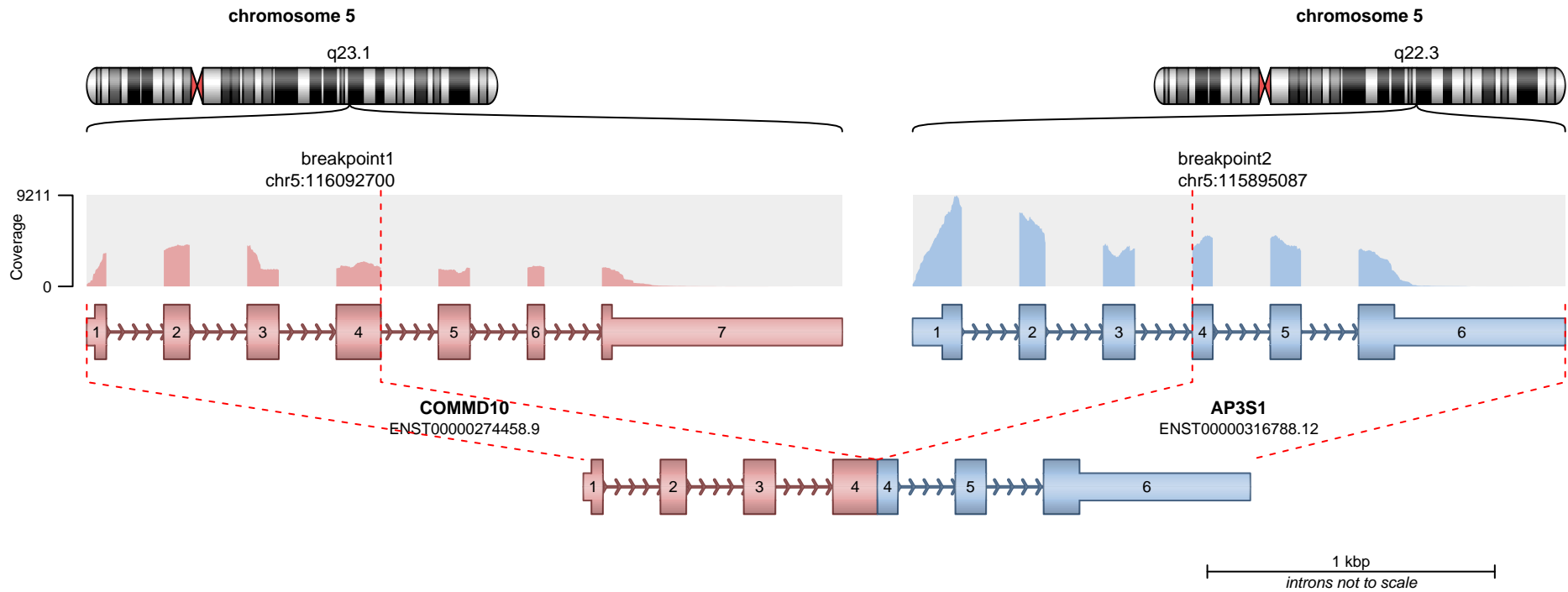

RETAINED PROTEIN DOMAINS
reading frame unclear

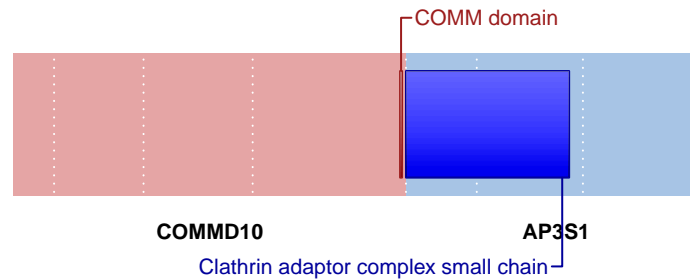

SUPPORTING READ COUNT

Split reads = 27
Discordant mates = 0

- translocation
- duplication
- deletion
- inversion

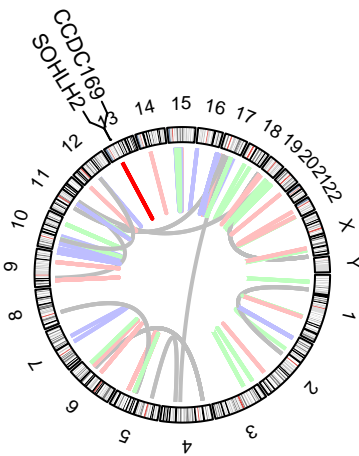
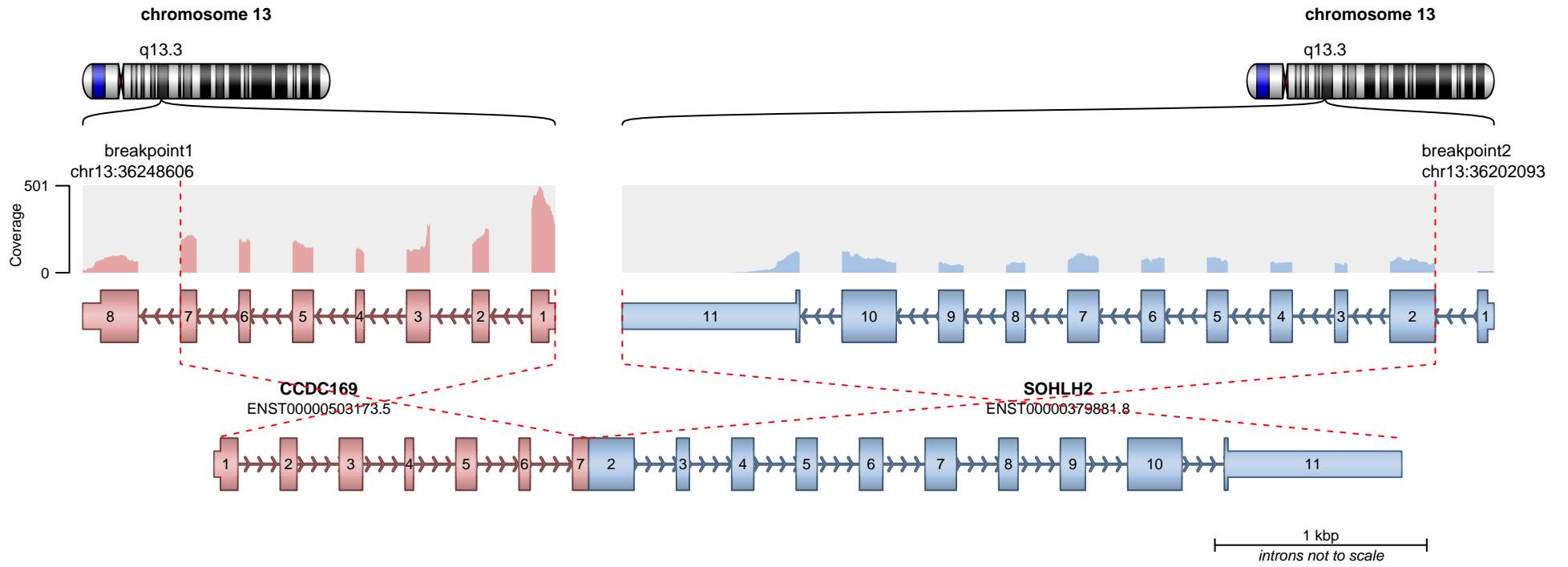

RETAINED PROTEIN DOMAINS
reading frame unclear

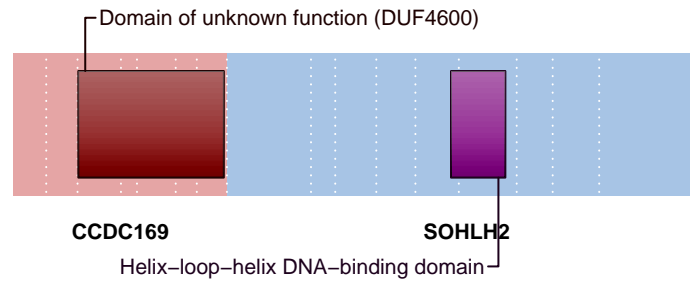

SUPPORTING READ COUNT

Split reads = 24
Discordant mates = 1

— translocation — deletion
— duplication — inversion

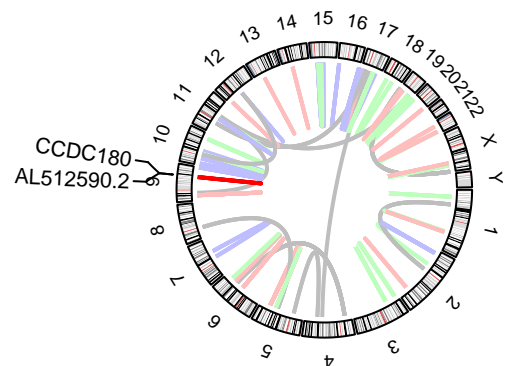
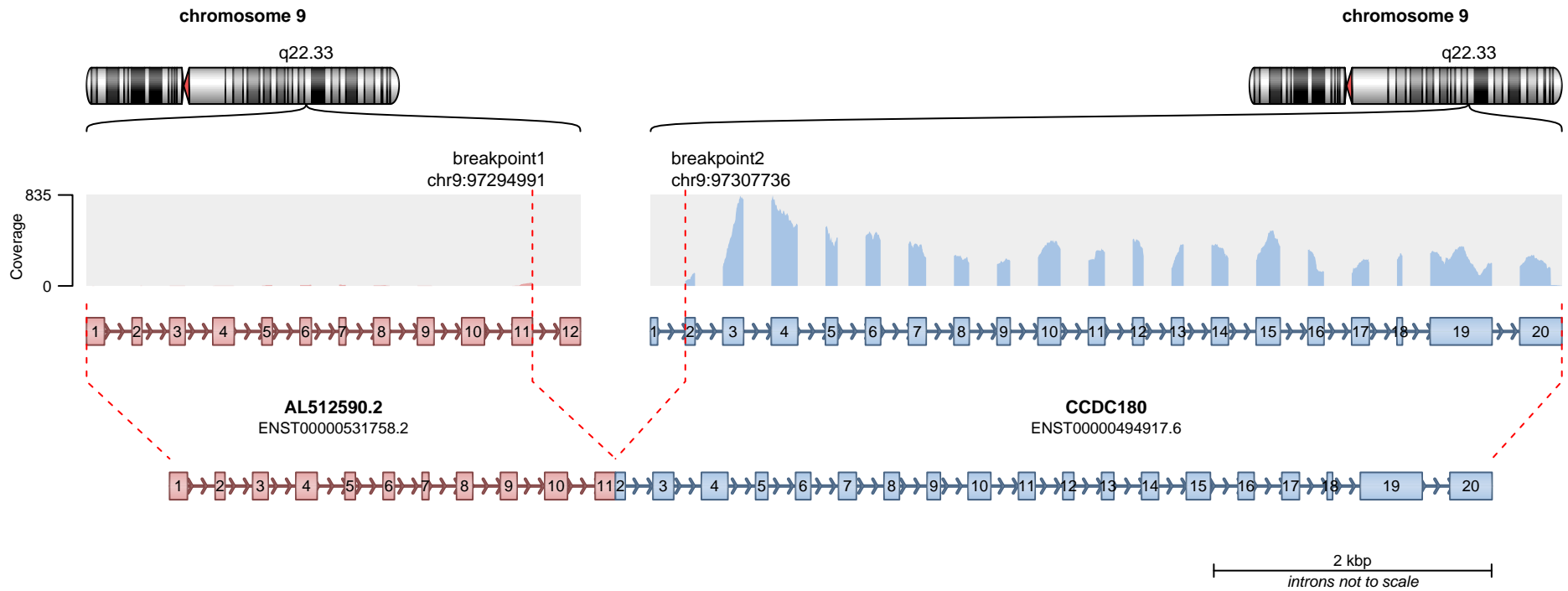

— translocation — deletion
— duplication — inversion

Genes are not protein-coding.

SUPPORTING READ COUNT

Split reads = 20
Discordant mates = 5

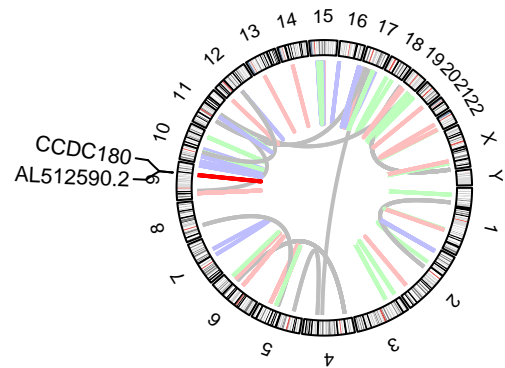
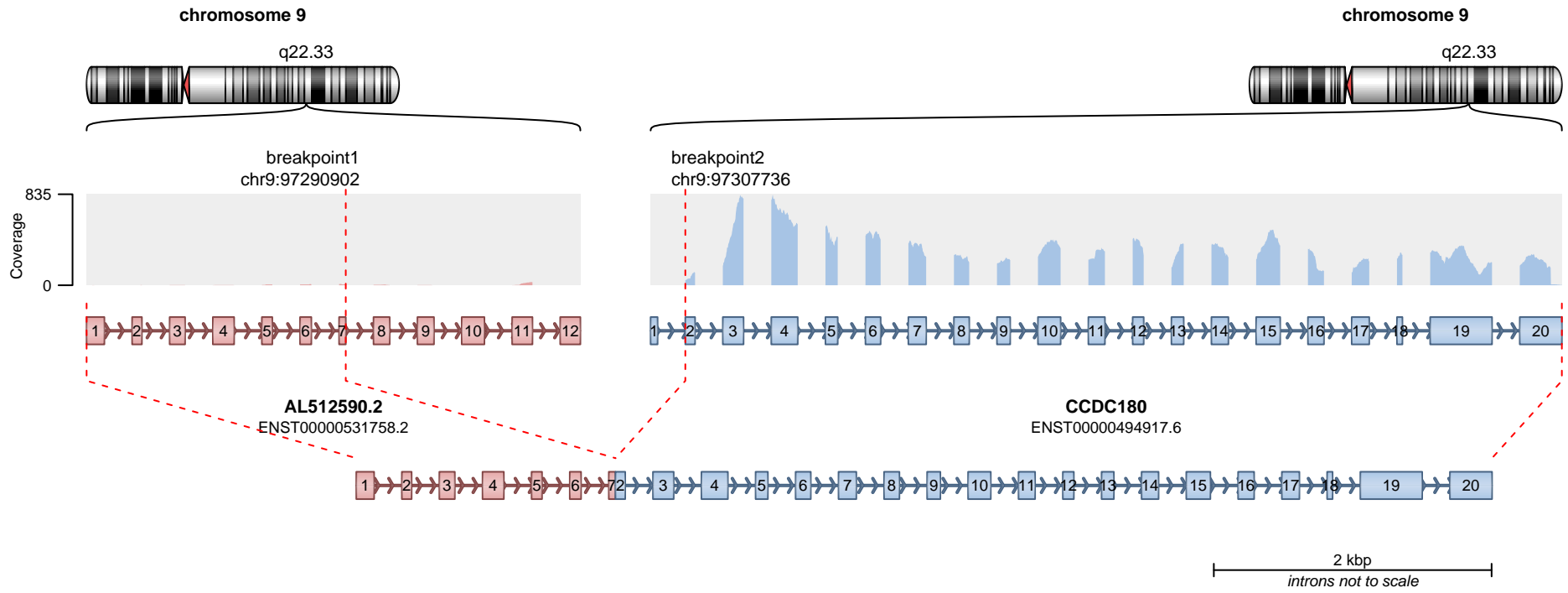

— translocation — deletion
— duplication — inversion

Genes are not protein-coding.

SUPPORTING READ COUNT

Split reads = 4
Discordant mates = 3

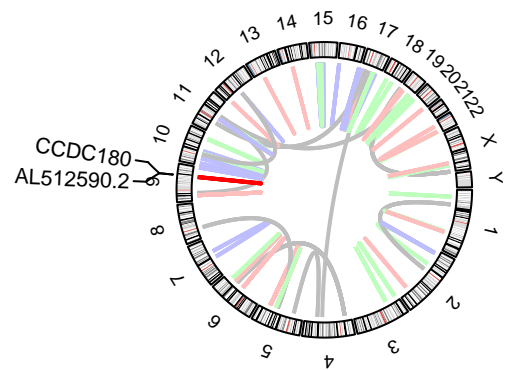
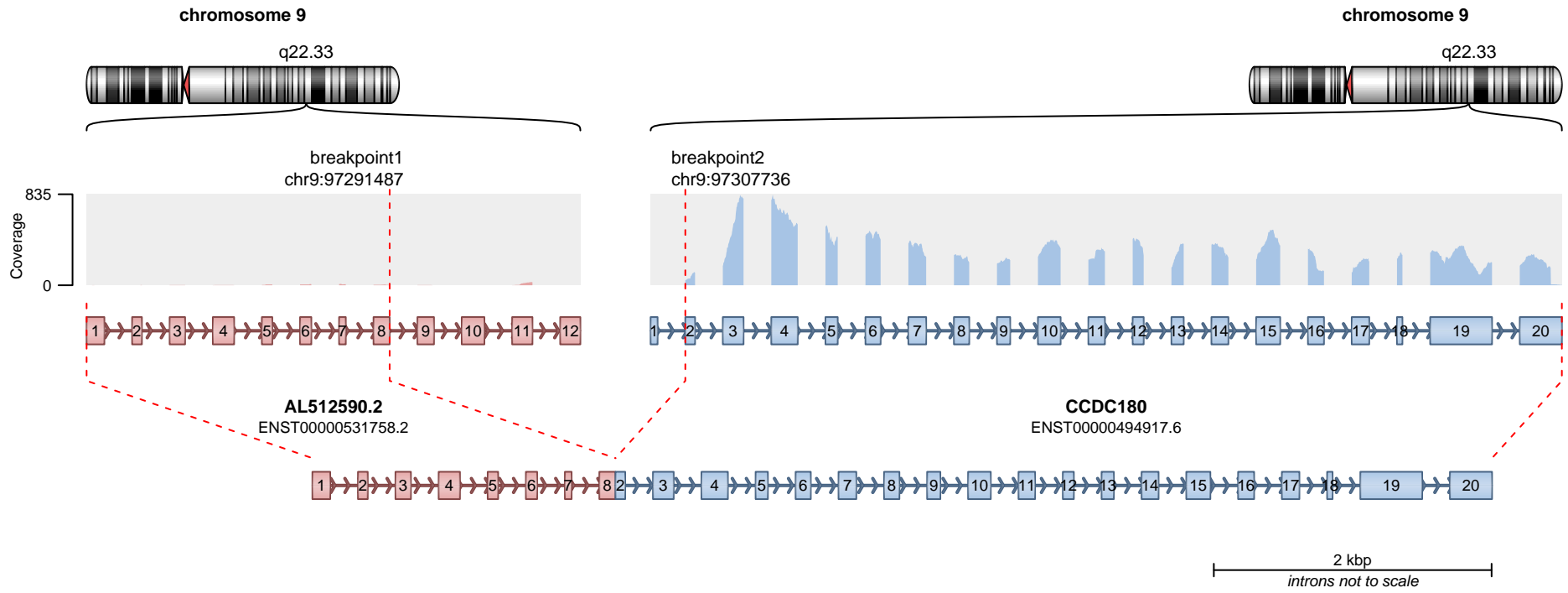

— translocation — deletion
— duplication — inversion

Genes are not protein-coding.

SUPPORTING READ COUNT

Split reads = 2
Discordant mates = 4

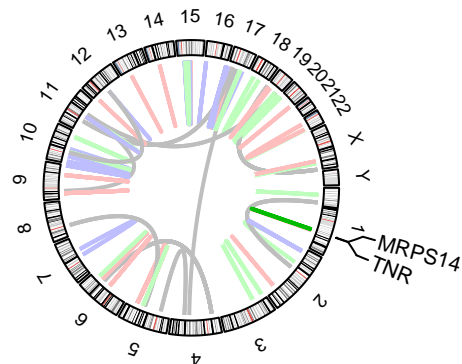
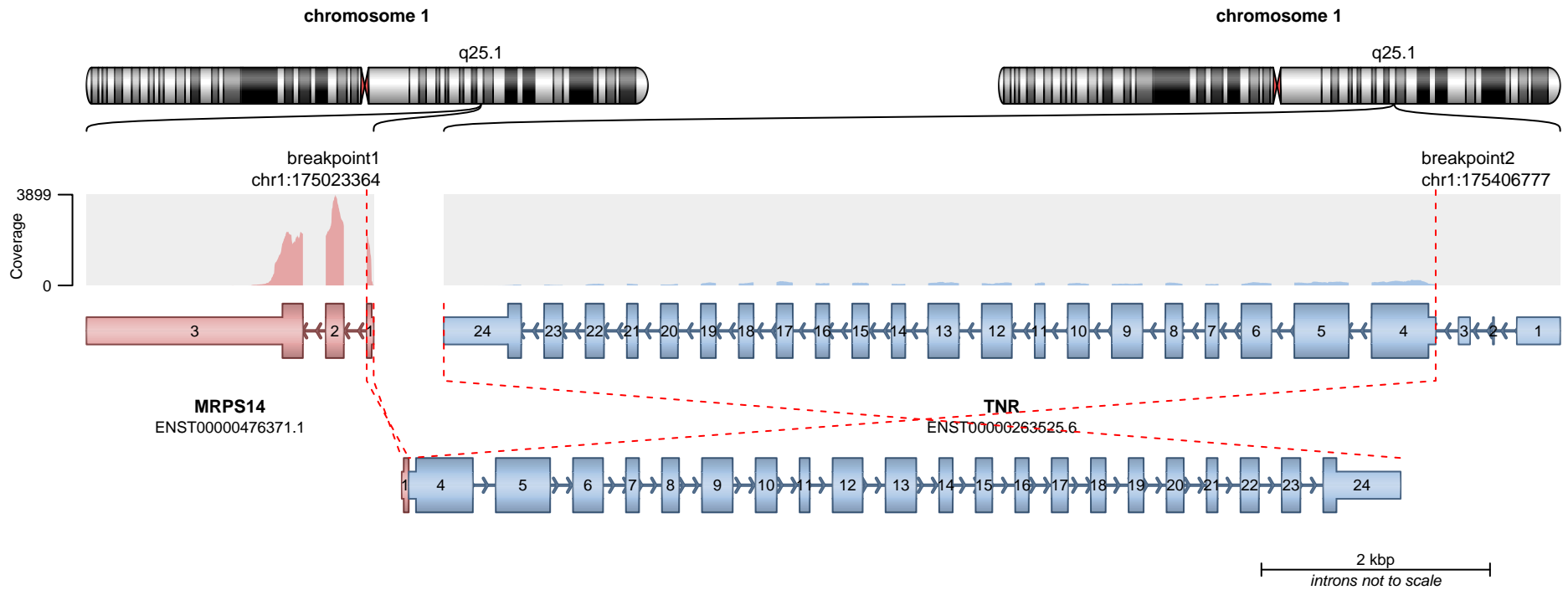

— translocation — deletion
— duplication — inversion

RETAINED PROTEIN DOMAINS
reading frame unclear

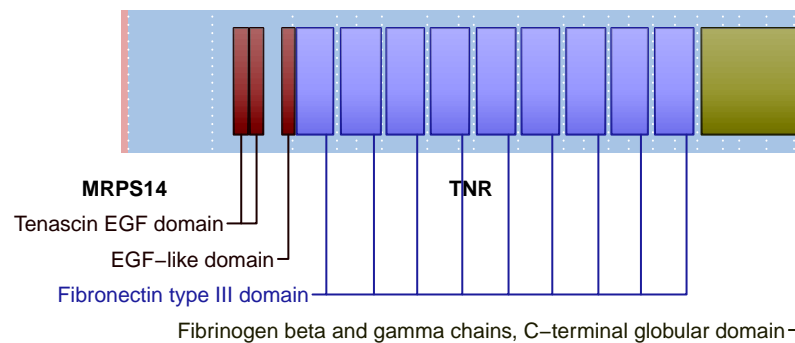

SUPPORTING READ COUNT

Split reads = 20
Discordant mates = 0

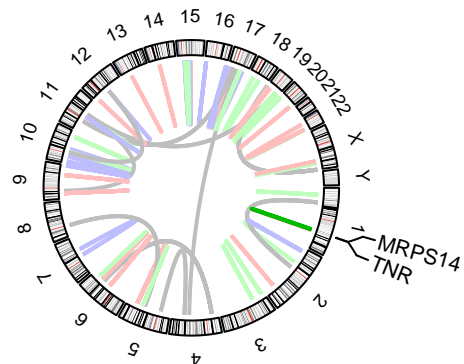
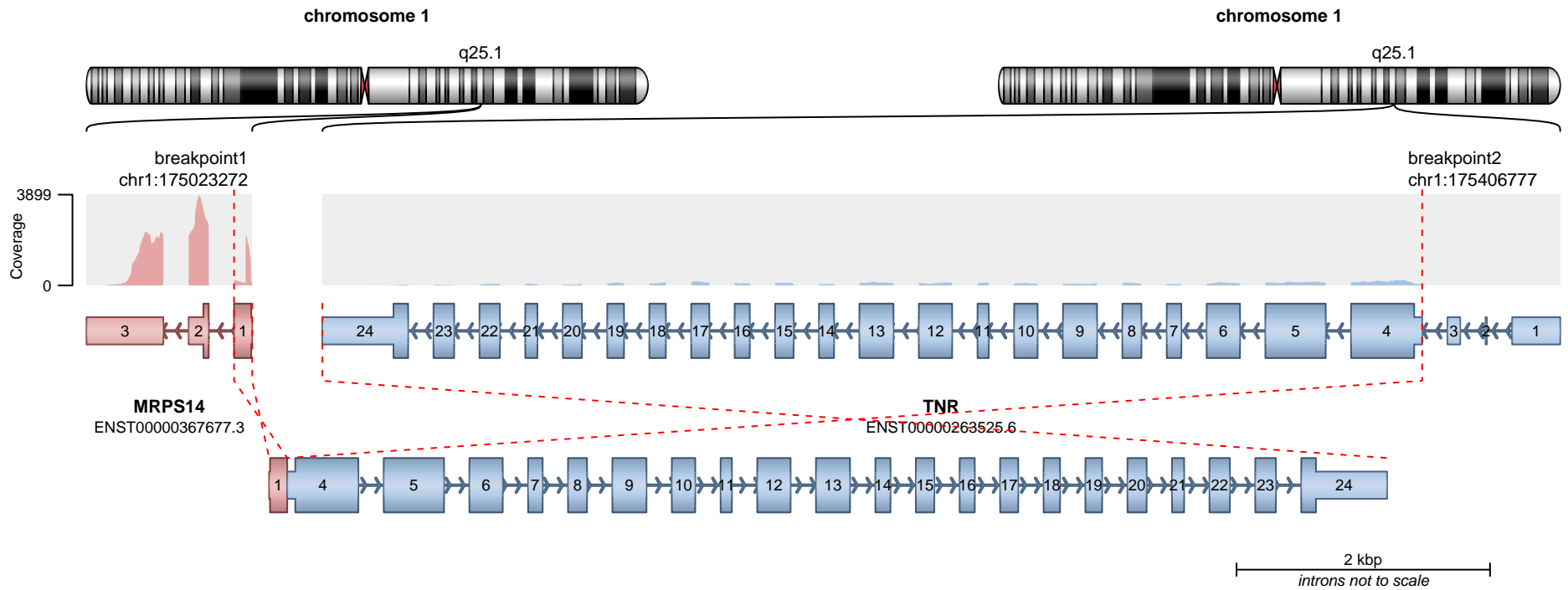

— translocation — deletion
— duplication — inversion

RETAINED PROTEIN DOMAINS
reading frame unclear

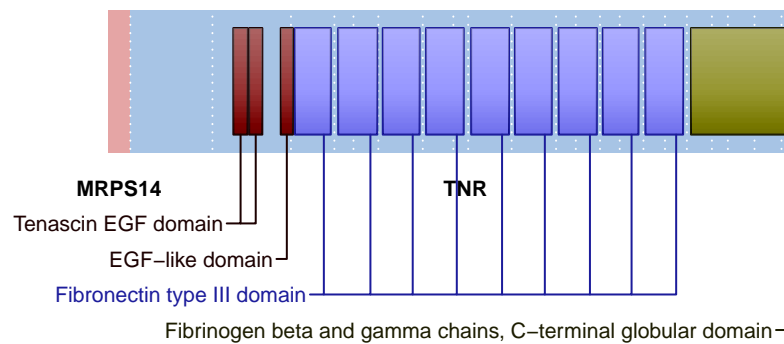

SUPPORTING READ COUNT

Split reads = 2
Discordant mates = 0

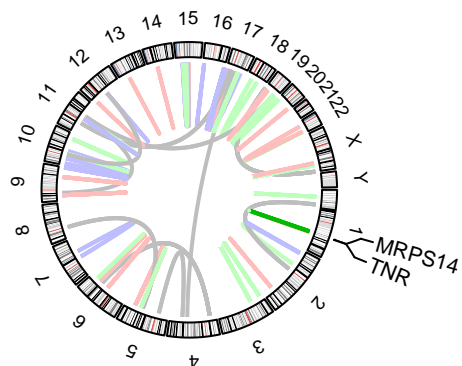
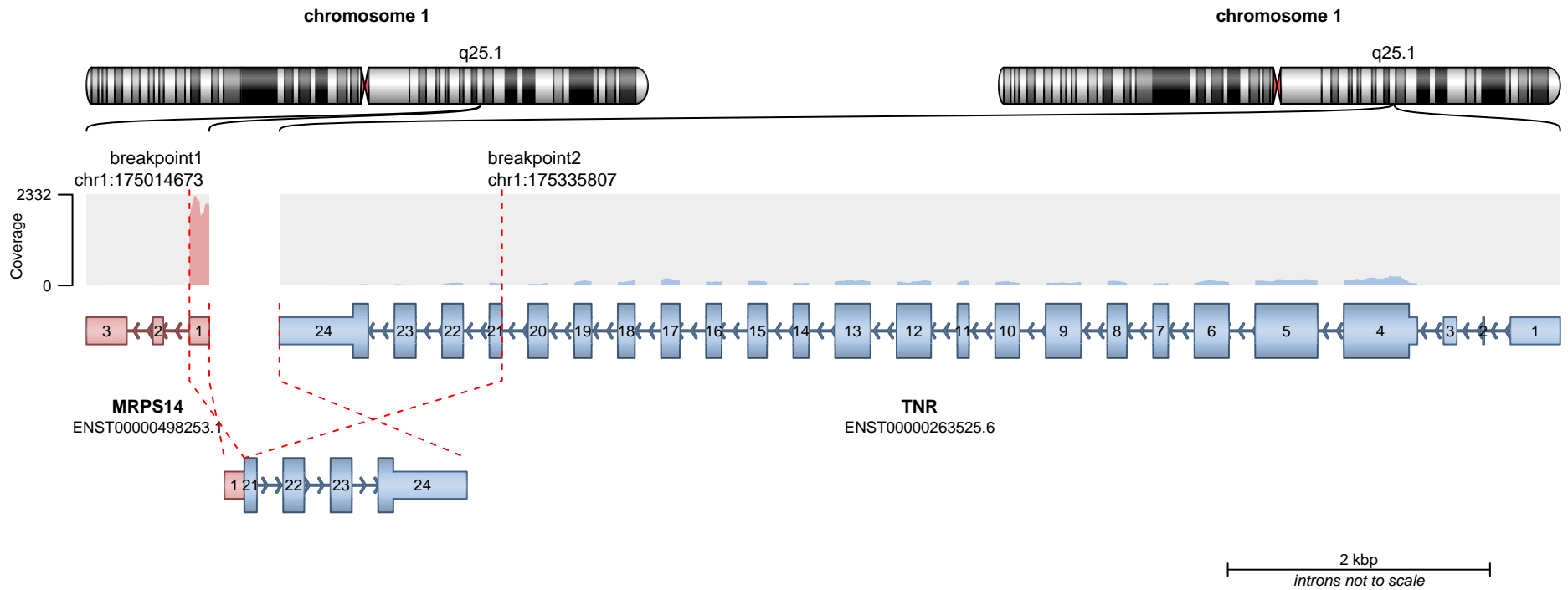

RETAINED PROTEIN DOMAINS
reading frame unclear

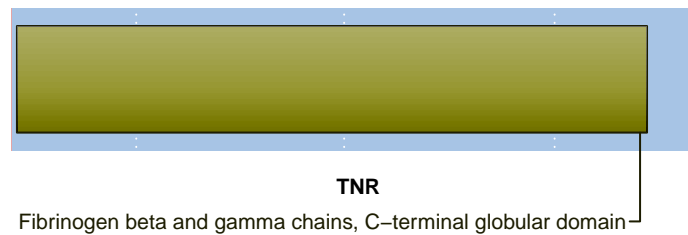

SUPPORTING READ COUNT

Split reads = 1
Discordant mates = 0

— translocation — deletion
— duplication — inversion

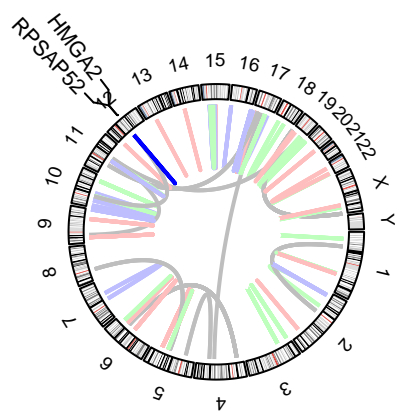
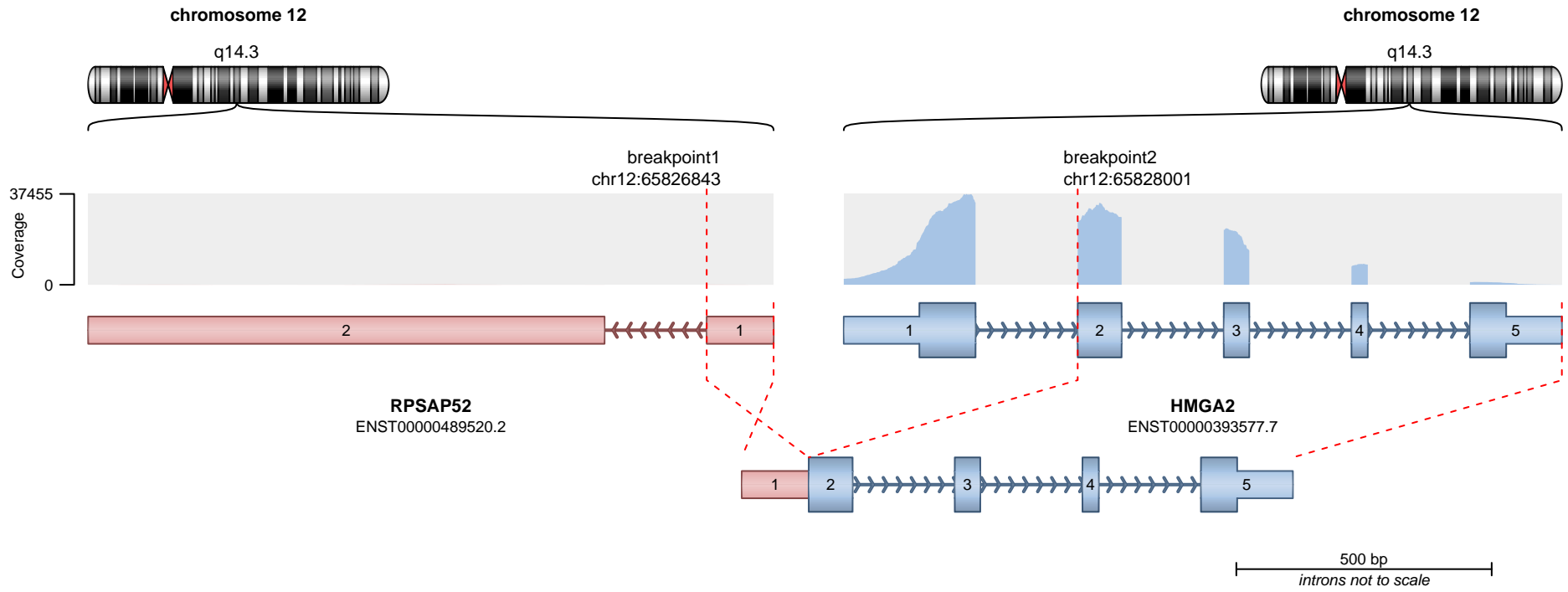

RETAINED PROTEIN DOMAINS
reading frame unclear

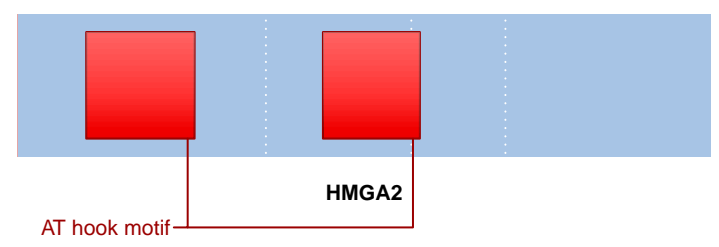

SUPPORTING READ COUNT

Split reads = 19
Discordant mates = 1

— translocation — deletion
— duplication — inversion

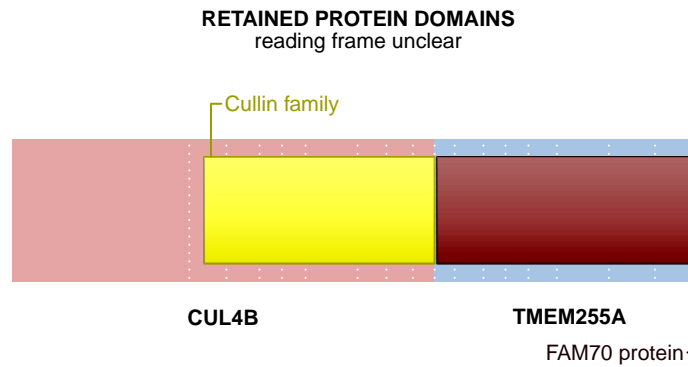
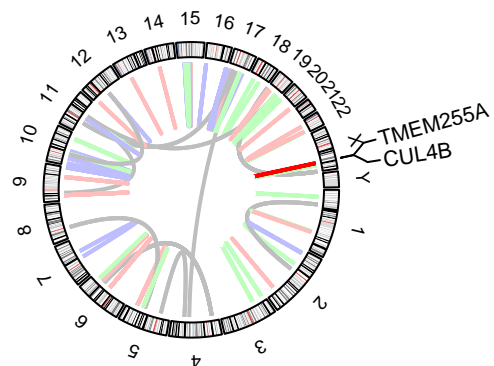
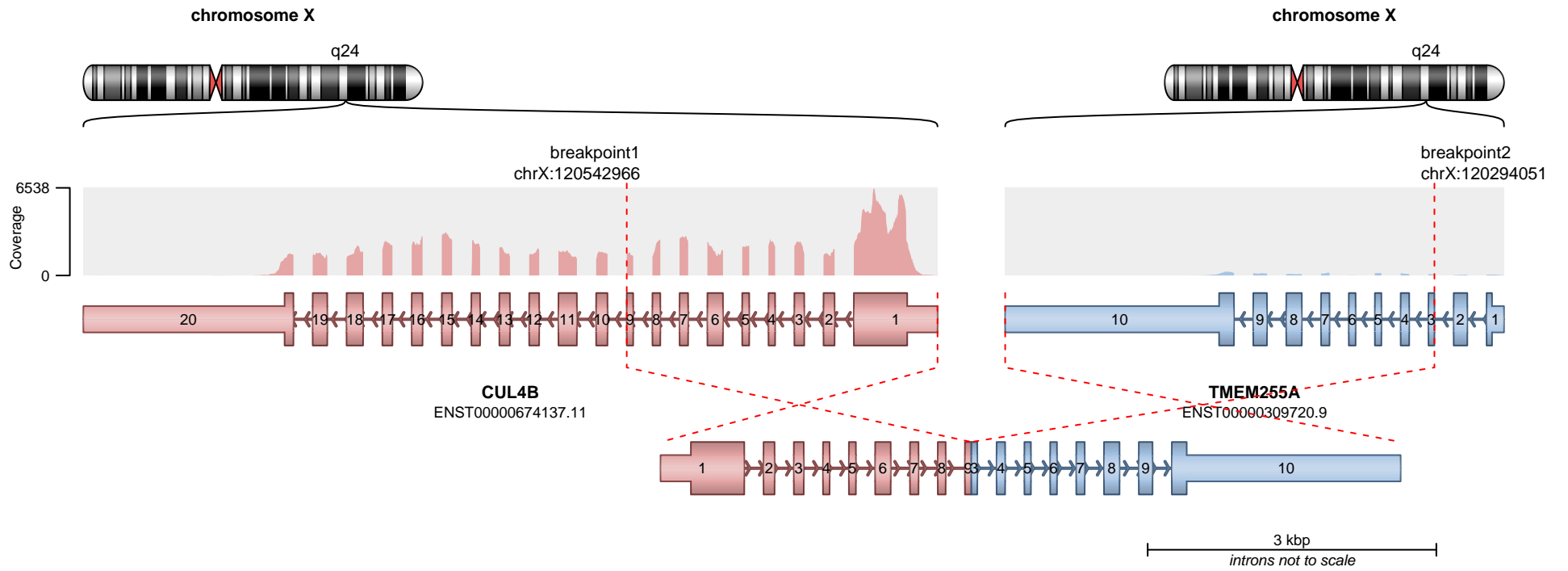

SUPPORTING READ COUNT

Split reads = 19
Discordant mates = 0

— translocation — deletion
— duplication — inversion

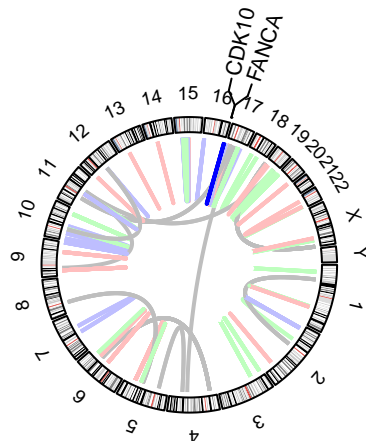
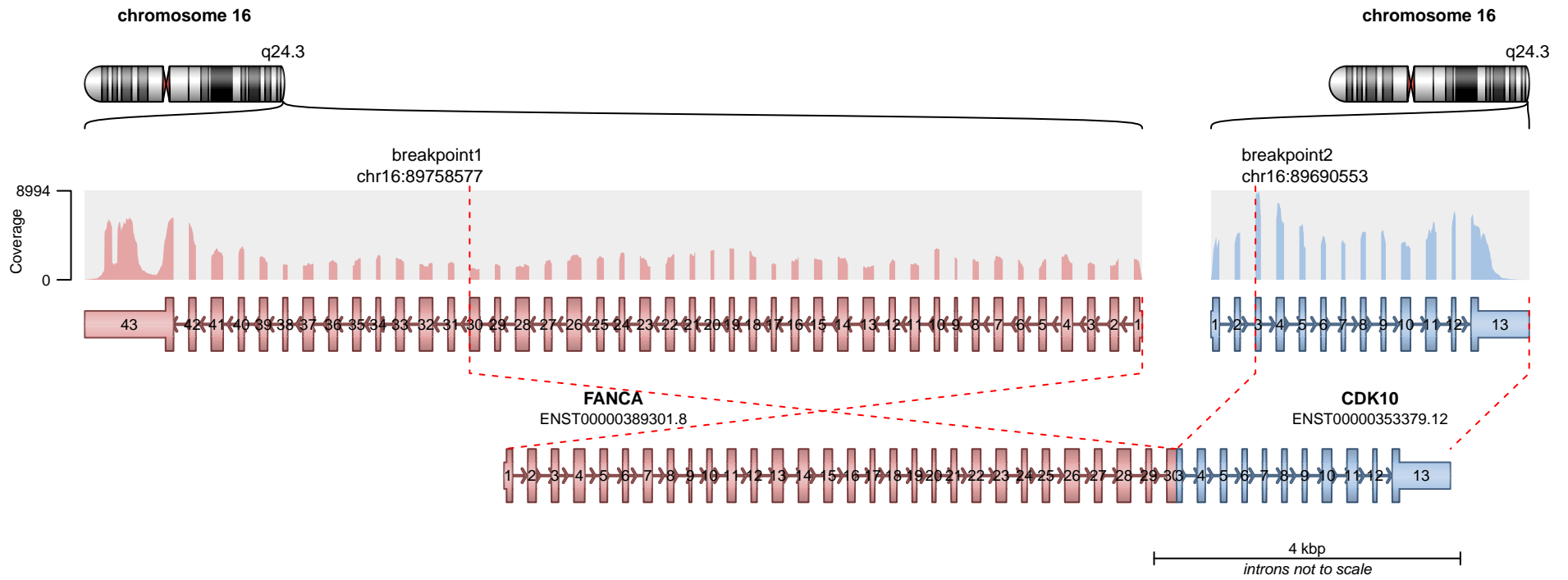

RETAINED PROTEIN DOMAINS
reading frame unclear

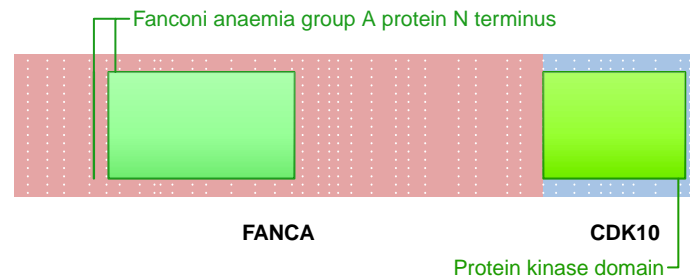

SUPPORTING READ COUNT

Split reads = 18
Discordant mates = 1

- translocation
- duplication
- deletion
- inversion

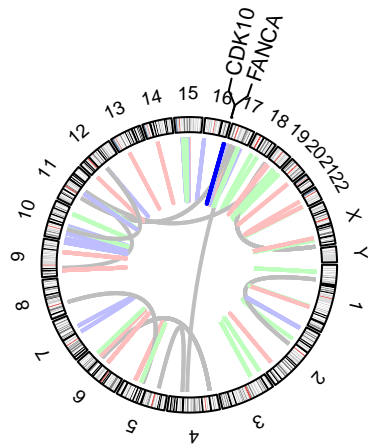
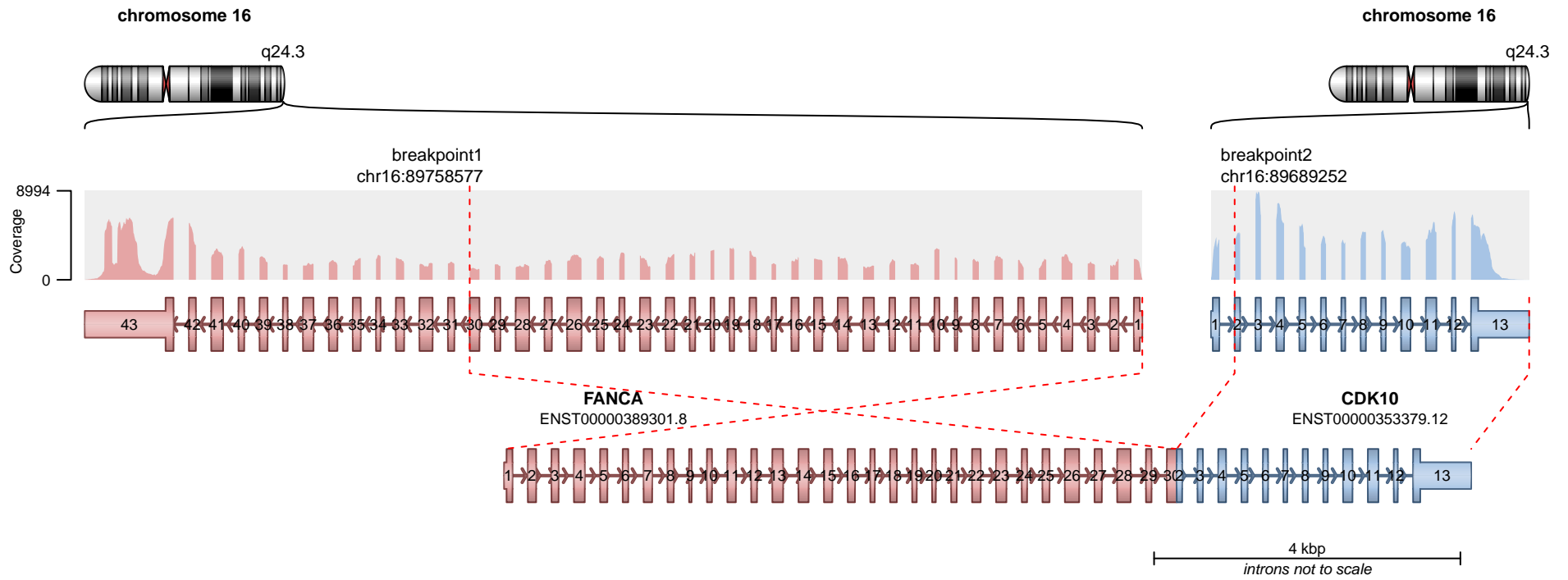

RETAINED PROTEIN DOMAINS
reading frame unclear

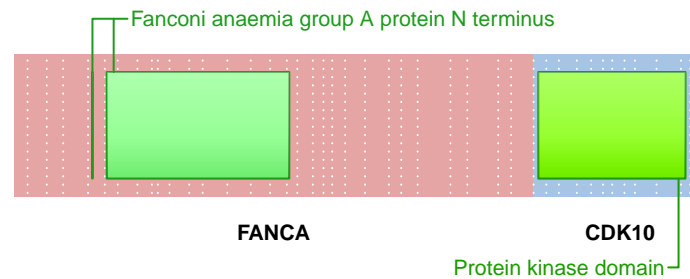

SUPPORTING READ COUNT

Split reads = 13
Discordant mates = 2

- translocation
- duplication
- deletion
- inversion

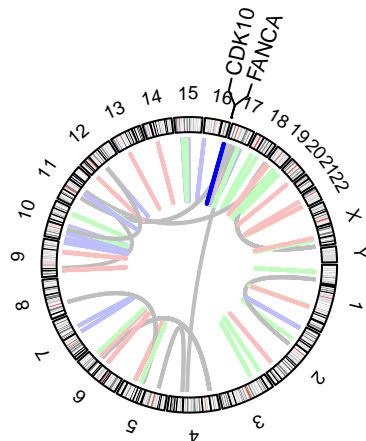
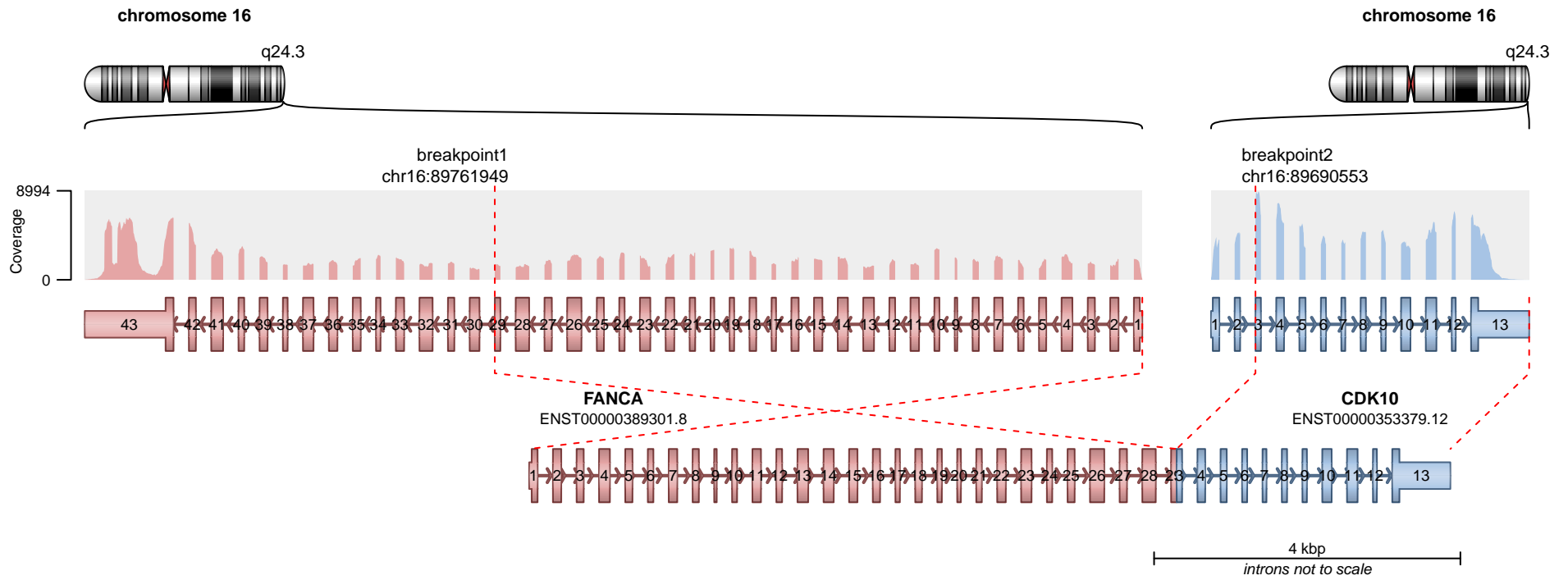

RETAINED PROTEIN DOMAINS
reading frame unclear

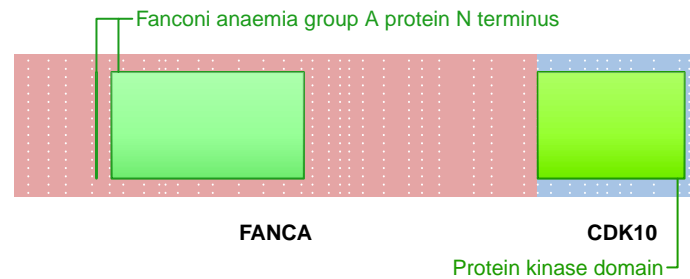

SUPPORTING READ COUNT

Split reads = 3
Discordant mates = 0

- translocation
- duplication
- deletion
- inversion

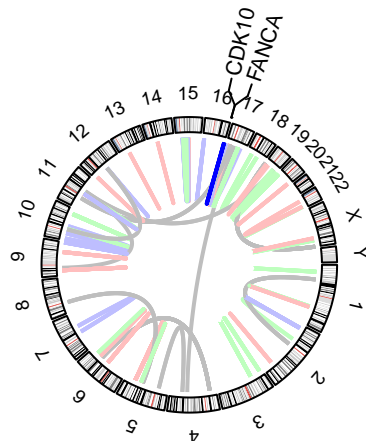
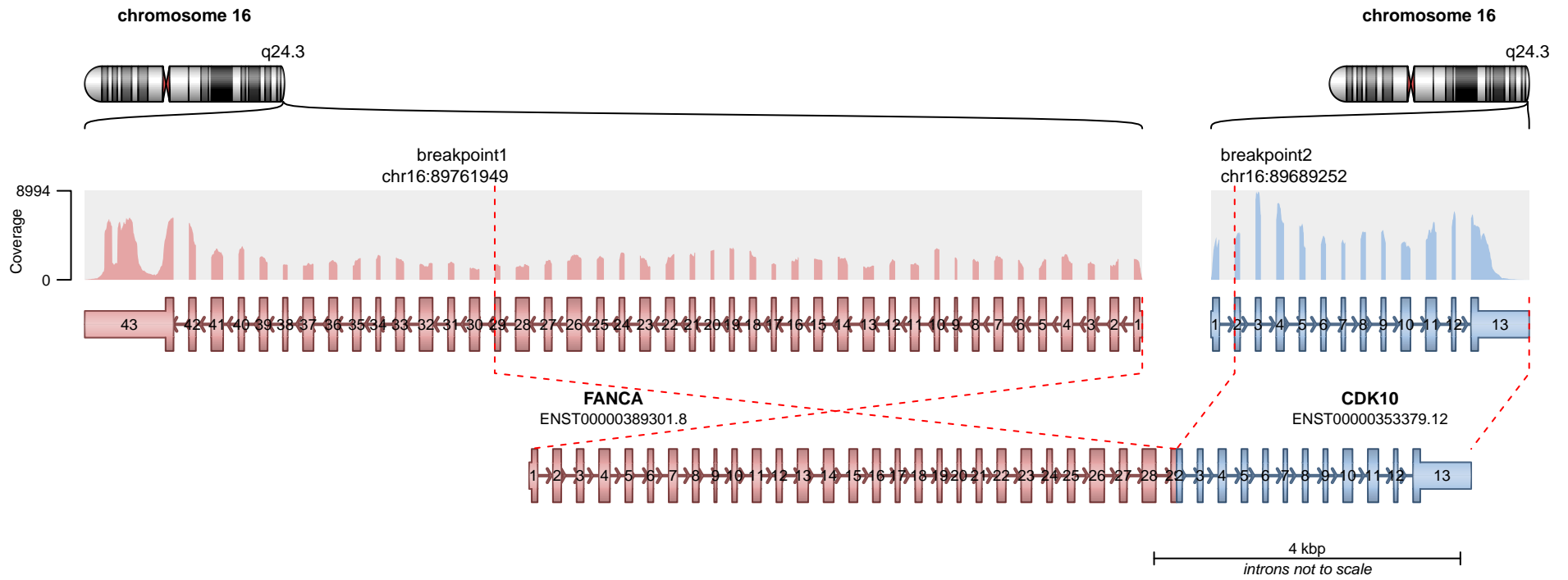

RETAINED PROTEIN DOMAINS
reading frame unclear

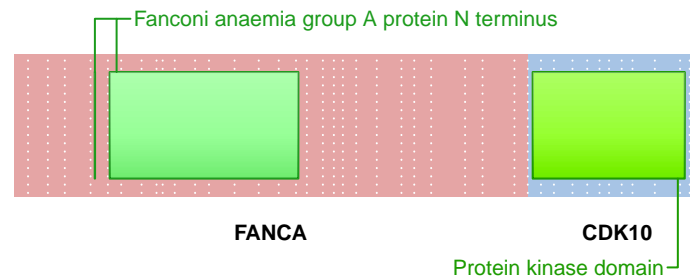

SUPPORTING READ COUNT

Split reads = 1
Discordant mates = 1

- translocation
- duplication
- deletion
- inversion

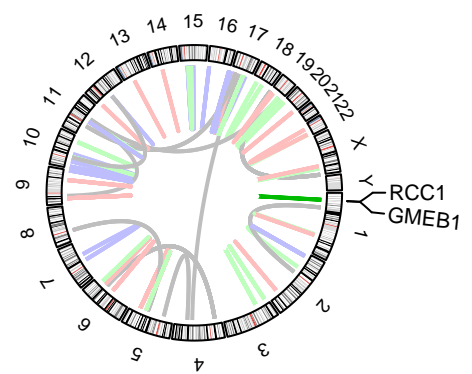
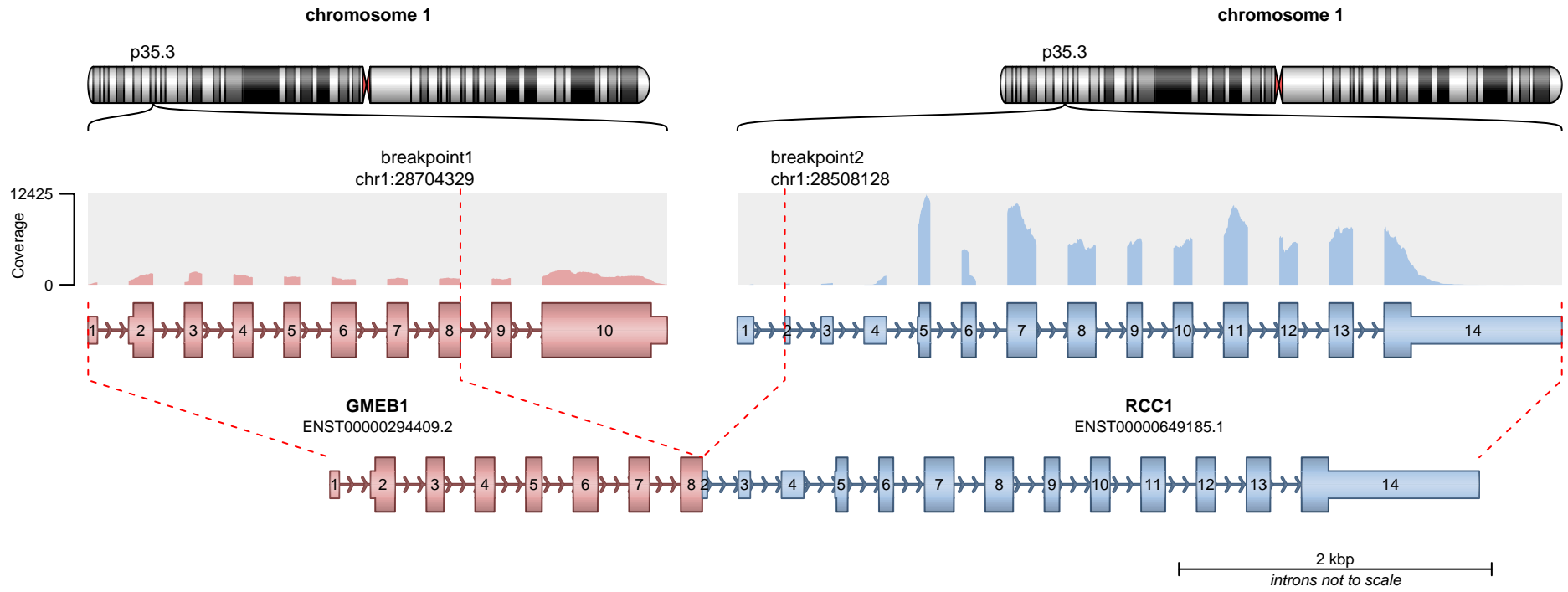

RETAINED PROTEIN DOMAINS
reading frame unclear

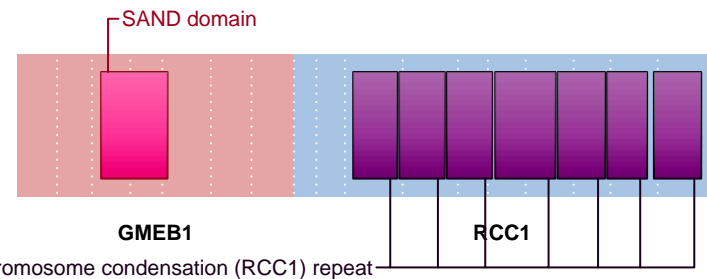

SUPPORTING READ COUNT

Split reads = 17
Discordant mates = 2

- translocation
- duplication
- deletion
- inversion

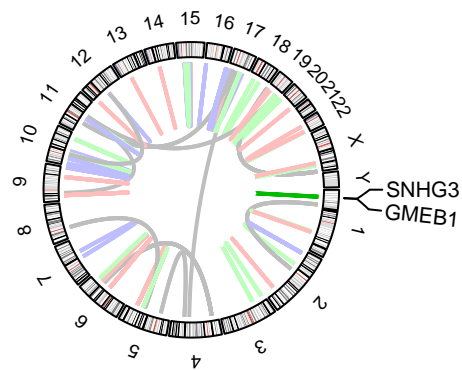
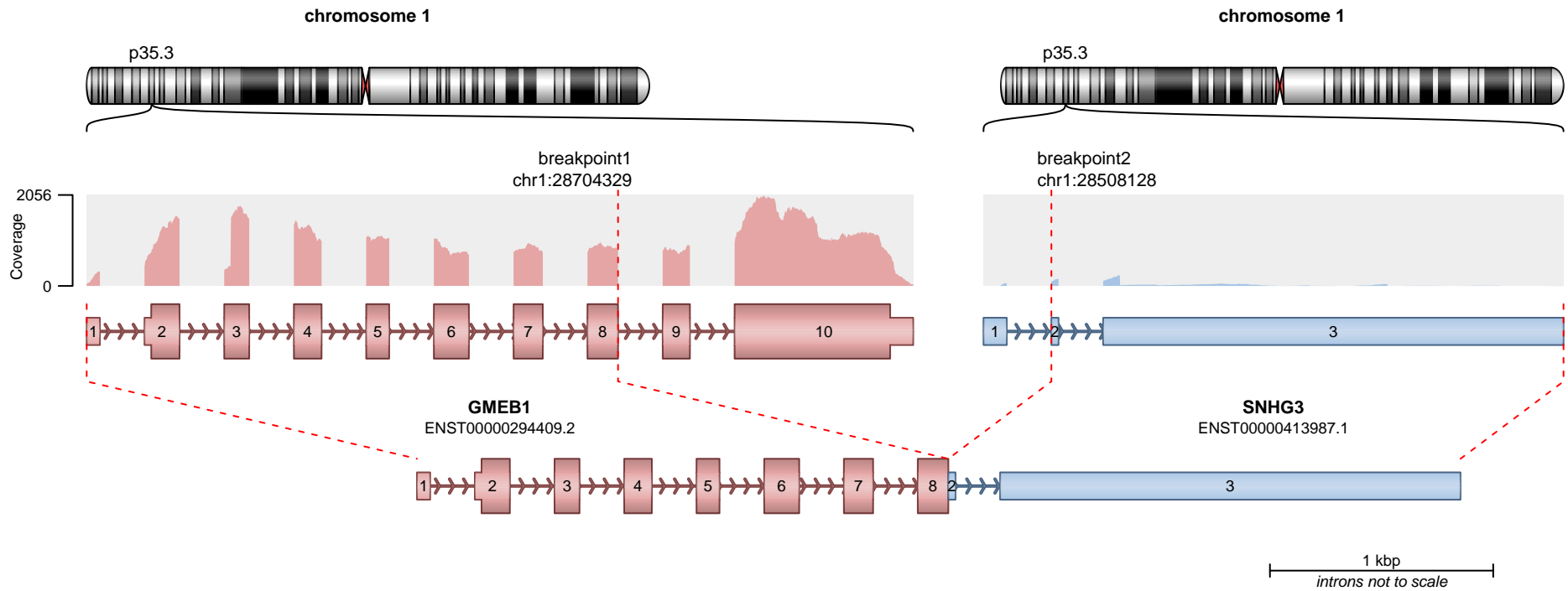

RETAINED PROTEIN DOMAINS
reading frame unclear

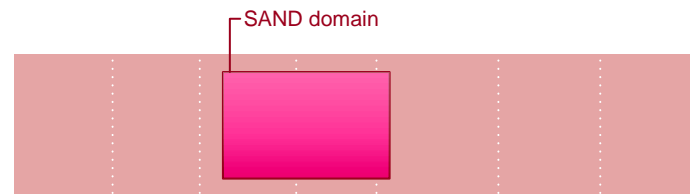

SUPPORTING READ COUNT

Split reads = 17
Discordant mates = 2

- translocation
- duplication
- deletion
- inversion

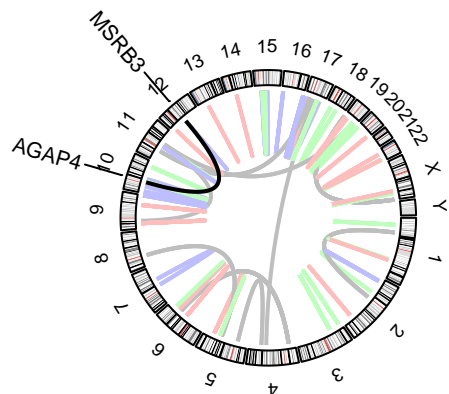
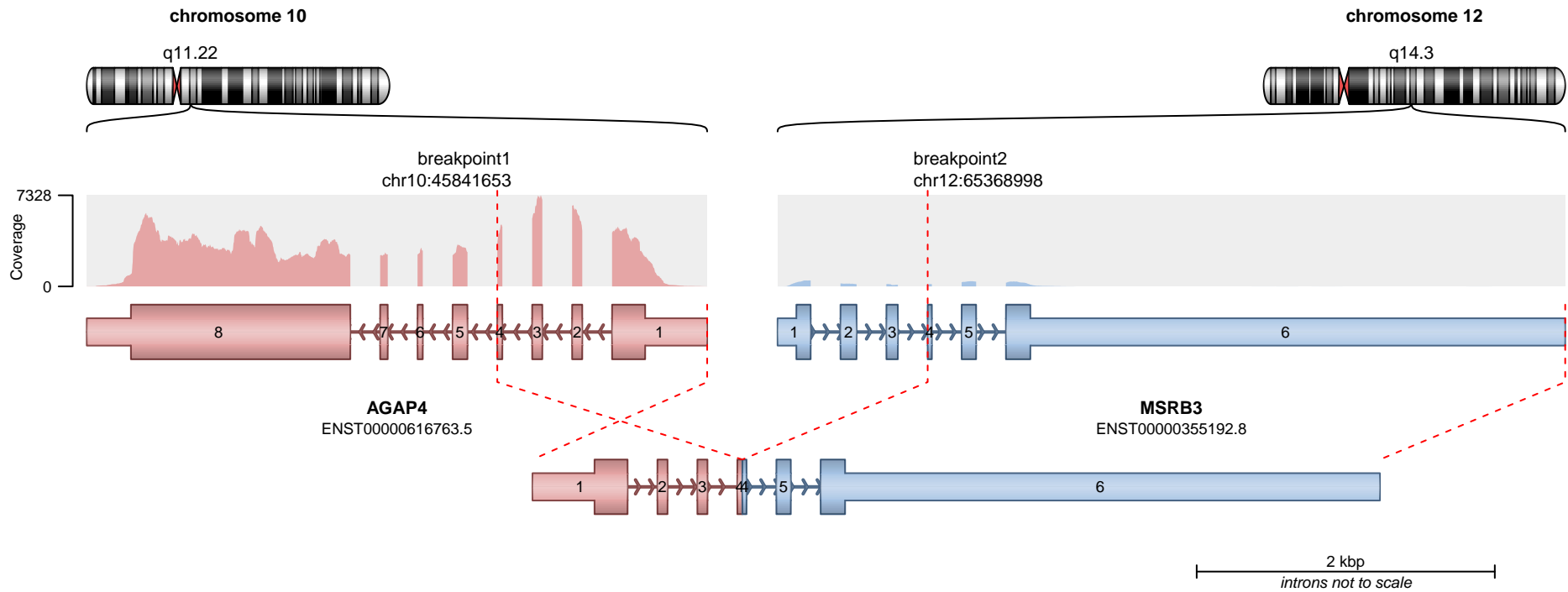

RETAINED PROTEIN DOMAINS
reading frame unclear

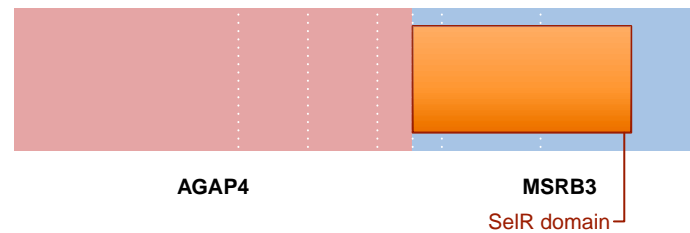

SUPPORTING READ COUNT

Split reads = 17
Discordant mates = 1

— translocation — deletion
— duplication — inversion

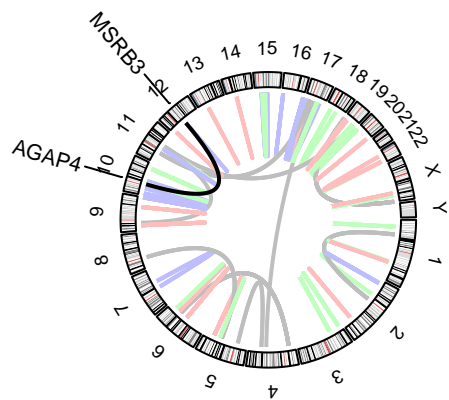
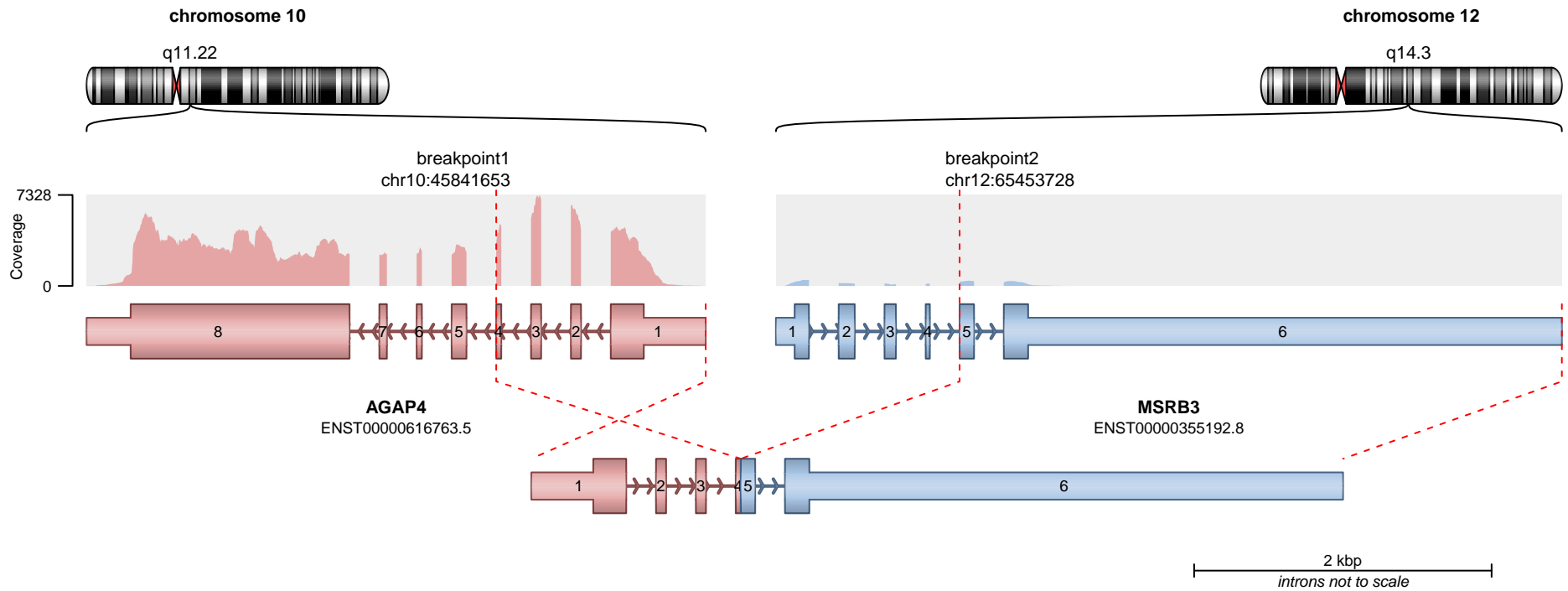

RETAINED PROTEIN DOMAINS
reading frame unclear

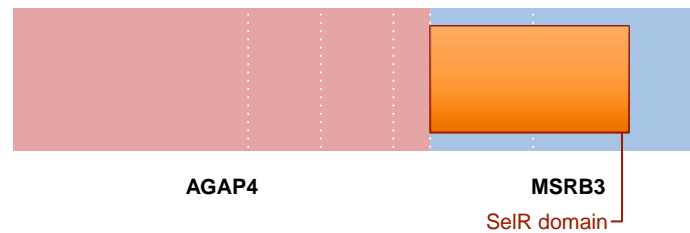

SUPPORTING READ COUNT

Split reads = 1
Discordant mates = 1

— translocation — deletion
— duplication — inversion

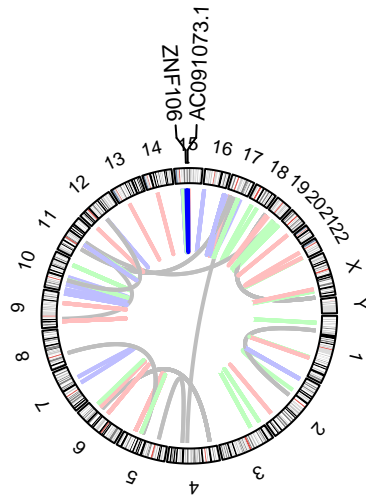
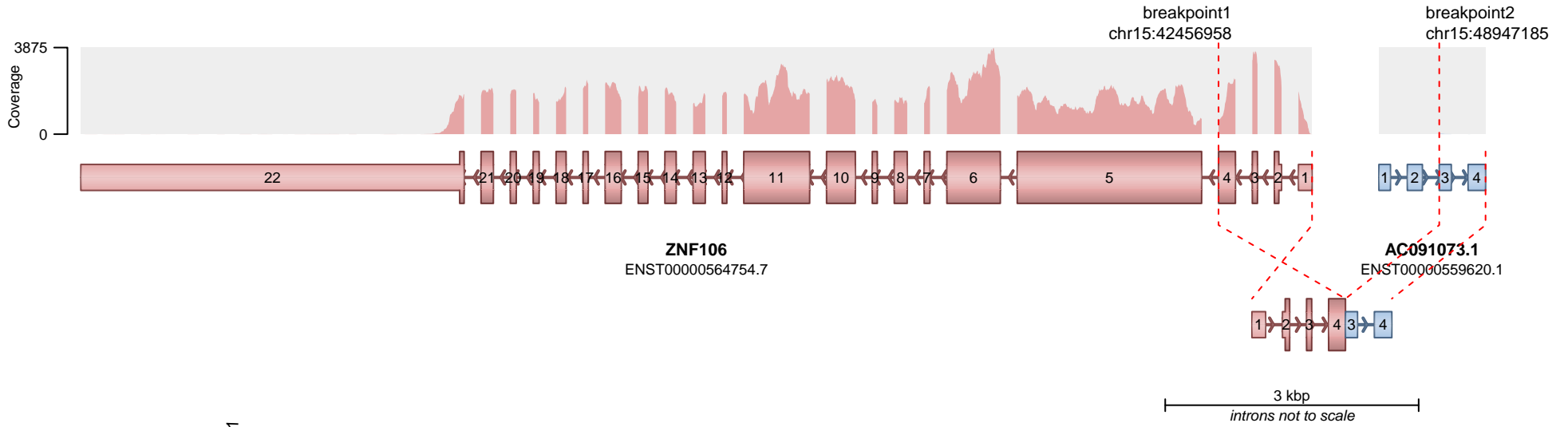
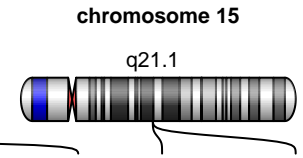
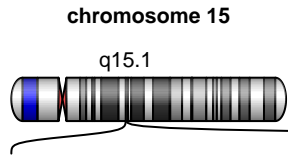

— translocation — deletion
— duplication — inversion

No protein domains retained in fusion.

SUPPORTING READ COUNT

Split reads = 15
Discordant mates = 1

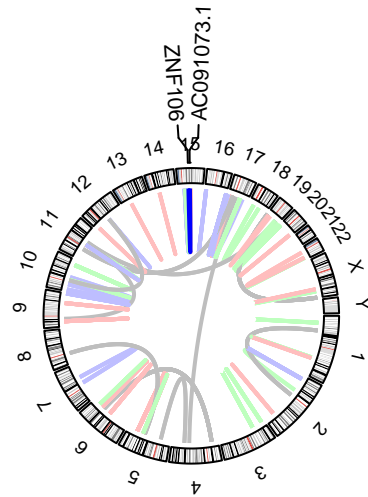
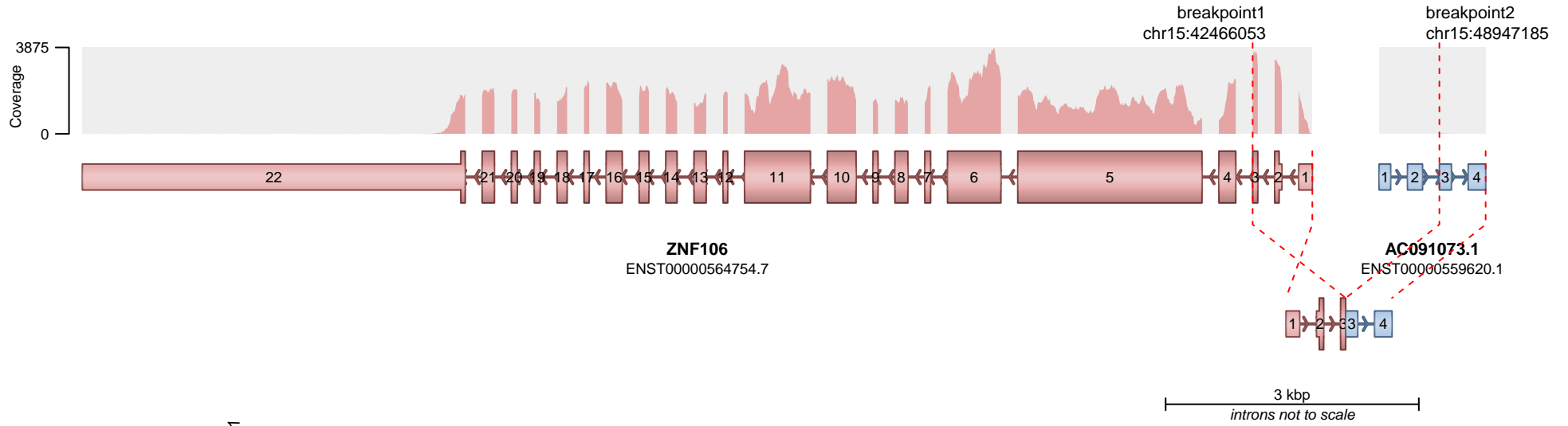
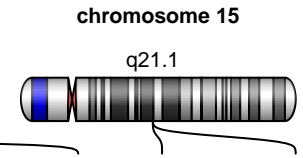
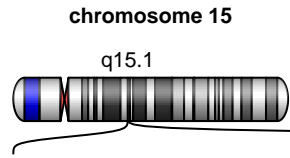

— translocation — deletion
— duplication — inversion

No protein domains retained in fusion.

SUPPORTING READ COUNT

Split reads = 1
Discordant mates = 0

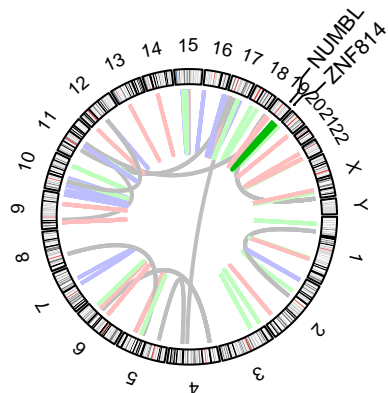
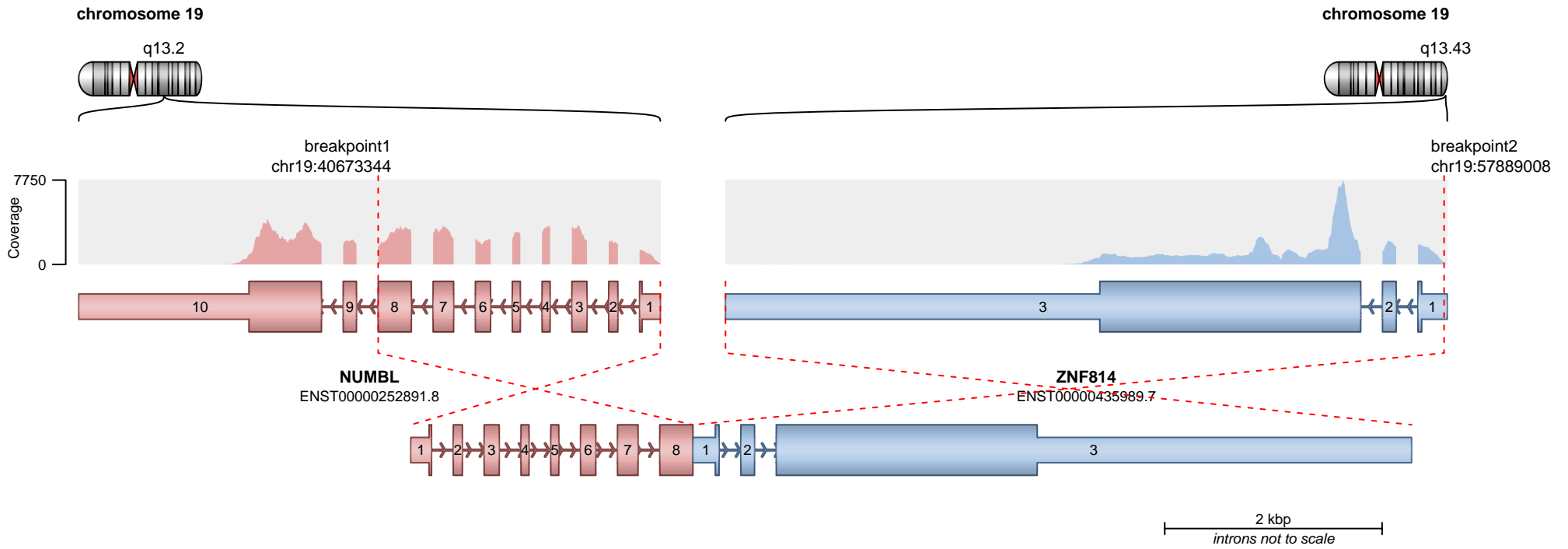

RETAINED PROTEIN DOMAINS
reading frame unclear

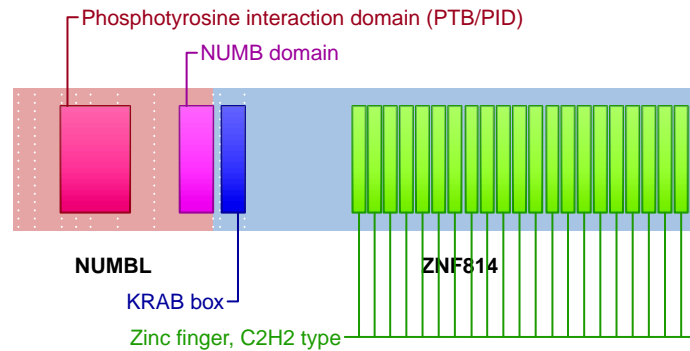

SUPPORTING READ COUNT

Split reads = 12
Discordant mates = 5

— translocation — deletion
— duplication — inversion

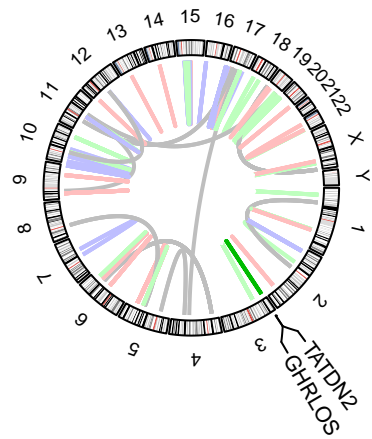
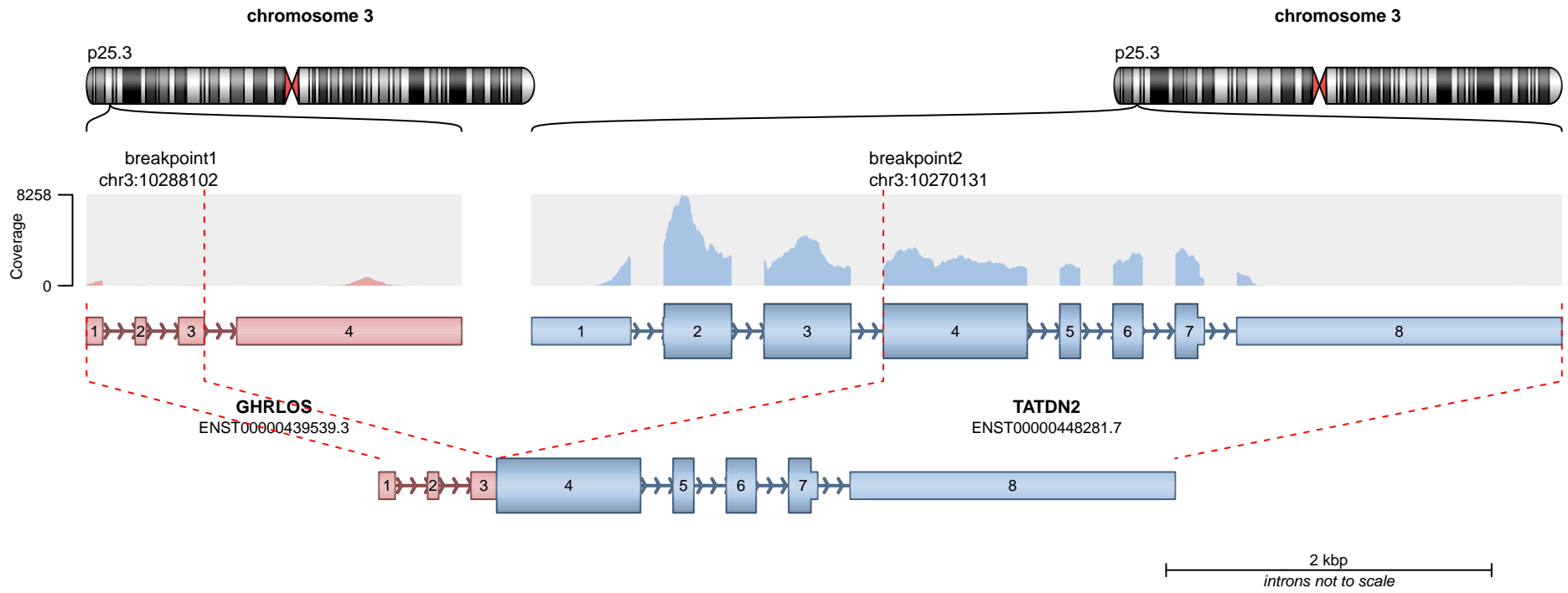

RETAINED PROTEIN DOMAINS
reading frame unclear

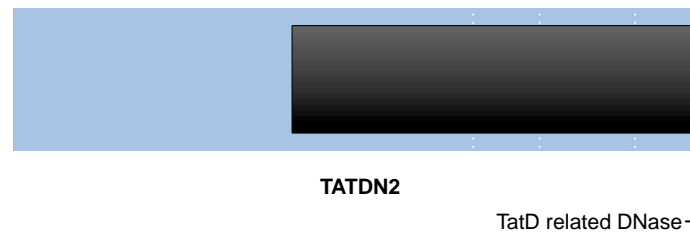

SUPPORTING READ COUNT

Split reads = 13
Discordant mates = 0

— translocation — deletion
— duplication — inversion

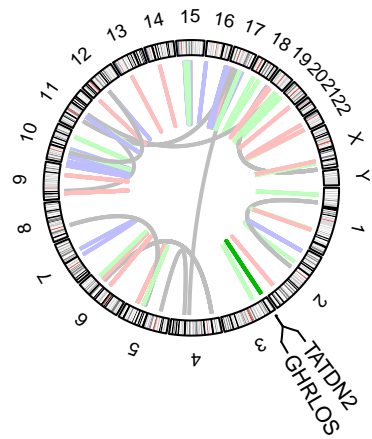
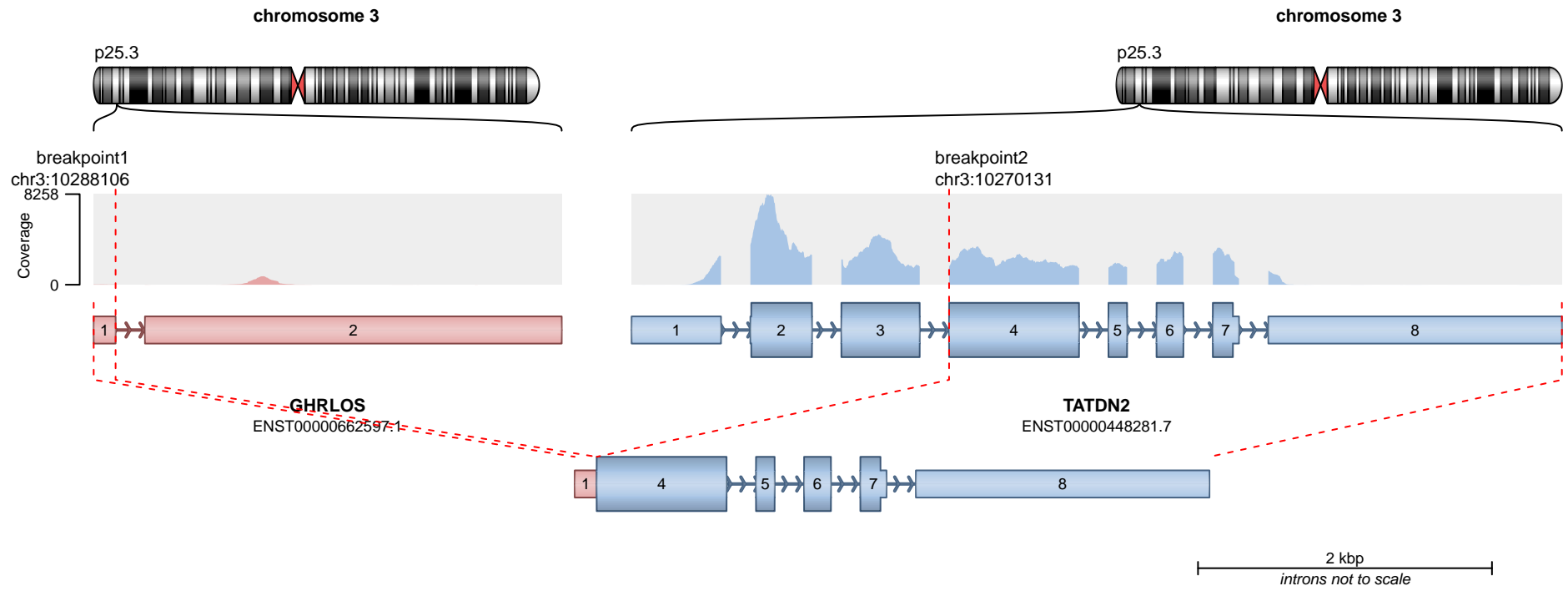

— translocation — deletion
— duplication — inversion

RETAINED PROTEIN DOMAINS
reading frame unclear

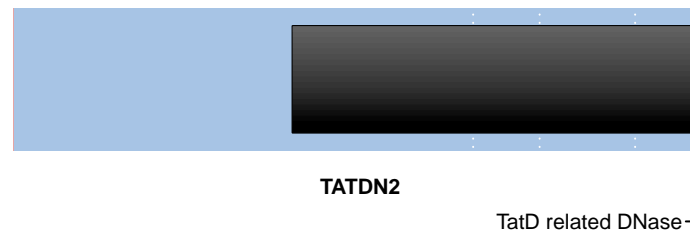

SUPPORTING READ COUNT

Split reads = 4
Discordant mates = 0

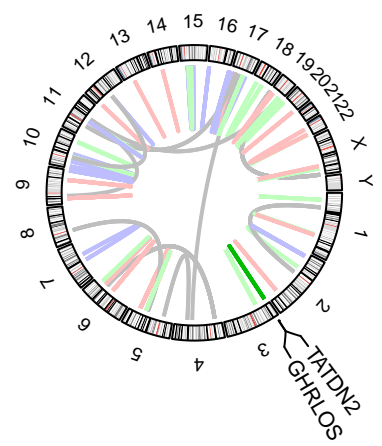
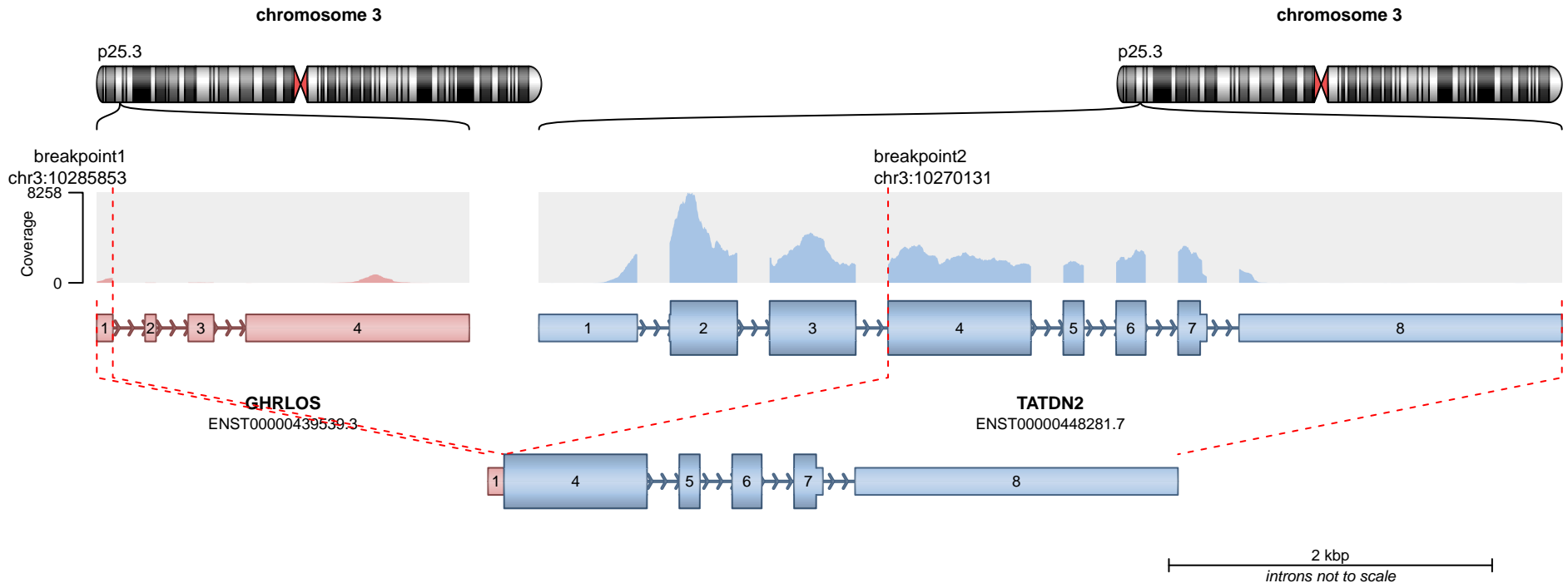

— translocation — deletion
— duplication — inversion

RETAINED PROTEIN DOMAINS
reading frame unclear

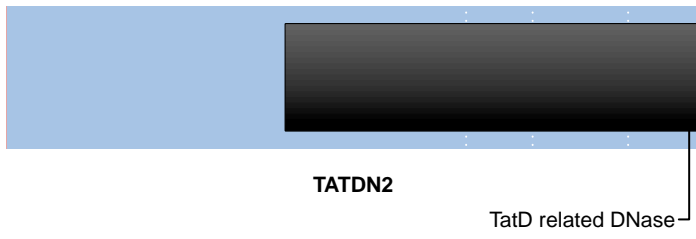

SUPPORTING READ COUNT

Split reads = 3
Discordant mates = 0

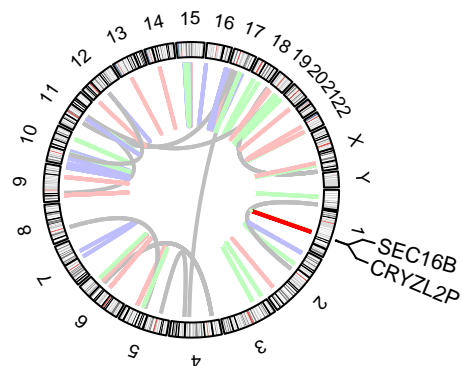
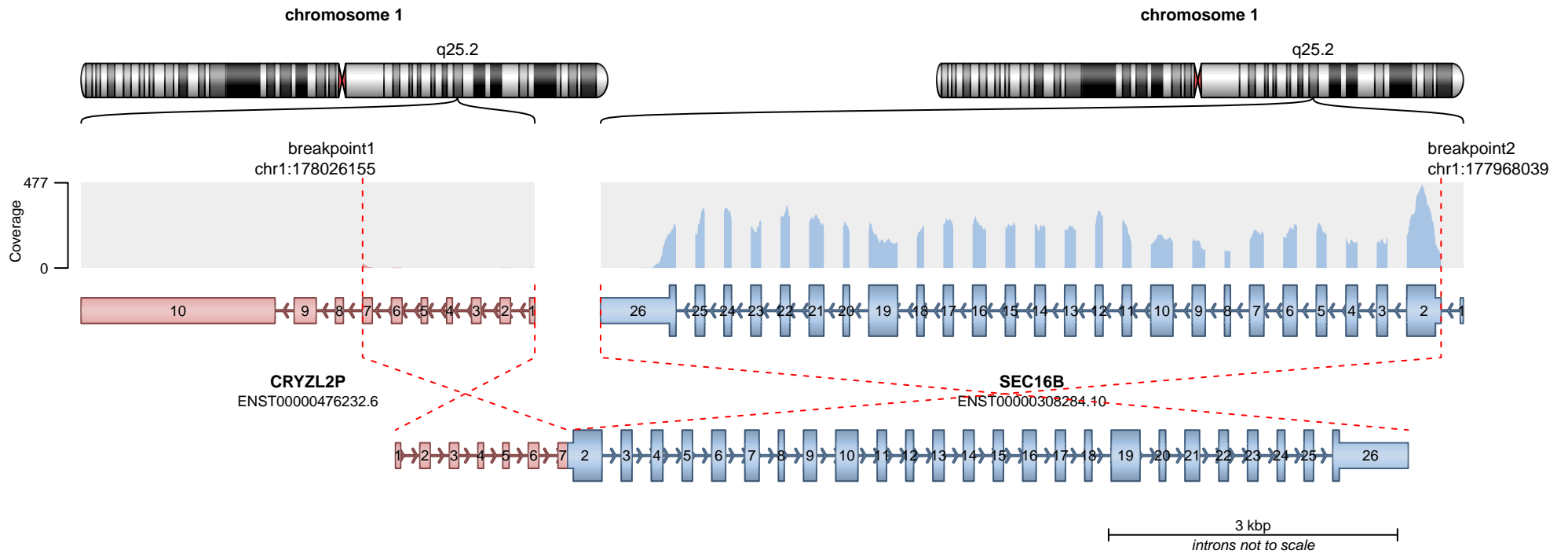

RETAINED PROTEIN DOMAINS
reading frame unclear

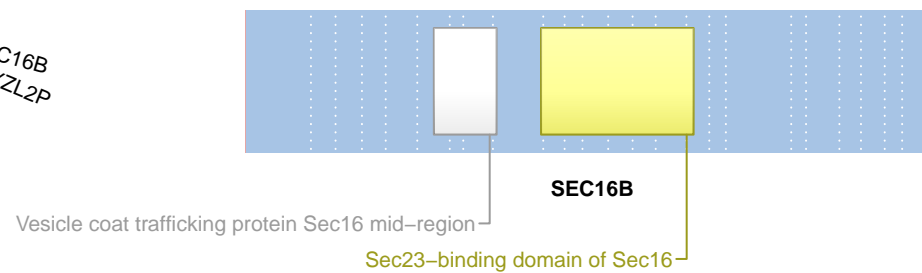

SUPPORTING READ COUNT

Split reads = 12
Discordant mates = 0

- translocation
- duplication
- deletion
- inversion

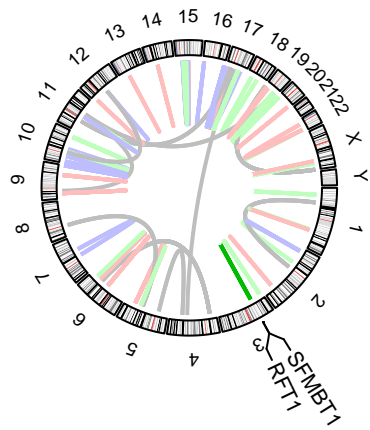
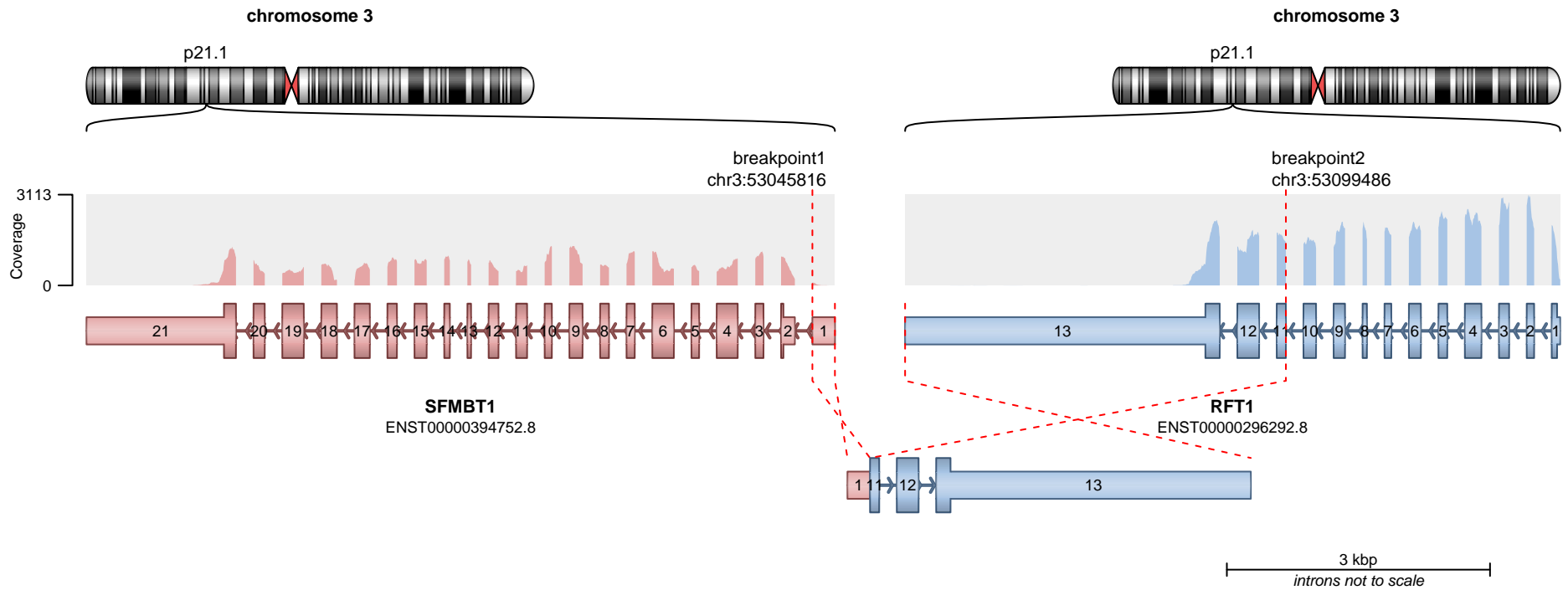

— translocation — deletion
— duplication — inversion

RETAINED PROTEIN DOMAINS
reading frame unclear

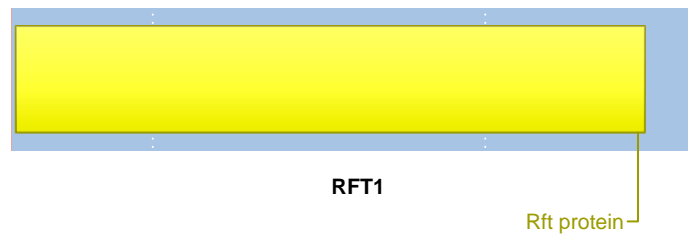

SUPPORTING READ COUNT

Split reads = 10
Discordant mates = 1

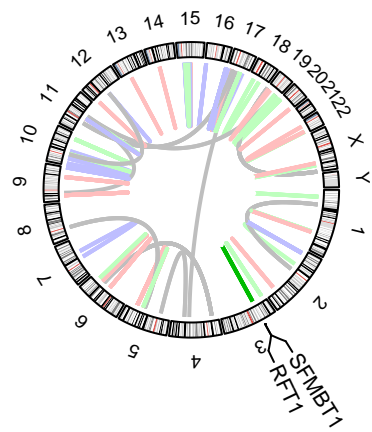
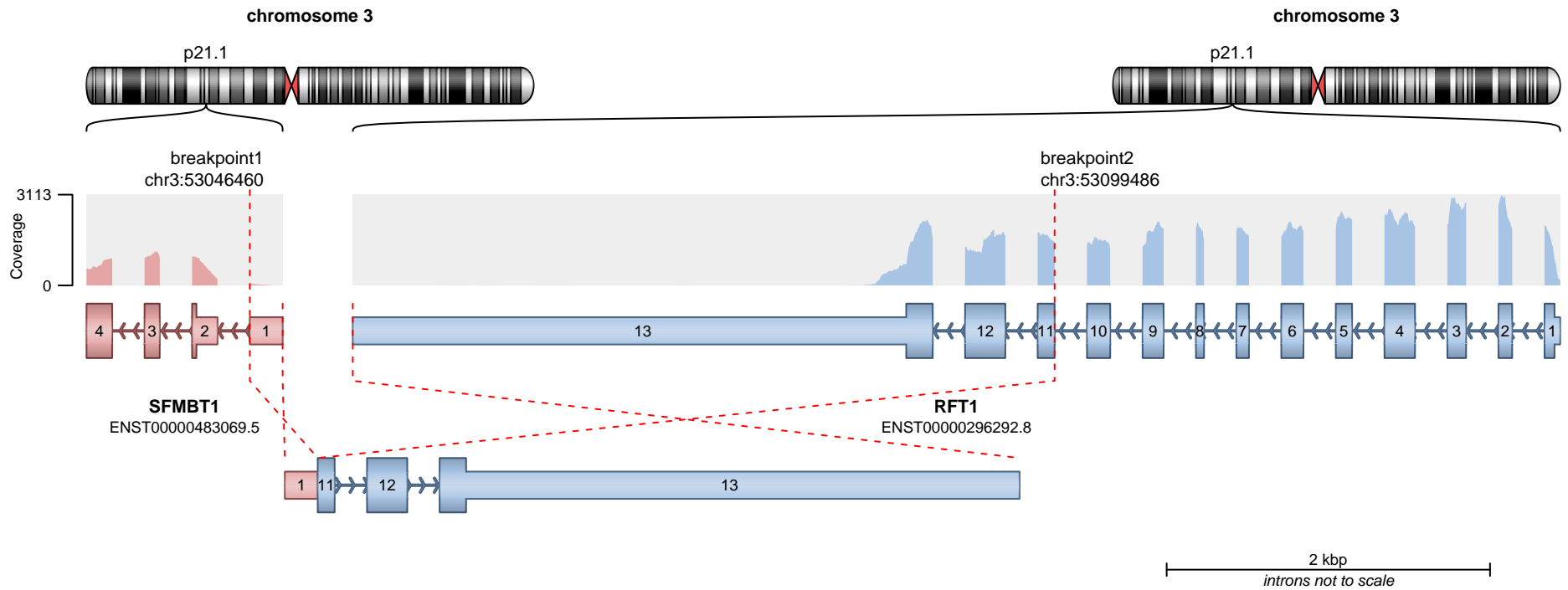

— translocation — deletion
— duplication — inversion

RETAINED PROTEIN DOMAINS
reading frame unclear

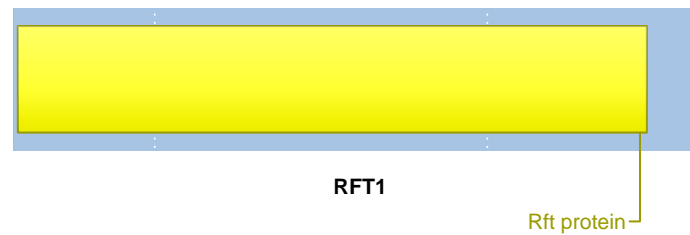

SUPPORTING READ COUNT

Split reads = 5
Discordant mates = 1

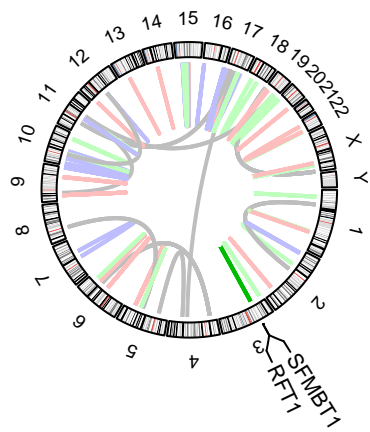
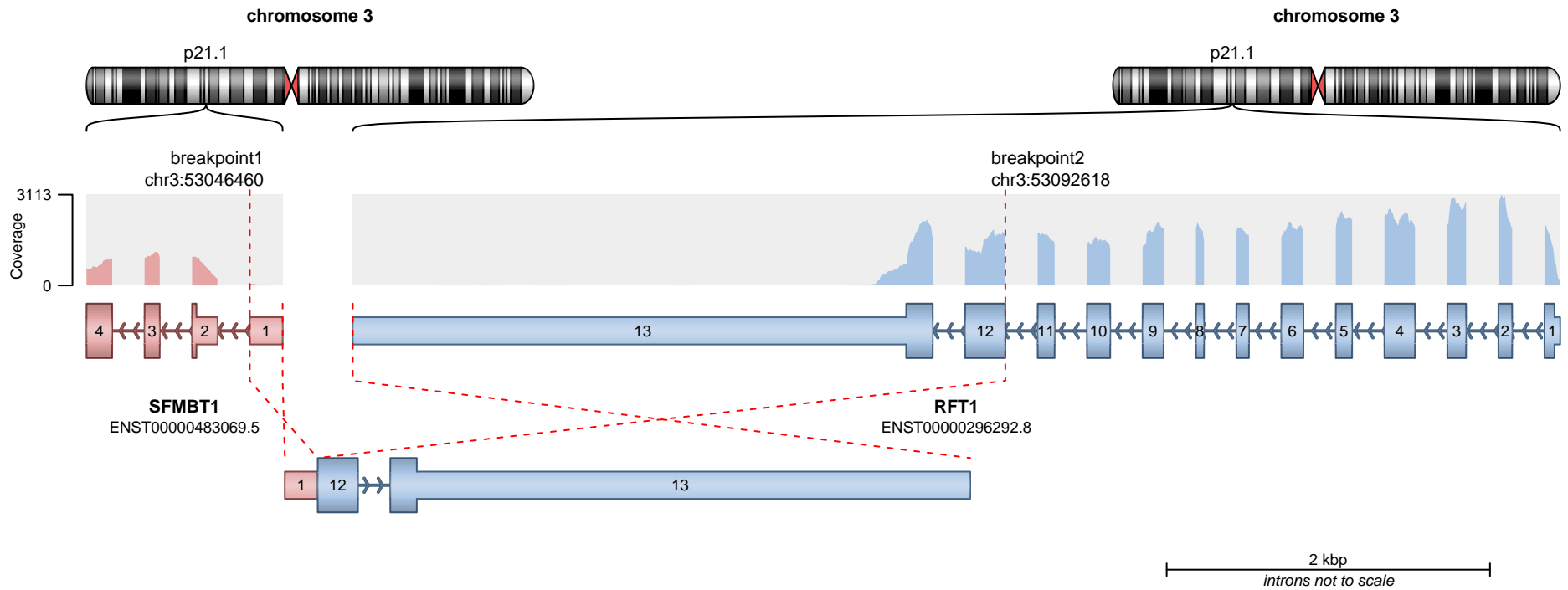

RETAINED PROTEIN DOMAINS
reading frame unclear

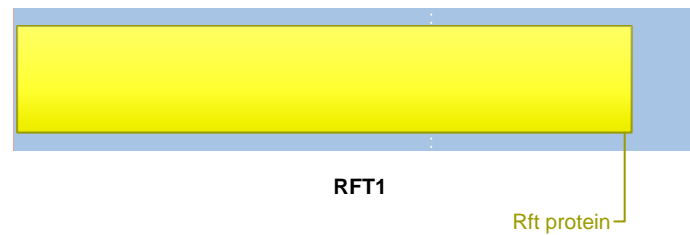

SUPPORTING READ COUNT

Split reads = 1
Discordant mates = 0

— translocation — deletion
— duplication — inversion

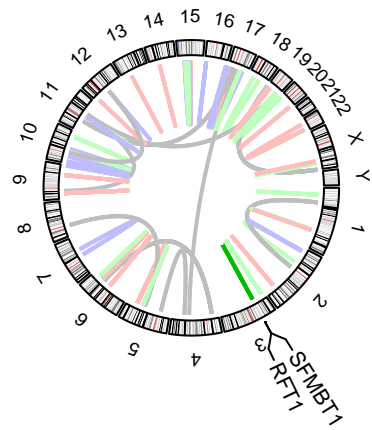
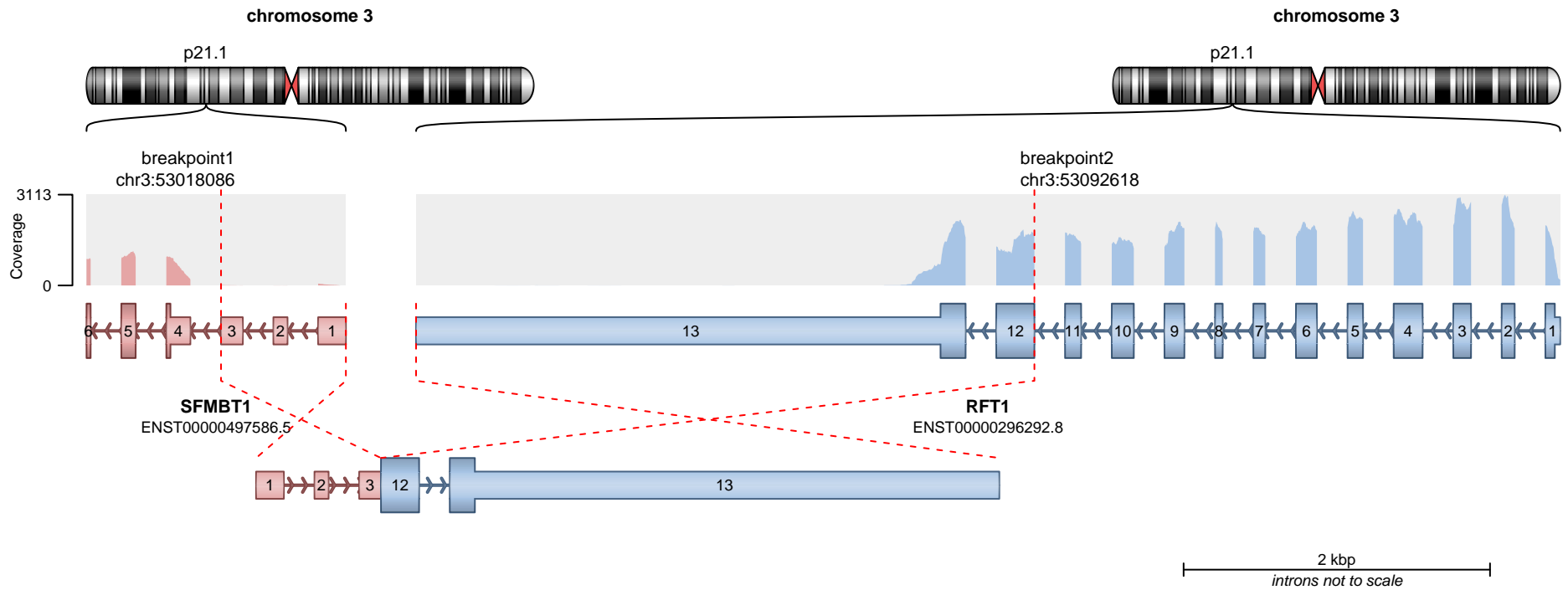

— translocation — deletion
— duplication — inversion

RETAINED PROTEIN DOMAINS
reading frame unclear

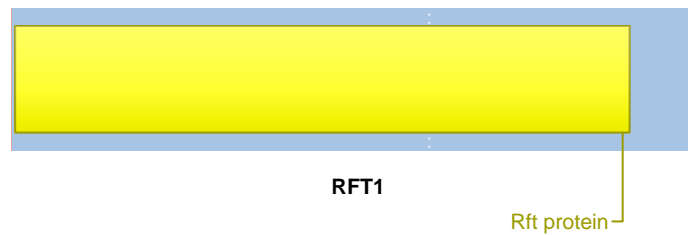

SUPPORTING READ COUNT

Split reads = 1
Discordant mates = 0

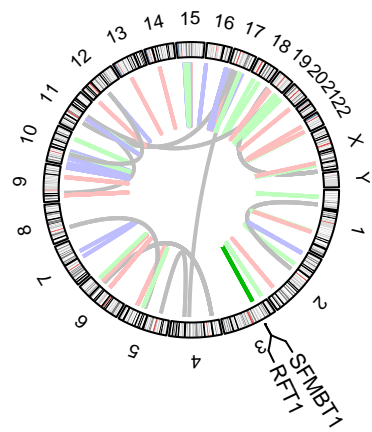
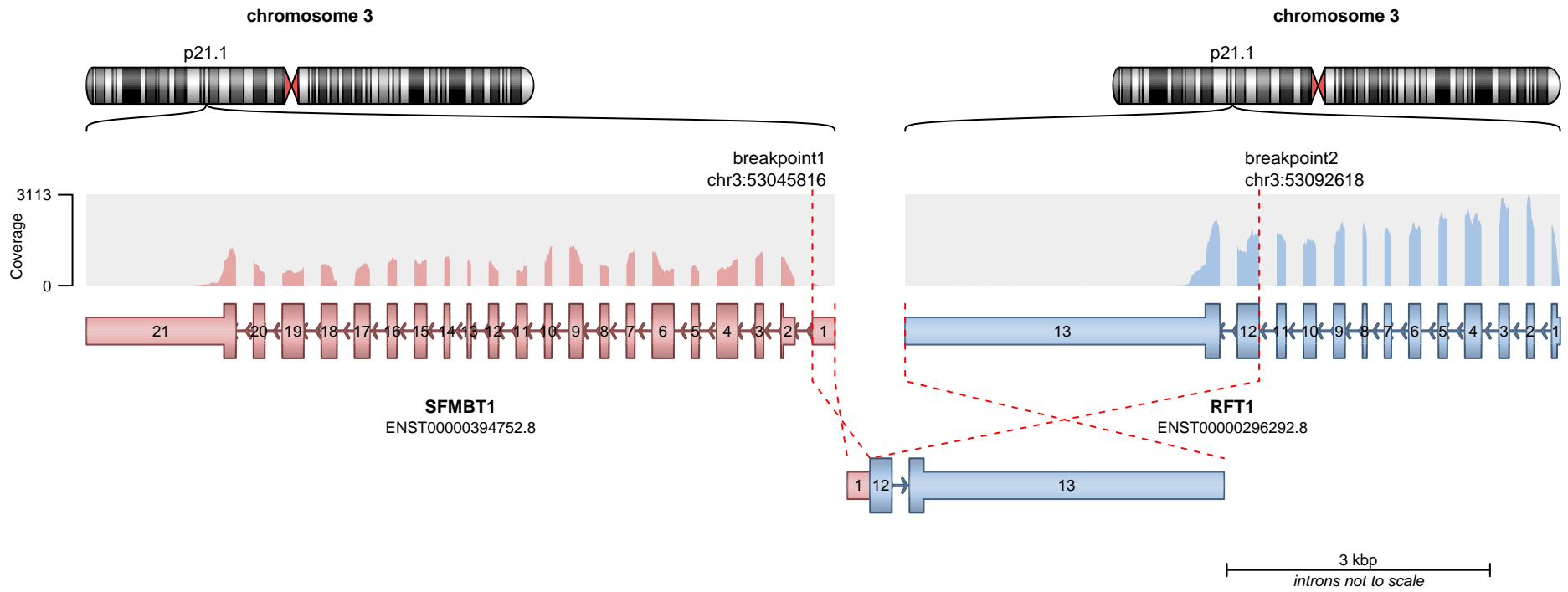

— translocation — deletion
— duplication — inversion

RETAINED PROTEIN DOMAINS
reading frame unclear

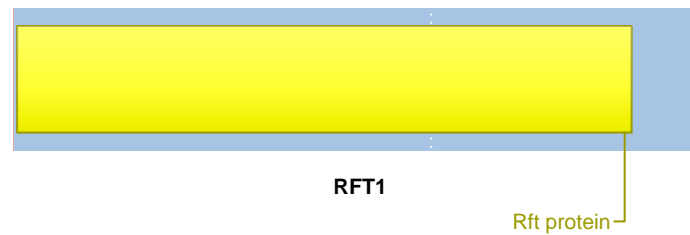

SUPPORTING READ COUNT

Split reads = 1
Discordant mates = 0

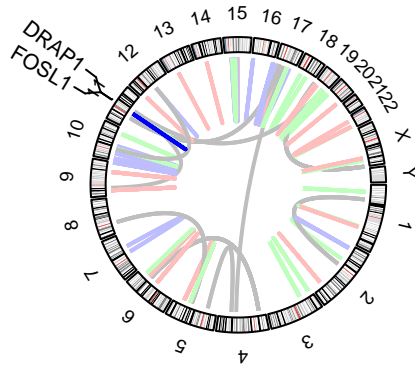
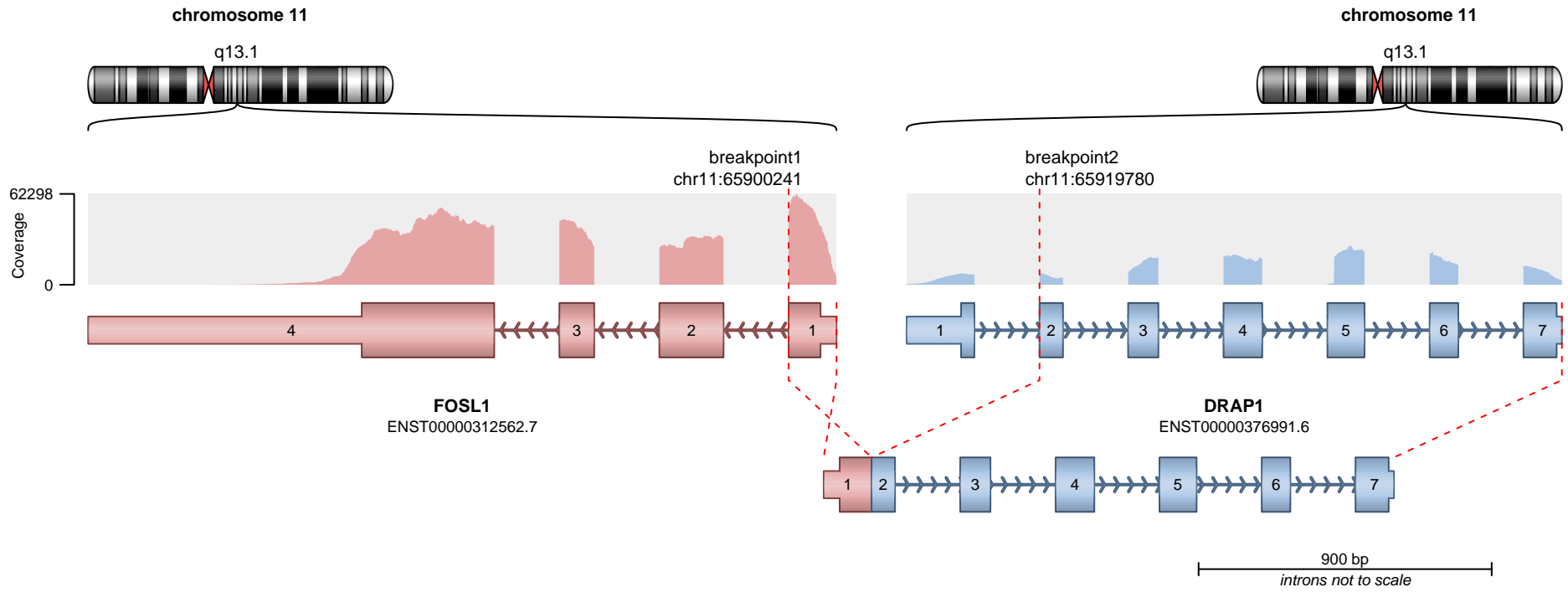

Histone-like transcription factor (CBF/NF- κ B) and archaeal histone

RETAINED PROTEIN DOMAINS
reading frame unclear

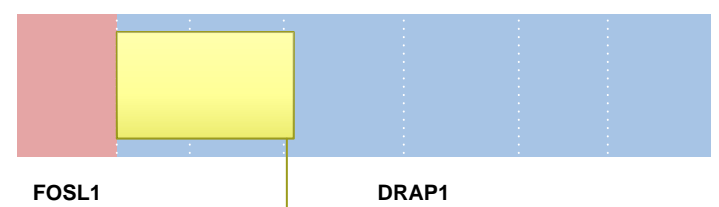

SUPPORTING READ COUNT

Split reads = 10
Discordant mates = 0

- translocation
- duplication
- deletion
- inversion

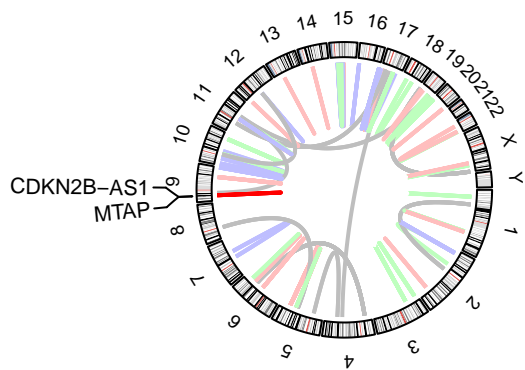
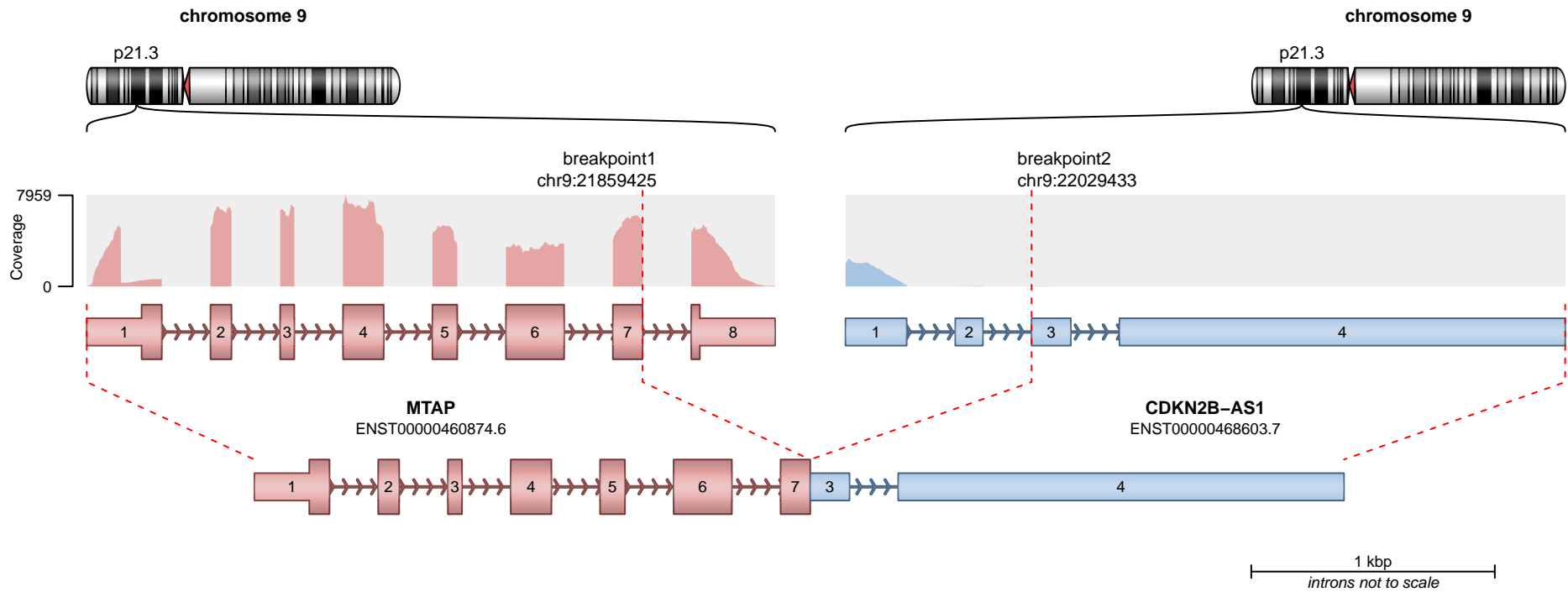

RETAINED PROTEIN DOMAINS
reading frame unclear

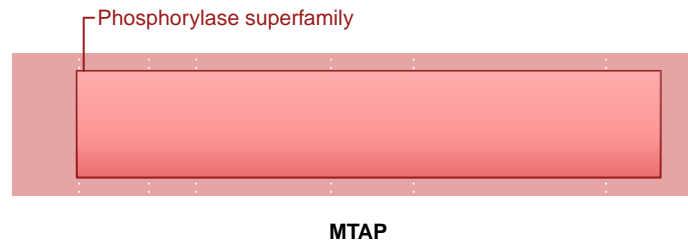

SUPPORTING READ COUNT

Split reads = 10
Discordant mates = 0

- translocation
- duplication
- deletion
- inversion

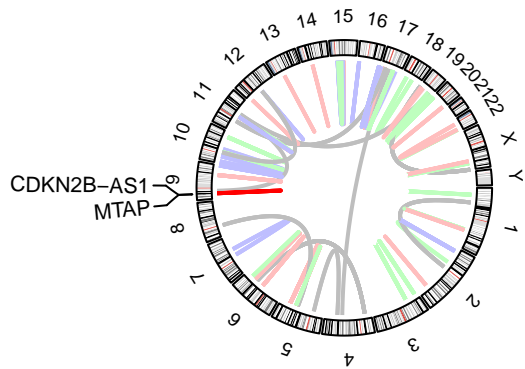
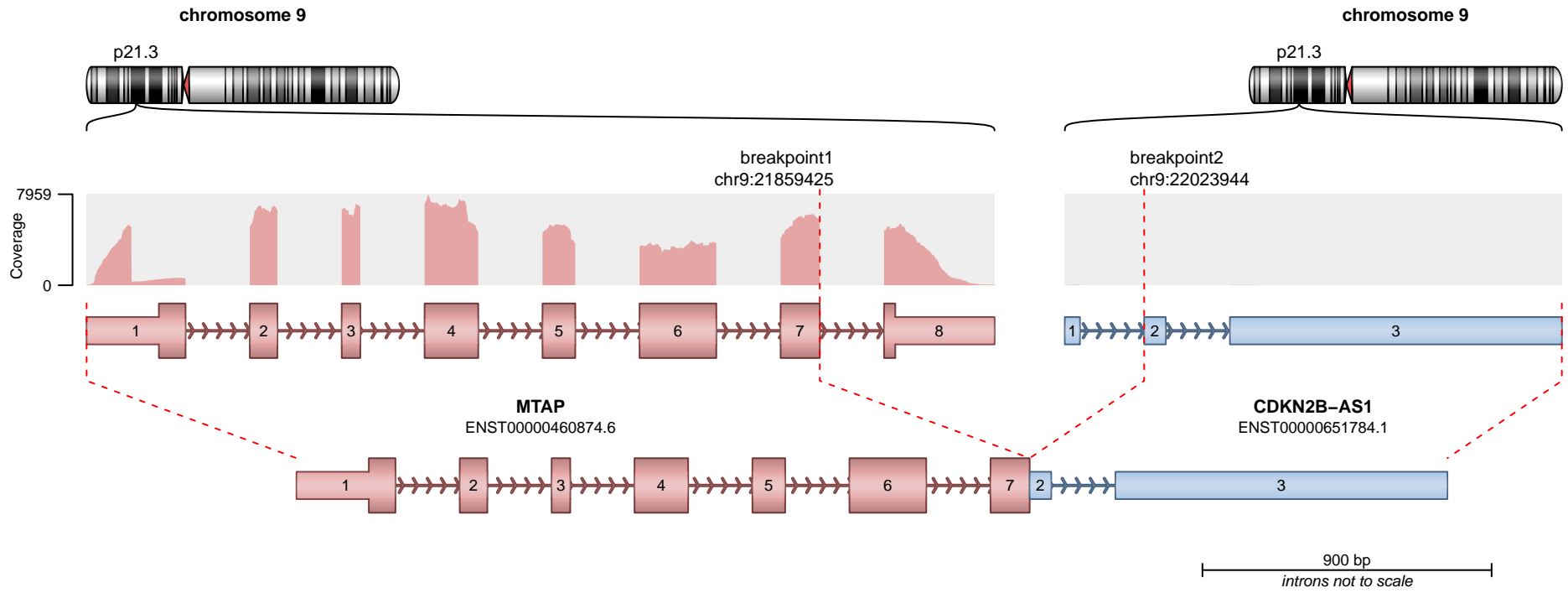

RETAINED PROTEIN DOMAINS
reading frame unclear

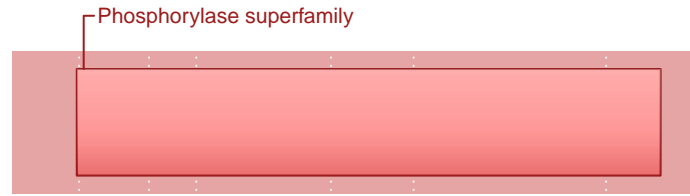

MTAP

SUPPORTING READ COUNT

Split reads = 3
Discordant mates = 0

- translocation
- duplication
- deletion
- inversion

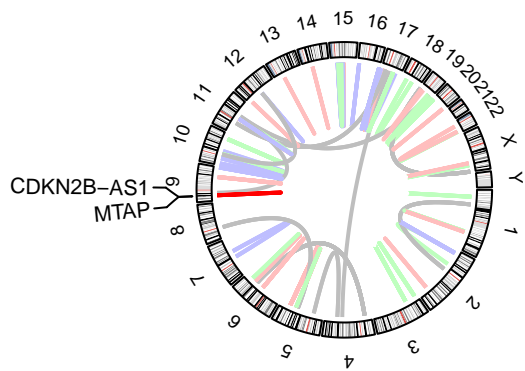
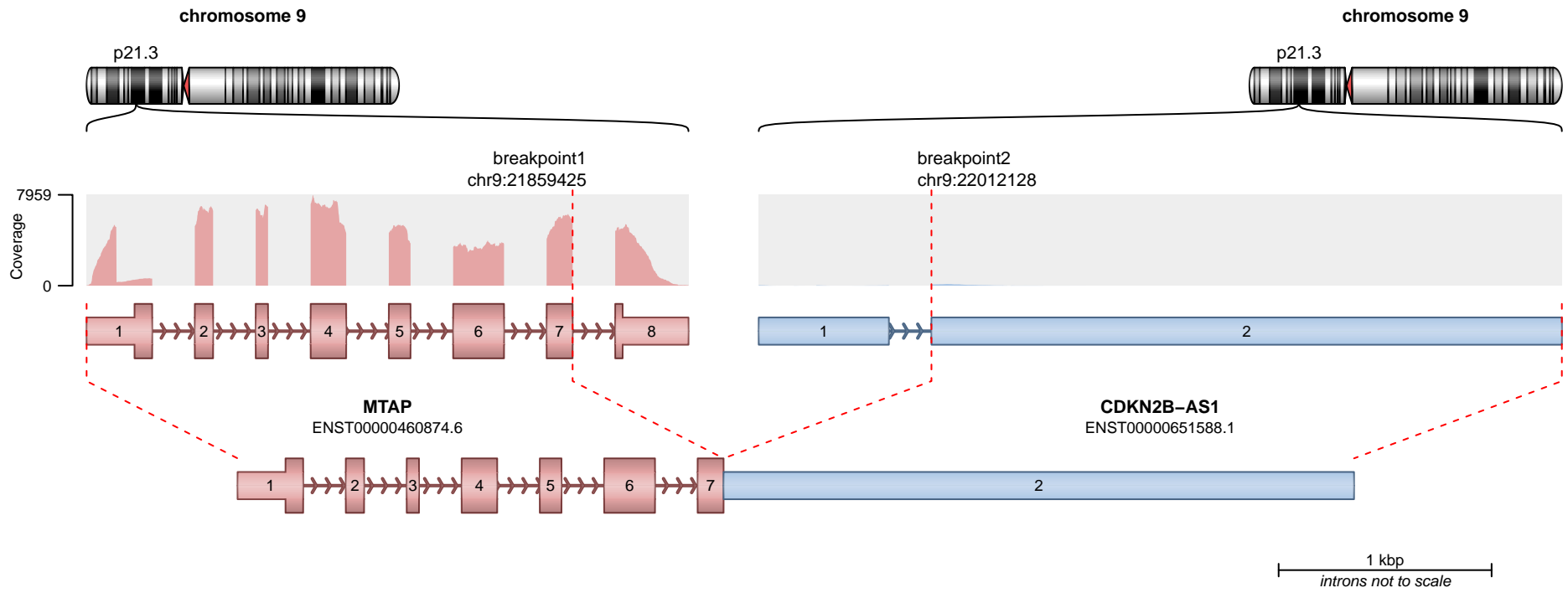

RETAINED PROTEIN DOMAINS
reading frame unclear

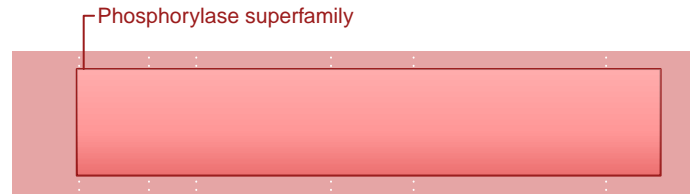

MTAP

SUPPORTING READ COUNT

Split reads = 3
Discordant mates = 0

— translocation — deletion
— duplication — inversion

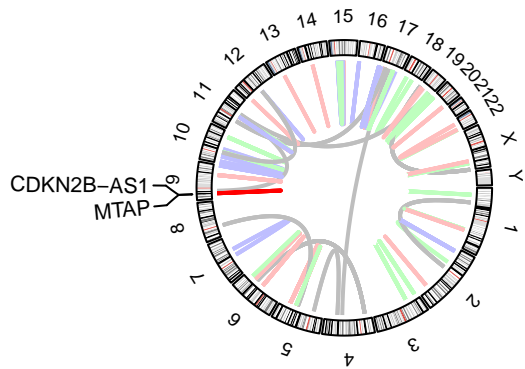
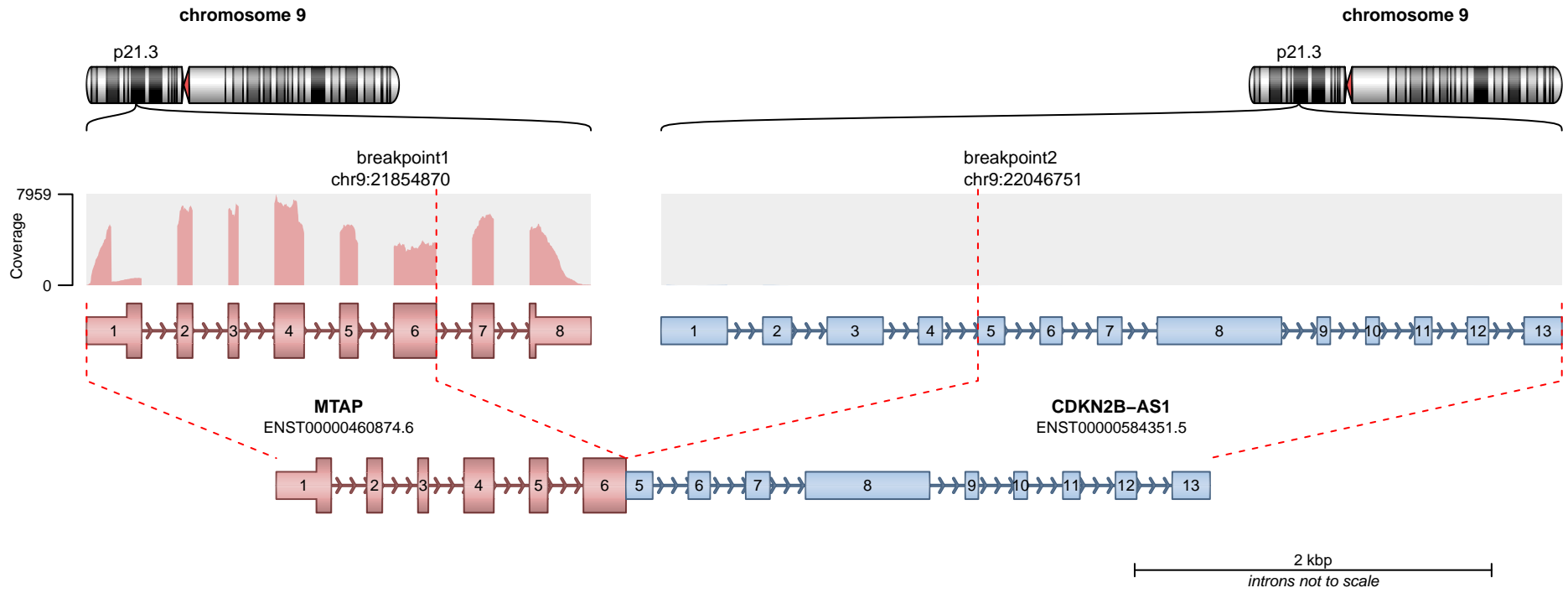

RETAINED PROTEIN DOMAINS
reading frame unclear

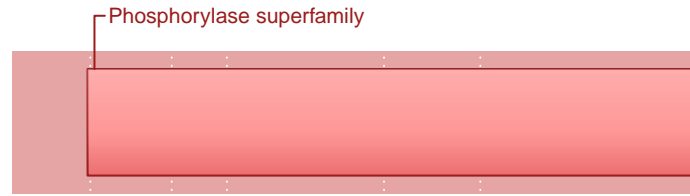

MTAP

SUPPORTING READ COUNT

Split reads = 2
Discordant mates = 0

- translocation
- duplication
- deletion
- inversion

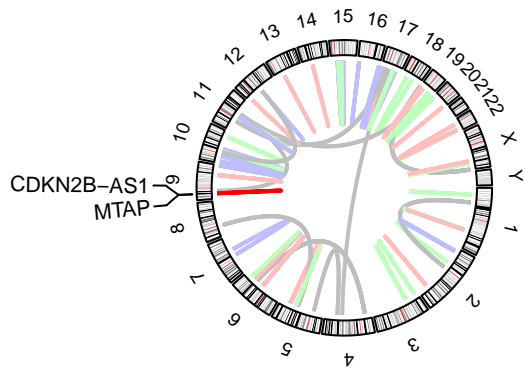
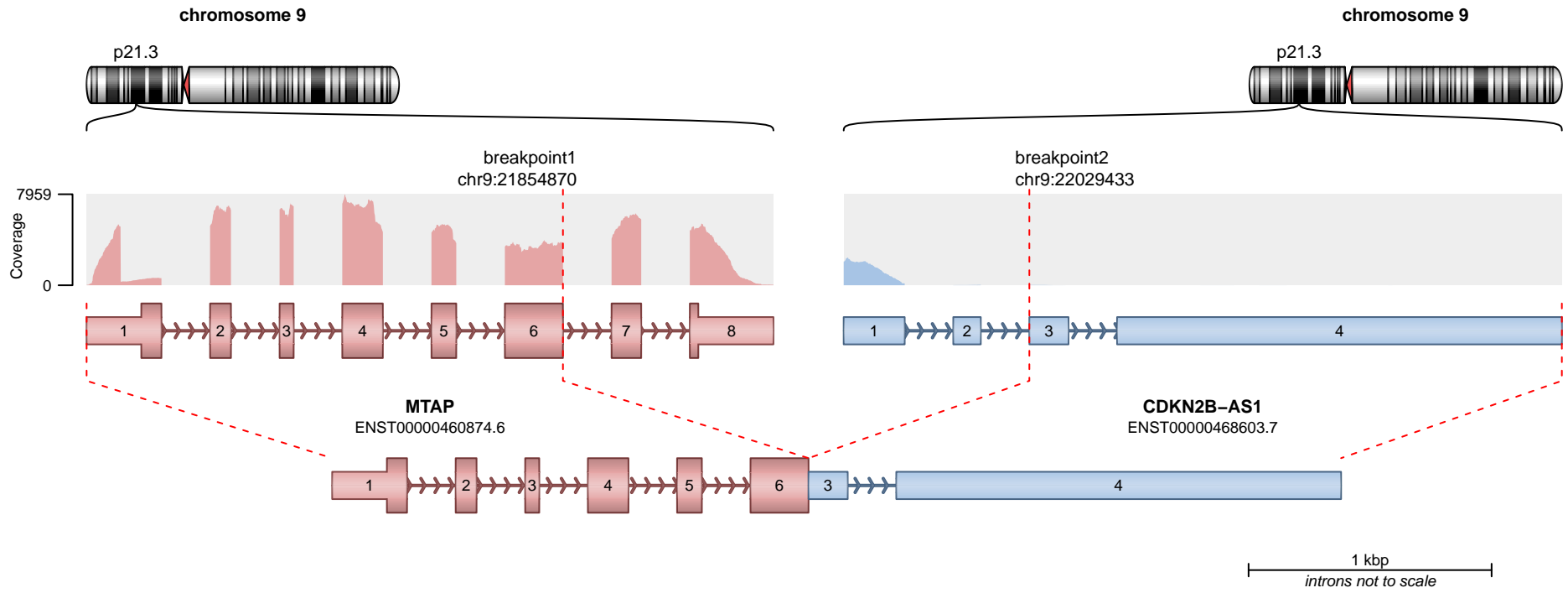

RETAINED PROTEIN DOMAINS
reading frame unclear

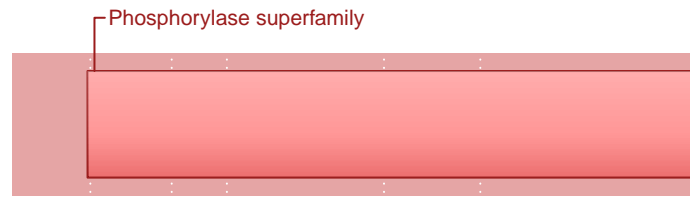

SUPPORTING READ COUNT

Split reads = 1
Discordant mates = 0

- translocation
- duplication
- deletion
- inversion

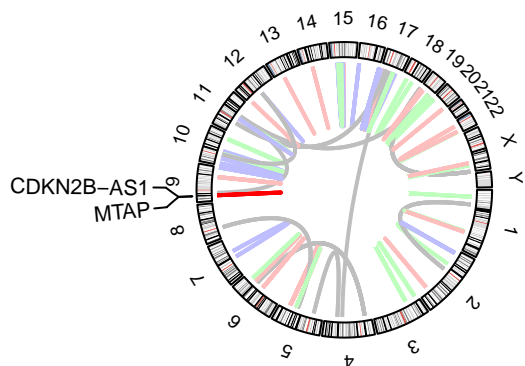
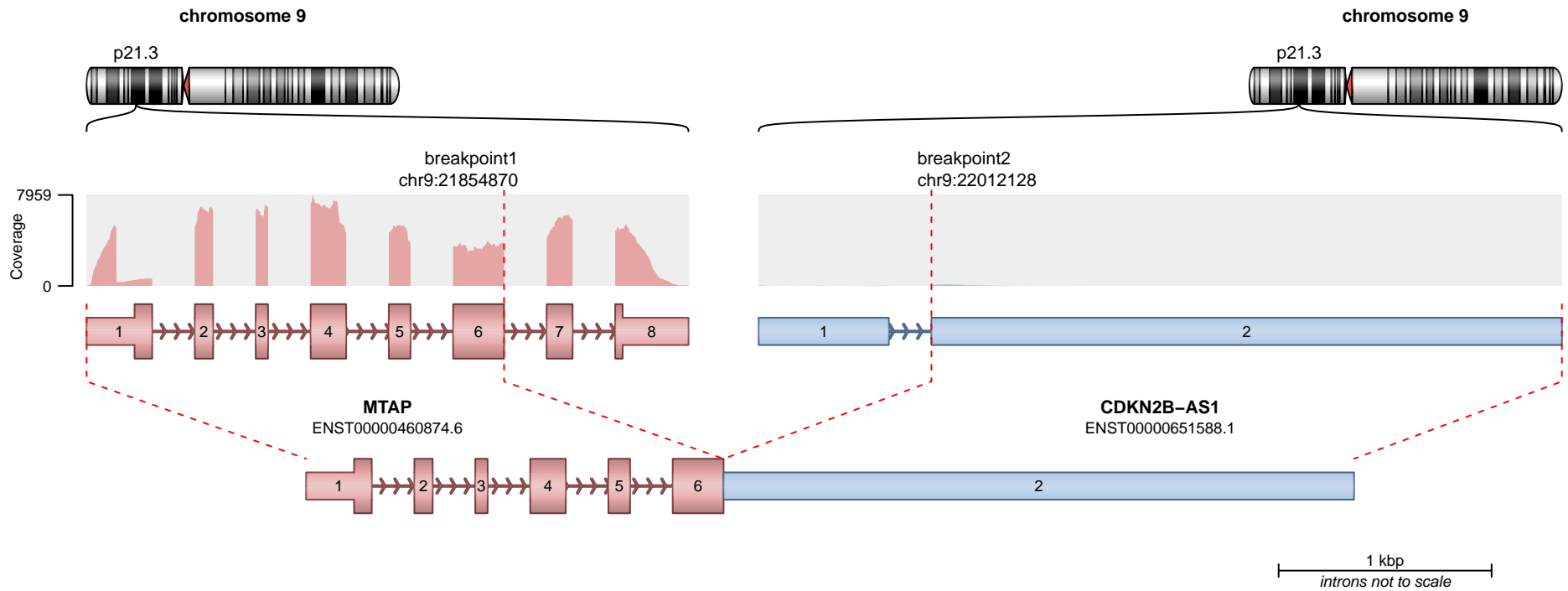

RETAINED PROTEIN DOMAINS
reading frame unclear

Phosphorylase superfamily



MTAP

SUPPORTING READ COUNT

Split reads = 1
Discordant mates = 0

— translocation — deletion
— duplication — inversion

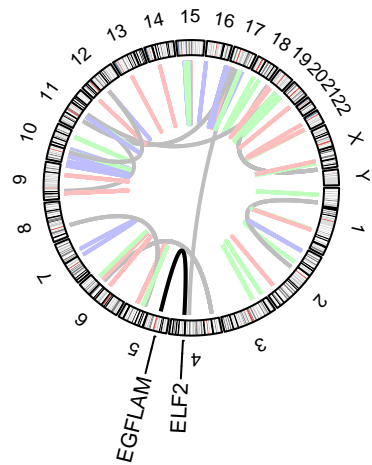
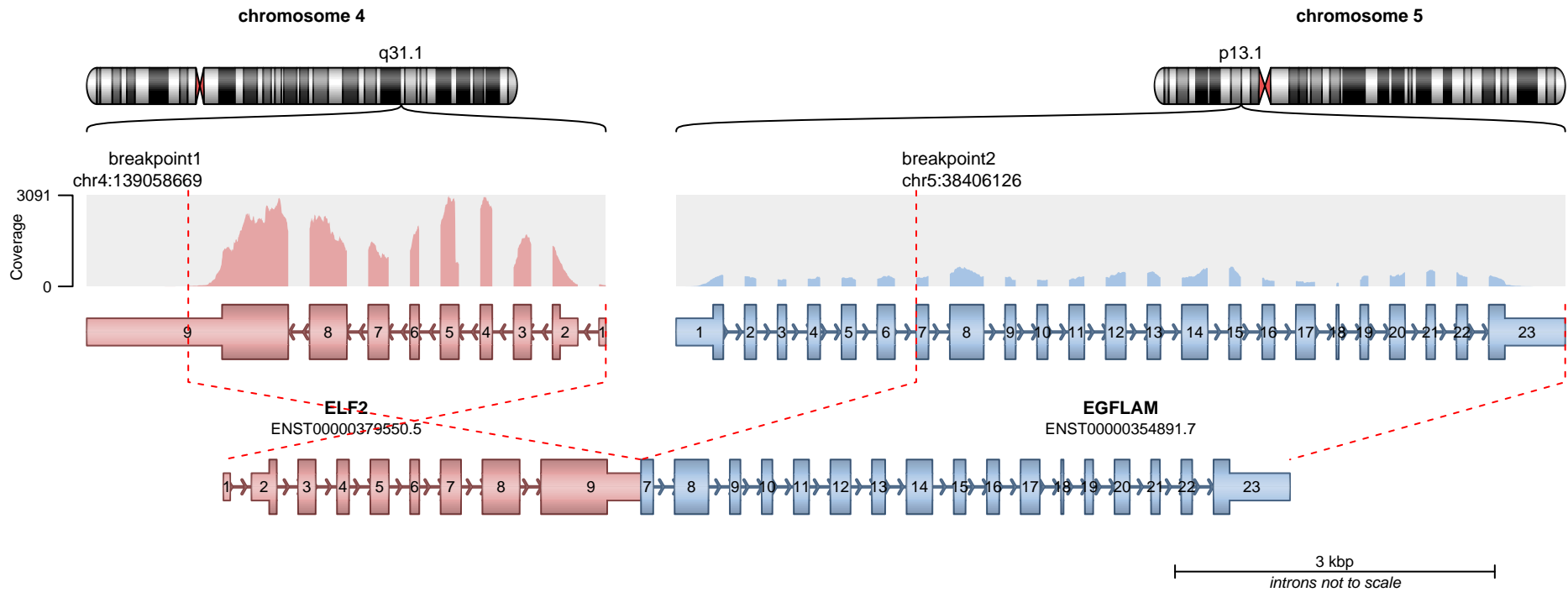

— translocation — deletion
— duplication — inversion

RETAINED PROTEIN DOMAINS
reading frame unclear

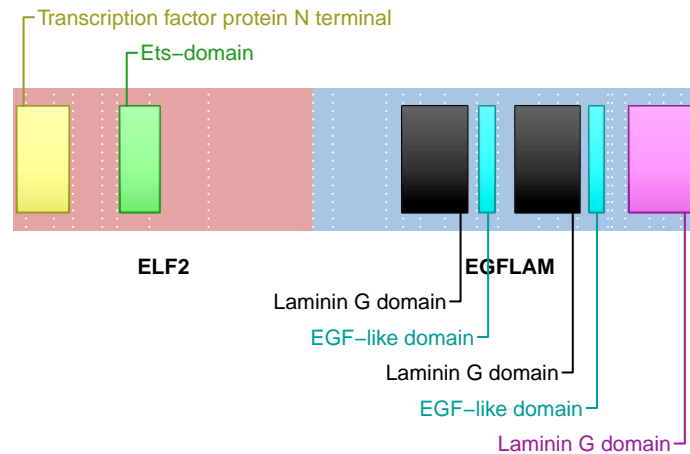

SUPPORTING READ COUNT

Split reads = 9
Discordant mates = 1

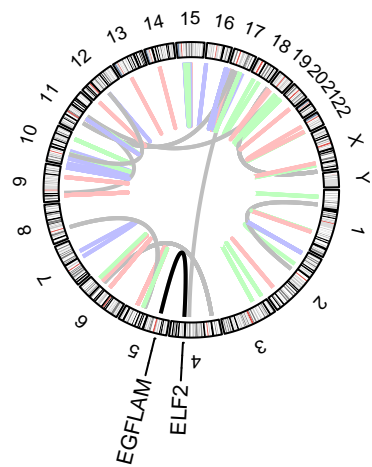
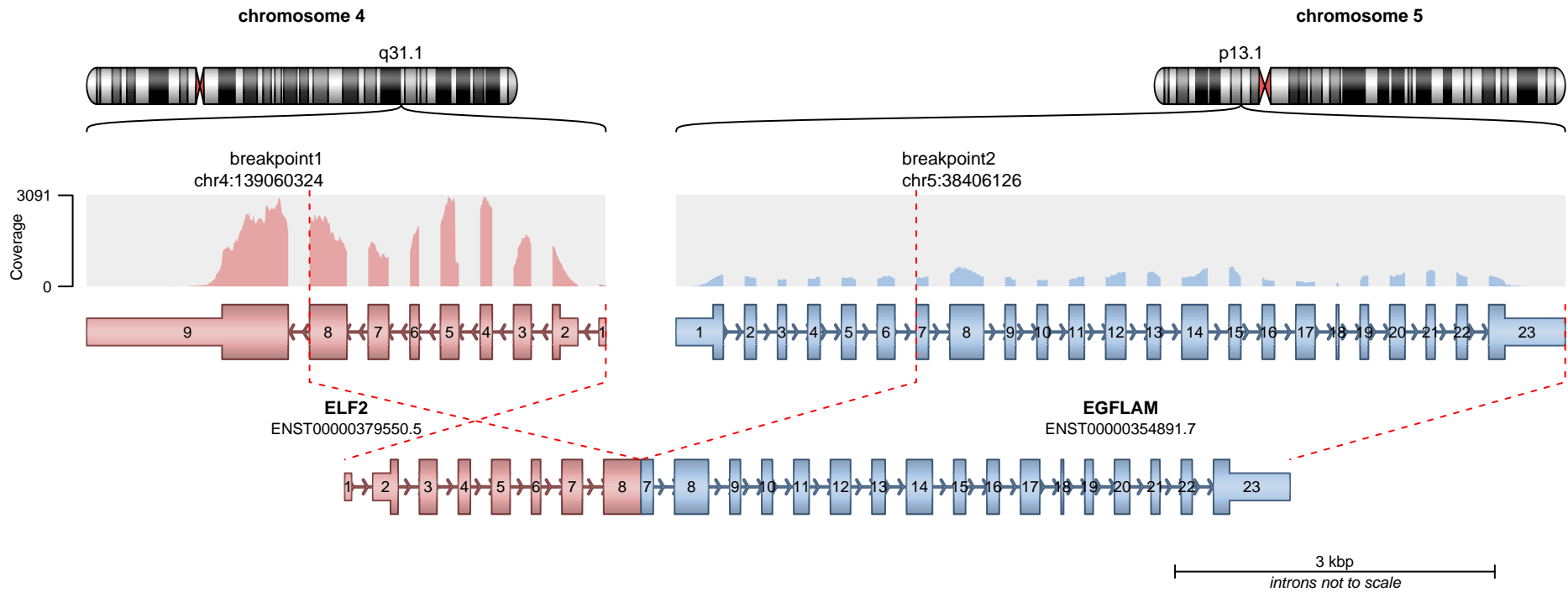

— translocation — deletion
— duplication — inversion

RETAINED PROTEIN DOMAINS
reading frame unclear

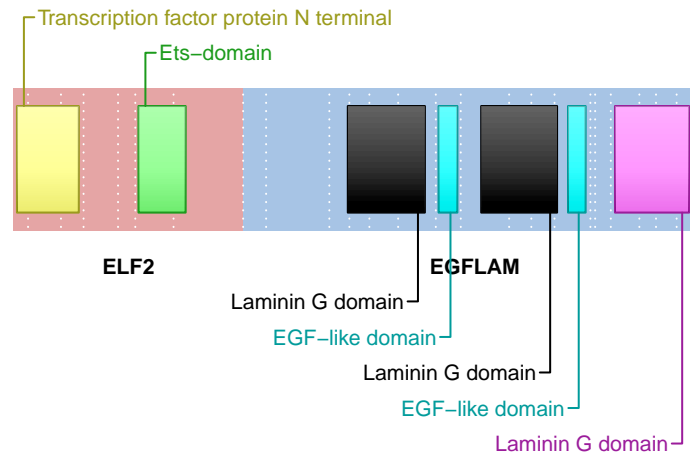

SUPPORTING READ COUNT

Split reads = 1
Discordant mates = 1

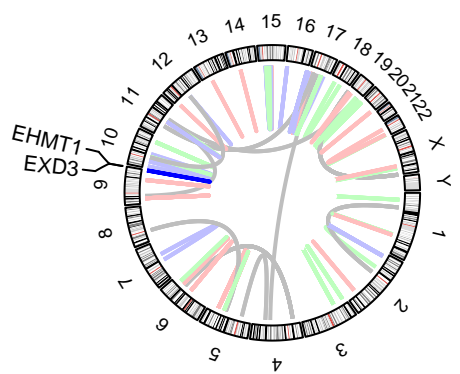
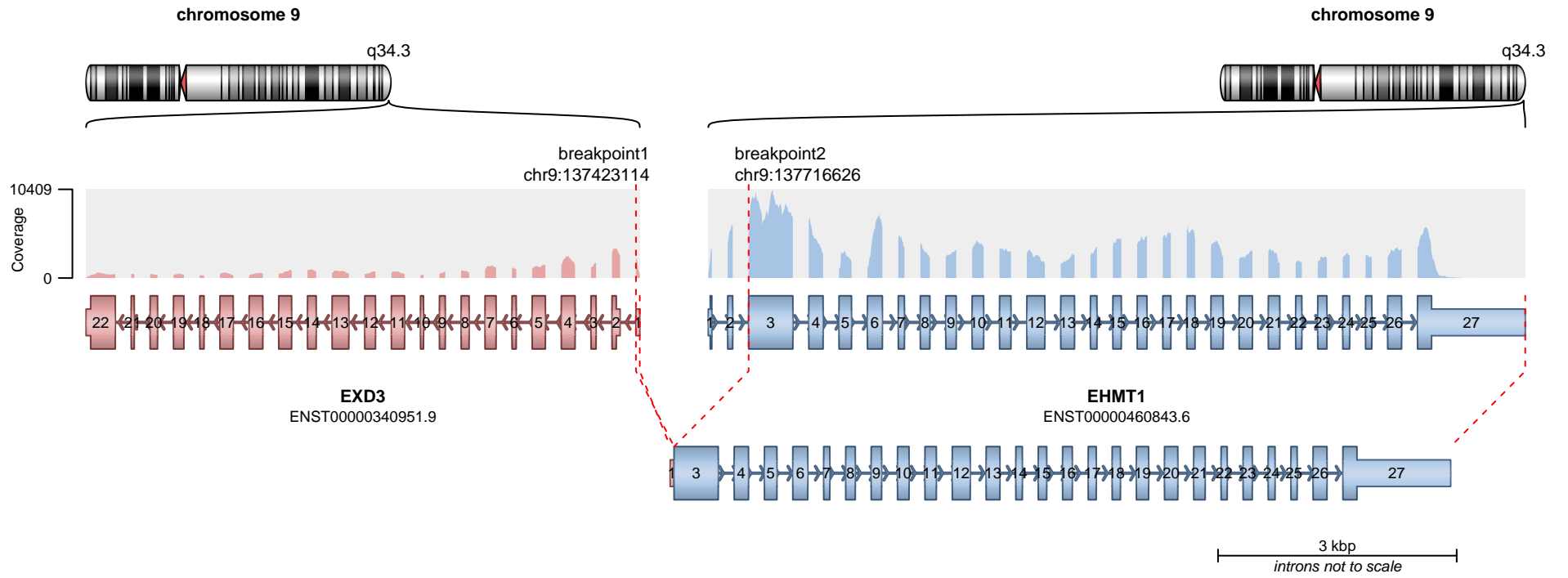

— translocation — deletion
— duplication — inversion

RETAINED PROTEIN DOMAINS
reading frame unclear

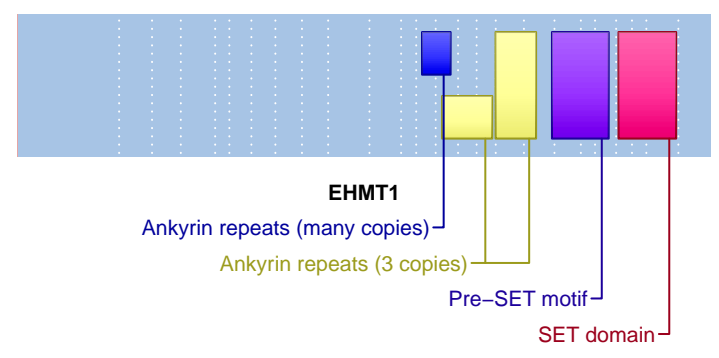

SUPPORTING READ COUNT

Split reads = 9
Discordant mates = 0

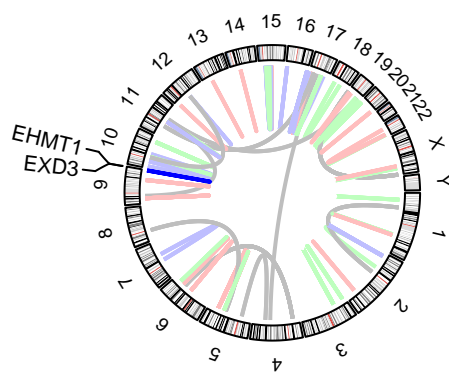
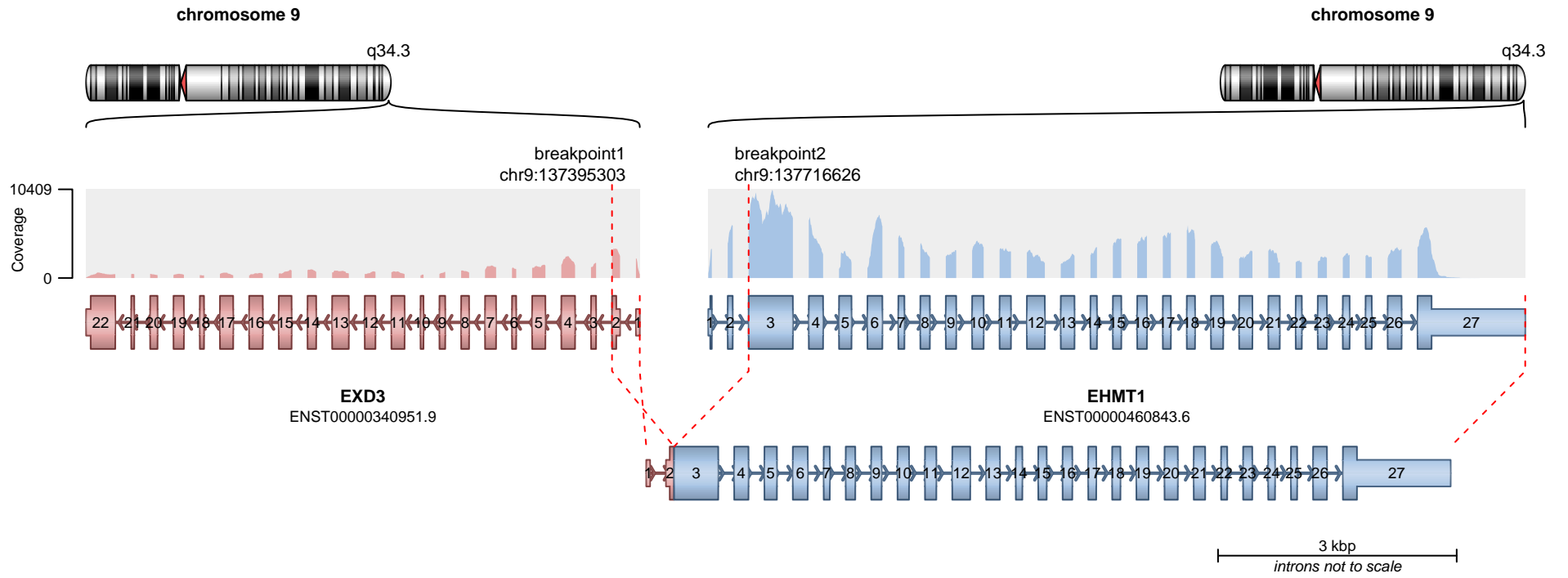

— translocation — deletion
— duplication — inversion

RETAINED PROTEIN DOMAINS
reading frame unclear

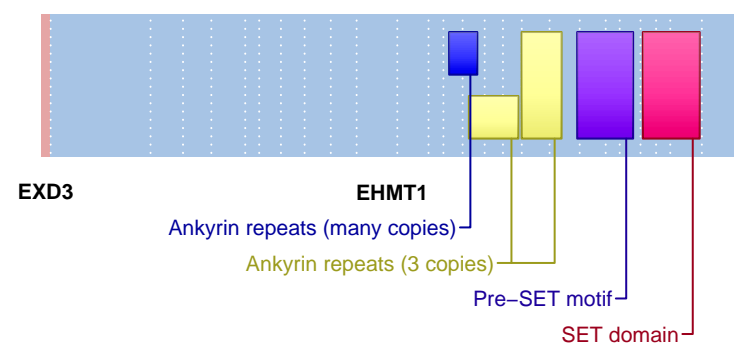

SUPPORTING READ COUNT

Split reads = 1
Discordant mates = 0

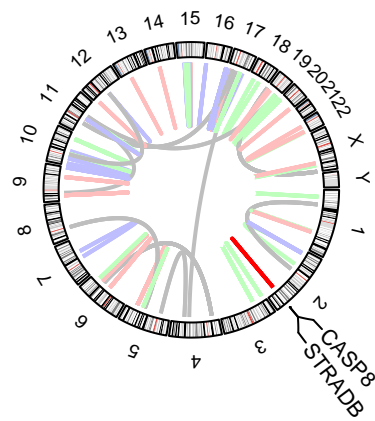
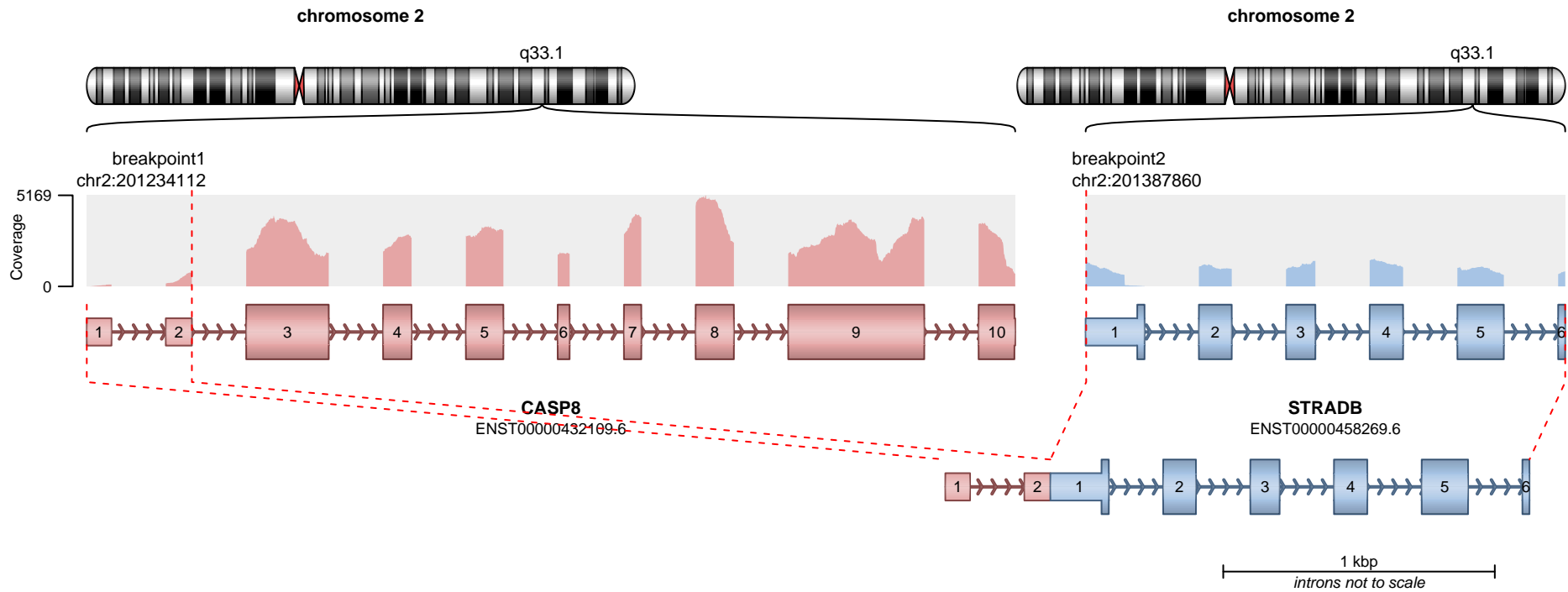

RETAINED PROTEIN DOMAINS
reading frame unclear

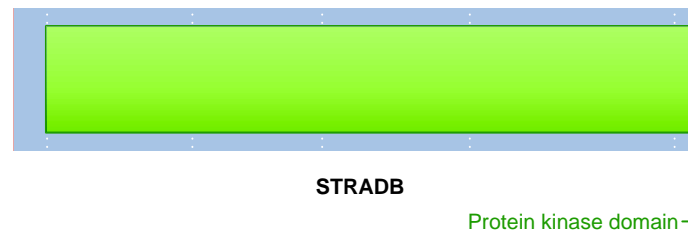

SUPPORTING READ COUNT

Split reads = 8
Discordant mates = 2

— translocation — deletion
— duplication — inversion

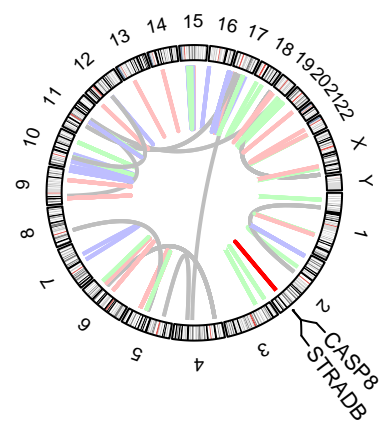
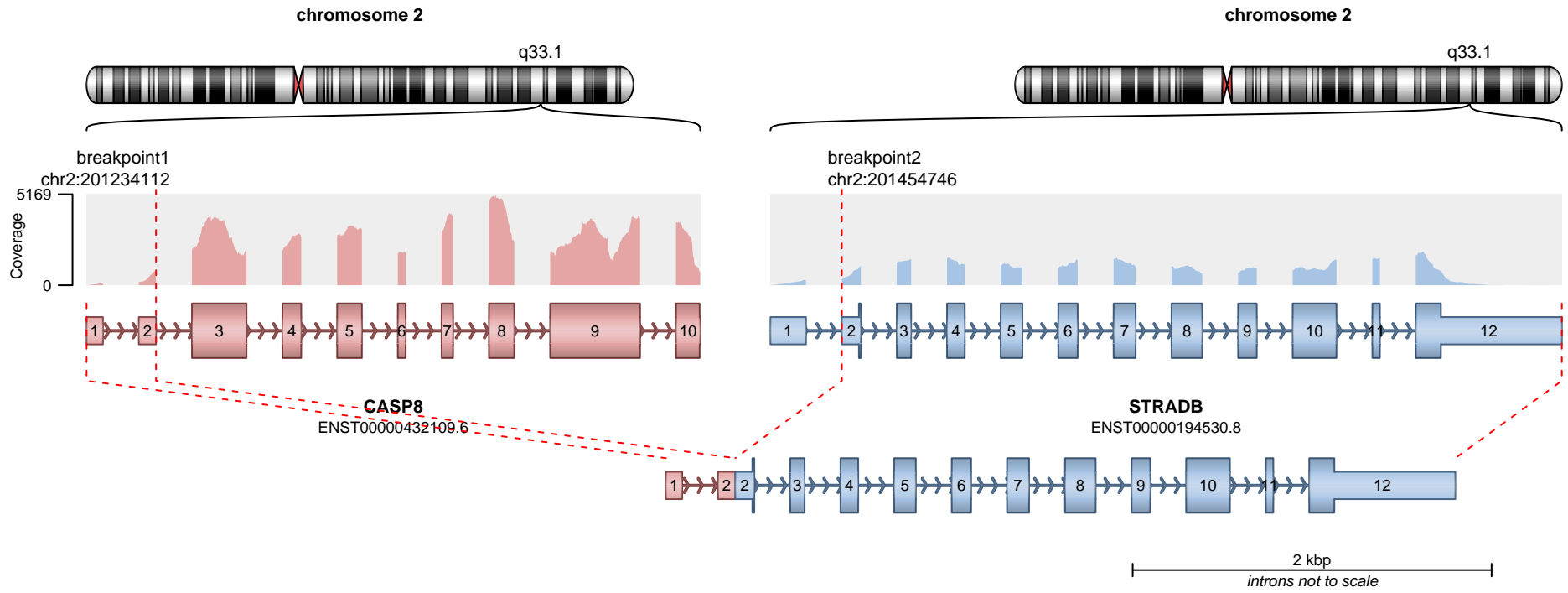

— translocation — deletion
— duplication — inversion

RETAINED PROTEIN DOMAINS
reading frame unclear



SUPPORTING READ COUNT

Split reads = 2
Discordant mates = 2

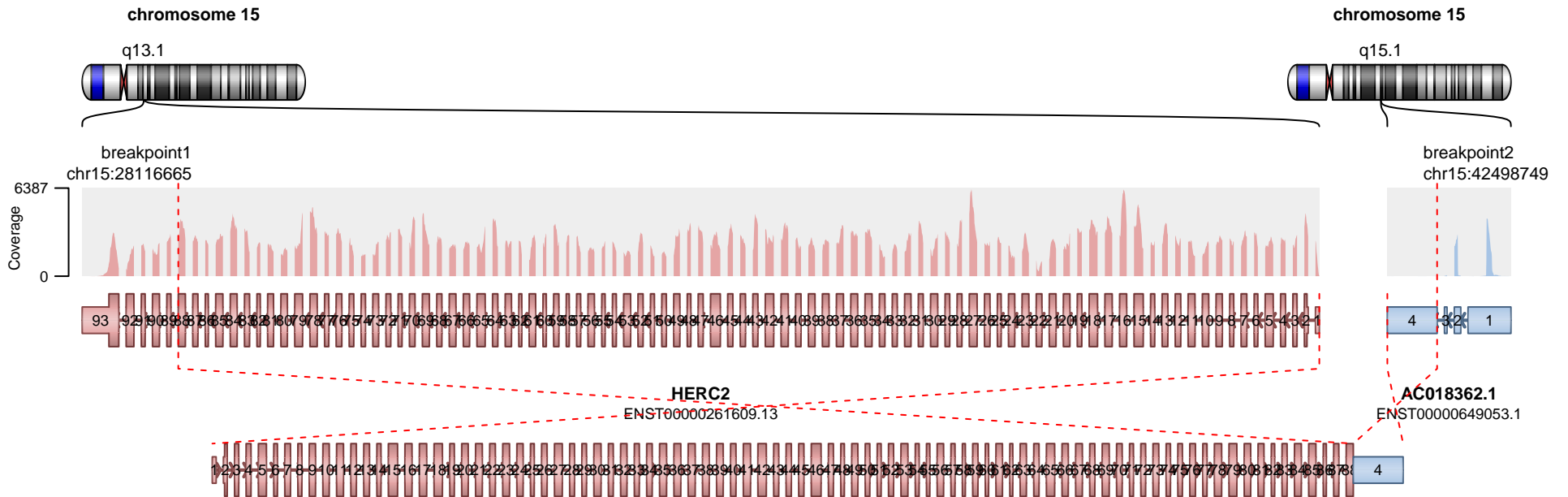

RETAINED PROTEIN DOMAINS
reading frame unclear

7 kbp
introns not to scale

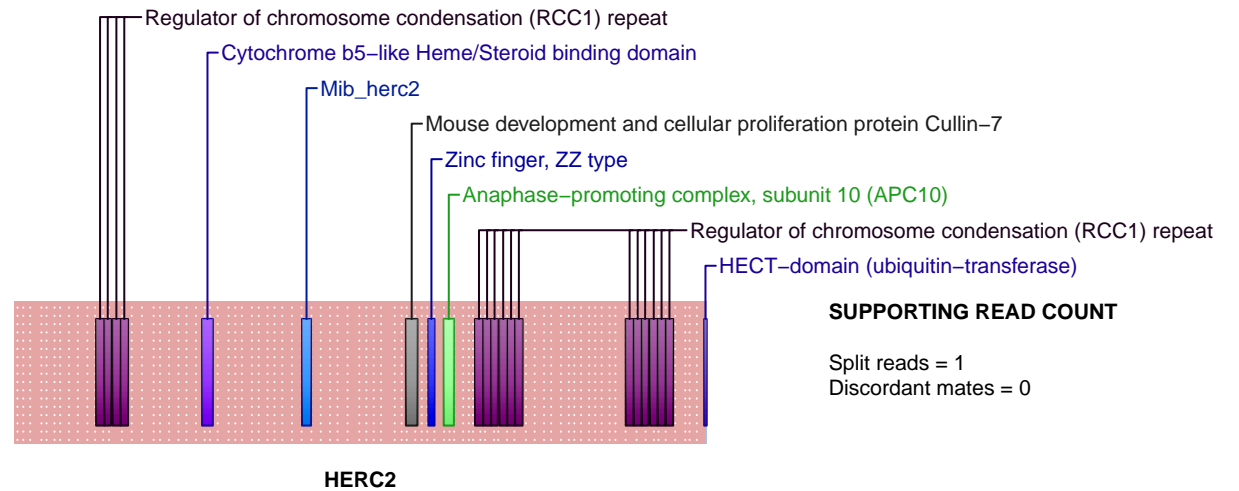
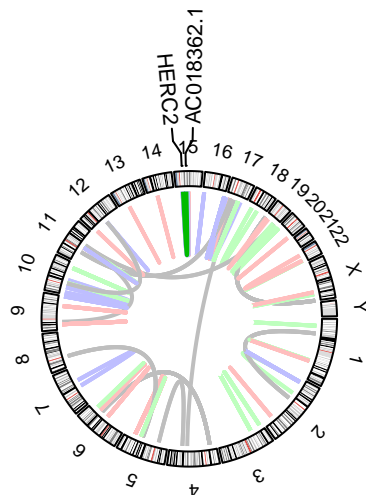

— translocation — deletion
— duplication — inversion